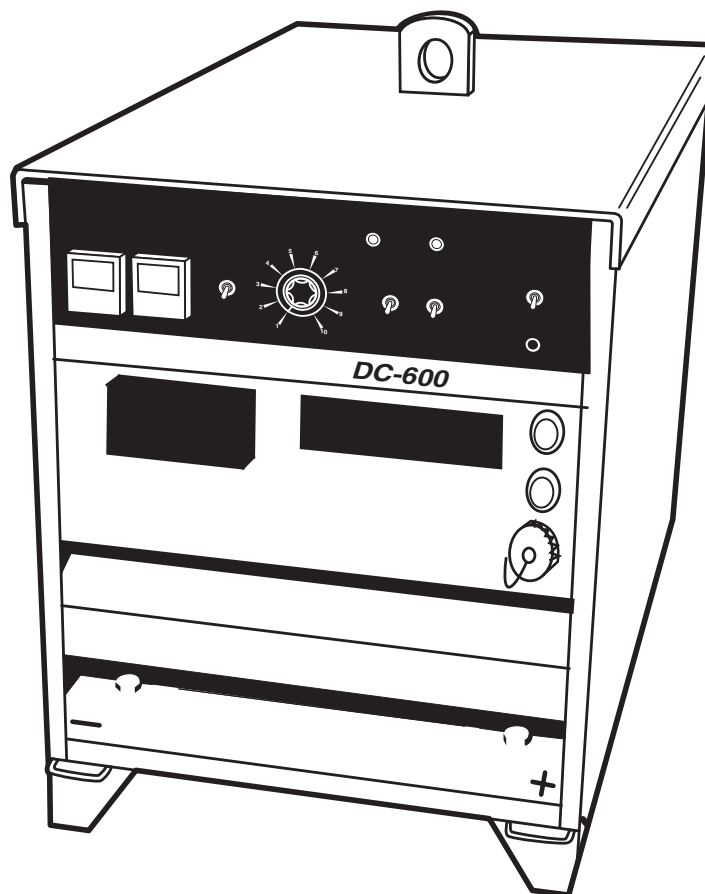

IDEALARC® DC-600

For use with machines having Code Numbers: **10588 to 10701, 11071, 11072, 11129, 11130, 11131, 11132, 11133 and 11140 11335, 11336, 11337, 11338, 11339 11537, 11538, 11539, 11540, 11541, 11568**

Safety Depends on You

Lincoln arc welding and cutting equipment is designed and built with safety in mind. However, your overall safety can be increased by proper installation ... and thoughtful operation on your part. **DO NOT INSTALL, OPERATE OR REPAIR THIS EQUIPMENT WITHOUT READING THIS MANUAL AND THE SAFETY PRECAUTIONS CONTAINED THROUGHOUT.** And, most importantly, think before you act and be careful.

**OPERATOR'S MANUAL**

LINCOLN®
ELECTRIC

Copyright © Lincoln Global Inc.

• World's Leader in Welding and Cutting Products •

• Sales and Service through Subsidiaries and Distributors Worldwide •

Cleveland, Ohio 44117-1199 U.S.A. TEL: 216.481.8100 FAX: 216.486.1751 WEB SITE: www.lincolnelectric.com

⚠ WARNING

⚠ CALIFORNIA PROPOSITION 65 WARNINGS ⚠

Diesel engine exhaust and some of its constituents are known to the State of California to cause cancer, birth defects, and other reproductive harm.

The Above For Diesel Engines

The engine exhaust from this product contains chemicals known to the State of California to cause cancer, birth defects, or other reproductive harm.

The Above For Gasoline Engines

ARC WELDING CAN BE HAZARDOUS. PROTECT YOURSELF AND OTHERS FROM POSSIBLE SERIOUS INJURY OR DEATH. KEEP CHILDREN AWAY. PACEMAKER WEARERS SHOULD CONSULT WITH THEIR DOCTOR BEFORE OPERATING.

Read and understand the following safety highlights. For additional safety information, it is strongly recommended that you purchase a copy of "Safety in Welding & Cutting - ANSI Standard Z49.1" from the American Welding Society, P.O. Box 351040, Miami, Florida 33135 or CSA Standard W117.2-1974. A Free copy of "Arc Welding Safety" booklet E205 is available from the Lincoln Electric Company, 22801 St. Clair Avenue, Cleveland, Ohio 44117-1199.

BE SURE THAT ALL INSTALLATION, OPERATION, MAINTENANCE AND REPAIR PROCEDURES ARE PERFORMED ONLY BY QUALIFIED INDIVIDUALS.



FOR ENGINE powered equipment.

1.a. Turn the engine off before troubleshooting and maintenance work unless the maintenance work requires it to be running.



1.b. Operate engines in open, well-ventilated areas or vent the engine exhaust fumes outdoors.



1.c. Do not add the fuel near an open flame welding arc or when the engine is running. Stop the engine and allow it to cool before refueling to prevent spilled fuel from vaporizing on contact with hot engine parts and igniting. Do not spill fuel when filling tank. If fuel is spilled, wipe it up and do not start engine until fumes have been eliminated.

1.d. Keep all equipment safety guards, covers and devices in position and in good repair. Keep hands, hair, clothing and tools away from V-belts, gears, fans and all other moving parts when starting, operating or repairing equipment.

1.e. In some cases it may be necessary to remove safety guards to perform required maintenance. Remove guards only when necessary and replace them when the maintenance requiring their removal is complete. Always use the greatest care when working near moving parts.



1.f. Do not put your hands near the engine fan. Do not attempt to override the governor or idler by pushing on the throttle control rods while the engine is running.

1.g. To prevent accidentally starting gasoline engines while turning the engine or welding generator during maintenance work, disconnect the spark plug wires, distributor cap or magneto wire as appropriate.



1.h. To avoid scalding, do not remove the radiator pressure cap when the engine is hot.



ELECTRIC AND MAGNETIC FIELDS may be dangerous

2.a. Electric current flowing through any conductor causes localized Electric and Magnetic Fields (EMF). Welding current creates EMF fields around welding cables and welding machines

2.b. EMF fields may interfere with some pacemakers, and welders having a pacemaker should consult their physician before welding.

2.c. Exposure to EMF fields in welding may have other health effects which are now not known.

2.d. All welders should use the following procedures in order to minimize exposure to EMF fields from the welding circuit:

2.d.1. Route the electrode and work cables together - Secure them with tape when possible.

2.d.2. Never coil the electrode lead around your body.

2.d.3. Do not place your body between the electrode and work cables. If the electrode cable is on your right side, the work cable should also be on your right side.

2.d.4. Connect the work cable to the workpiece as close as possible to the area being welded.

2.d.5. Do not work next to welding power source.

IDEALARC® DC-600

LINCOLN
ELECTRIC



ELECTRIC SHOCK can kill.

- 3.a. The electrode and work (or ground) circuits are electrically “hot” when the welder is on. Do not touch these “hot” parts with your bare skin or wet clothing. Wear dry, hole-free gloves to insulate hands.
- 3.b. Insulate yourself from work and ground using dry insulation. Make certain the insulation is large enough to cover your full area of physical contact with work and ground.

In addition to the normal safety precautions, if welding must be performed under electrically hazardous conditions (in damp locations or while wearing wet clothing; on metal structures such as floors, gratings or scaffolds; when in cramped positions such as sitting, kneeling or lying, if there is a high risk of unavoidable or accidental contact with the workpiece or ground) use the following equipment:

- Semiautomatic DC Constant Voltage (Wire) Welder.
 - DC Manual (Stick) Welder.
 - AC Welder with Reduced Voltage Control.
- 3.c. In semiautomatic or automatic wire welding, the electrode, electrode reel, welding head, nozzle or semiautomatic welding gun are also electrically “hot”.
- 3.d. Always be sure the work cable makes a good electrical connection with the metal being welded. The connection should be as close as possible to the area being welded.
- 3.e. Ground the work or metal to be welded to a good electrical (earth) ground.
- 3.f. Maintain the electrode holder, work clamp, welding cable and welding machine in good, safe operating condition. Replace damaged insulation.
- 3.g. Never dip the electrode in water for cooling.
- 3.h. Never simultaneously touch electrically “hot” parts of electrode holders connected to two welders because voltage between the two can be the total of the open circuit voltage of both welders.
- 3.i. When working above floor level, use a safety belt to protect yourself from a fall should you get a shock.
- 3.j. Also see Items 6.c. and 8.



ARC RAYS can burn.

- 4.a. Use a shield with the proper filter and cover plates to protect your eyes from sparks and the rays of the arc when welding or observing open arc welding. Headshield and filter lens should conform to ANSI Z87.1 standards.
- 4.b. Use suitable clothing made from durable flame-resistant material to protect your skin and that of your helpers from the arc rays.
- 4.c. Protect other nearby personnel with suitable, non-flammable screening and/or warn them not to watch the arc nor expose themselves to the arc rays or to hot spatter or metal.



FUMES AND GASES can be dangerous.

- 5.a. Welding may produce fumes and gases hazardous to health. Avoid breathing these fumes and gases. When welding, keep your head out of the fume. Use enough ventilation and/or exhaust at the arc to keep fumes and gases away from the breathing zone. **When welding with electrodes which require special ventilation such as stainless or hard facing (see instructions on container or MSDS) or on lead or cadmium plated steel and other metals or coatings which produce highly toxic fumes, keep exposure as low as possible and within applicable OSHA PEL and ACGIH TLV limits using local exhaust or mechanical ventilation. In confined spaces or in some circumstances, outdoors, a respirator may be required. Additional precautions are also required when welding on galvanized steel.**
5. b. The operation of welding fume control equipment is affected by various factors including proper use and positioning of the equipment, maintenance of the equipment and the specific welding procedure and application involved. Worker exposure level should be checked upon installation and periodically thereafter to be certain it is within applicable OSHA PEL and ACGIH TLV limits.
- 5.c. Do not weld in locations near chlorinated hydrocarbon vapors coming from degreasing, cleaning or spraying operations. The heat and rays of the arc can react with solvent vapors to form phosgene, a highly toxic gas, and other irritating products.
- 5.d. Shielding gases used for arc welding can displace air and cause injury or death. Always use enough ventilation, especially in confined areas, to insure breathing air is safe.
- 5.e. Read and understand the manufacturer’s instructions for this equipment and the consumables to be used, including the material safety data sheet (MSDS) and follow your employer’s safety practices. MSDS forms are available from your welding distributor or from the manufacturer.
- 5.f. Also see item 1.b.

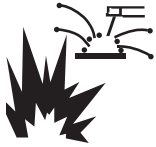

WELDING and CUTTING SPARKS can cause fire or explosion.

6.a. Remove fire hazards from the welding area. If this is not possible, cover them to prevent the welding sparks from starting a fire.

Remember that welding sparks and hot materials from welding can easily go through small cracks and openings to adjacent areas. Avoid welding near hydraulic lines. Have a fire extinguisher readily available.

- 6.b. Where compressed gases are to be used at the job site, special precautions should be used to prevent hazardous situations. Refer to "Safety in Welding and Cutting" (ANSI Standard Z49.1) and the operating information for the equipment being used.
- 6.c. When not welding, make certain no part of the electrode circuit is touching the work or ground. Accidental contact can cause overheating and create a fire hazard.
- 6.d. Do not heat, cut or weld tanks, drums or containers until the proper steps have been taken to insure that such procedures will not cause flammable or toxic vapors from substances inside. They can cause an explosion even though they have been "cleaned". For information, purchase "Recommended Safe Practices for the Preparation for Welding and Cutting of Containers and Piping That Have Held Hazardous Substances", AWS F4.1 from the American Welding Society (see address above).
- 6.e. Vent hollow castings or containers before heating, cutting or welding. They may explode.
- 6.f. Sparks and spatter are thrown from the welding arc. Wear oil free protective garments such as leather gloves, heavy shirt, cuffless trousers, high shoes and a cap over your hair. Wear ear plugs when welding out of position or in confined places. Always wear safety glasses with side shields when in a welding area.
- 6.g. Connect the work cable to the work as close to the welding area as practical. Work cables connected to the building framework or other locations away from the welding area increase the possibility of the welding current passing through lifting chains, crane cables or other alternate circuits. This can create fire hazards or overheat lifting chains or cables until they fail.
- 6.h. Also see item 1.c.
- 6.i. Read and follow NFPA 51B "Standard for Fire Prevention During Welding, Cutting and Other Hot Work", available from NFPA, 1 Batterymarch Park, PO box 9101, Quincy, Ma 022690-9101.
- 6.j. Do not use a welding power source for pipe thawing.



CYLINDER may explode if damaged.

7.a. Use only compressed gas cylinders containing the correct shielding gas for the process used and properly operating regulators designed for the gas and pressure used. All hoses, fittings, etc. should be suitable for the application and maintained in good condition.

- 7.b. Always keep cylinders in an upright position securely chained to an undercarriage or fixed support.
- 7.c. Cylinders should be located:
 - Away from areas where they may be struck or subjected to physical damage.
 - A safe distance from arc welding or cutting operations and any other source of heat, sparks, or flame.
- 7.d. Never allow the electrode, electrode holder or any other electrically "hot" parts to touch a cylinder.
- 7.e. Keep your head and face away from the cylinder valve outlet when opening the cylinder valve.
- 7.f. Valve protection caps should always be in place and hand tight except when the cylinder is in use or connected for use.
- 7.g. Read and follow the instructions on compressed gas cylinders, associated equipment, and CGA publication P-1, "Precautions for Safe Handling of Compressed Gases in Cylinders," available from the Compressed Gas Association 1235 Jefferson Davis Highway, Arlington, VA 22202.



FOR ELECTRICALLY powered equipment.

- 8.a. Turn off input power using the disconnect switch at the fuse box before working on the equipment.
- 8.b. Install equipment in accordance with the U.S. National Electrical Code, all local codes and the manufacturer's recommendations.
- 8.c. Ground the equipment in accordance with the U.S. National Electrical Code and the manufacturer's recommendations.

Refer to <http://www.lincolnelectric.com/safety> for additional safety information.

PRÉCAUTIONS DE SÛRETÉ

Pour votre propre protection lire et observer toutes les instructions et les précautions de sûreté spécifiques qui paraissent dans ce manuel aussi bien que les précautions de sûreté générales suivantes:

Sûreté Pour Soudage A L'Arc

1. Protégez-vous contre la secousse électrique:
 - a. Les circuits à l'électrode et à la pièce sont sous tension quand la machine à souder est en marche. Eviter toujours tout contact entre les parties sous tension et la peau nue ou les vêtements mouillés. Porter des gants secs et sans trous pour isoler les mains.
 - b. Faire très attention de bien s'isoler de la masse quand on soude dans des endroits humides, ou sur un plancher métallique ou des grilles métalliques, principalement dans les positions assis ou couché pour lesquelles une grande partie du corps peut être en contact avec la masse.
 - c. Maintenir le porte-électrode, la pince de masse, le câble de soudage et la machine à souder en bon et sûr état de fonctionnement.
 - d. Ne jamais plonger le porte-électrode dans l'eau pour le refroidir.
 - e. Ne jamais toucher simultanément les parties sous tension des porte-électrodes connectés à deux machines à souder parce que la tension entre les deux pinces peut être le total de la tension à vide des deux machines.
 - f. Si on utilise la machine à souder comme une source de courant pour soudage semi-automatique, ces précautions pour le porte-électrode s'appliquent aussi au pistolet de soudage.
2. Dans le cas de travail au dessus du niveau du sol, se protéger contre les chutes dans le cas où on recoit un choc. Ne jamais enrouler le câble-électrode autour de n'importe quelle partie du corps.
3. Un coup d'arc peut être plus sévère qu'un coup de soleil, donc:
 - a. Utiliser un bon masque avec un verre filtrant approprié ainsi qu'un verre blanc afin de se protéger les yeux du rayonnement de l'arc et des projections quand on soude ou quand on regarde l'arc.
 - b. Porter des vêtements convenables afin de protéger la peau de soudeur et des aides contre le rayonnement de l'arc.
 - c. Protéger l'autre personnel travaillant à proximité au soudage à l'aide d'écrans appropriés et non-inflammables.
4. Des gouttes de laitier en fusion sont émises de l'arc de soudage. Se protéger avec des vêtements de protection libres de l'huile, tels que les gants en cuir, chemise épaisse, pantalons sans revers, et chaussures montantes.
5. Toujours porter des lunettes de sécurité dans la zone de soudage. Utiliser des lunettes avec écrans latéraux dans les zones où l'on pique le laitier.

6. Eloigner les matériaux inflammables ou les recouvrir afin de prévenir tout risque d'incendie dû aux étincelles.
7. Quand on ne soude pas, poser la pince à un endroit isolé de la masse. Un court-circuit accidentel peut provoquer un échauffement et un risque d'incendie.
8. S'assurer que la masse est connectée le plus près possible de la zone de travail qu'il est pratique de le faire. Si on place la masse sur la charpente de la construction ou d'autres endroits éloignés de la zone de travail, on augmente le risque de voir passer le courant de soudage par les chaînes de levage, câbles de grue, ou autres circuits. Cela peut provoquer des risques d'incendie ou d'échauffement des chaînes et des câbles jusqu'à ce qu'ils se rompent.
9. Assurer une ventilation suffisante dans la zone de soudage. Ceci est particulièrement important pour le soudage de tôles galvanisées plombées, ou cadmiées ou tout autre métal qui produit des fumées toxiques.
10. Ne pas souder en présence de vapeurs de chlore provenant d'opérations de dégraissage, nettoyage ou pistolage. La chaleur ou les rayons de l'arc peuvent réagir avec les vapeurs du solvant pour produire du phosgène (gas fortement toxique) ou autres produits irritants.
11. Pour obtenir de plus amples renseignements sur la sûreté, voir le code "Code for safety in welding and cutting" CSA Standard W 117.2-1974.

PRÉCAUTIONS DE SÛRETÉ POUR LES MACHINES À SOUDER À TRANSFORMATEUR ET À REDRESSEUR

1. Relier à la terre le châssis du poste conformément au code de l'électricité et aux recommandations du fabricant. Le dispositif de montage ou la pièce à souder doit être branché à une bonne mise à la terre.
2. Autant que possible, l'installation et l'entretien du poste seront effectués par un électricien qualifié.
3. Avant de faire des travaux à l'intérieur de poste, la débrancher à l'interrupteur à la boîte de fusibles.
4. Garder tous les couvercles et dispositifs de sûreté à leur place.

Thank You

for selecting a **QUALITY** product by Lincoln Electric. We want you to take pride in operating this Lincoln Electric Company product ... as much pride as we have in bringing this product to you!

CUSTOMER ASSISTANCE POLICY

The business of The Lincoln Electric Company is manufacturing and selling high quality welding equipment, consumables, and cutting equipment. Our challenge is to meet the needs of our customers and to exceed their expectations. On occasion, purchasers may ask Lincoln Electric for advice or information about their use of our products. We respond to our customers based on the best information in our possession at that time. Lincoln Electric is not in a position to warrant or guarantee such advice, and assumes no liability, with respect to such information or advice. We expressly disclaim any warranty of any kind, including any warranty of fitness for any customer's particular purpose, with respect to such information or advice. As a matter of practical consideration, we also cannot assume any responsibility for updating or correcting any such information or advice once it has been given, nor does the provision of information or advice create, expand or alter any warranty with respect to the sale of our products.

Lincoln Electric is a responsive manufacturer, but the selection and use of specific products sold by Lincoln Electric is solely within the control of, and remains the sole responsibility of the customer. Many variables beyond the control of Lincoln Electric affect the results obtained in applying these types of fabrication methods and service requirements.

Subject to Change – This information is accurate to the best of our knowledge at the time of printing. Please refer to www.lincolnelectric.com for any updated information.

Please Examine Carton and Equipment For Damage Immediately

When this equipment is shipped, title passes to the purchaser upon receipt by the carrier. Consequently, Claims for material damaged in shipment must be made by the purchaser against the transportation company at the time the shipment is received.

Please record your equipment identification information below for future reference. This information can be found on your machine nameplate.

Product _____

Model Number _____

Code Number or Date Code _____

Serial Number _____

Date Purchased _____

Where Purchased _____

Whenever you request replacement parts or information on this equipment, always supply the information you have recorded above. The code number is especially important when identifying the correct replacement parts.

On-Line Product Registration

- Register your machine with Lincoln Electric either via fax or over the Internet.
- For faxing: Complete the form on the back of the warranty statement included in the literature packet accompanying this machine and fax the form per the instructions printed on it.
- For On-Line Registration: Go to our **WEB SITE at www.lincolnelectric.com**. Choose "Support" and then "Register Your Product". Please complete the form and submit your registration.

Read this Operators Manual completely before attempting to use this equipment. Save this manual and keep it handy for quick reference. Pay particular attention to the safety instructions we have provided for your protection. The level of seriousness to be applied to each is explained below:

WARNING

This statement appears where the information **must** be followed **exactly** to avoid **serious personal injury** or **loss of life**.

CAUTION

This statement appears where the information **must** be followed to avoid **minor personal injury** or **damage to this equipment**.

Installation	Section A
Technical Specifications	A-1
Safety Precautions	A-2
Select Proper Location.....	A-2
Limit on Stacking	A-2
Stacking.....	A-2
Tilting	A-2
Electrical Input Connections	A-3
Fuses and Wire Sizes.....	A-3
Ground Connection	A-3
Input Power Supply Connections.....	A-3
Reconnect Procedure	A-4
Output Connections	A-7
Electrode, Work and #21 Lead	A-7
Auxiliary Power and Control Connections	A-8
<hr/>	
Operation	Section B
Safety Precautions	B-1
General Description	B-2
Recommended Processes and Equipment	B-2
Design Features and Advantages	B-2
Welding Capability	B-3
Meaning of Graphical Symbols on Case Front.....	B-3
Meaning of Graphical Symbols on Rating Plate	B-4
Meaning of Graphical Symbol for Ground Connection	B-4
Controls and Settings	B-4, B-5
Auxiliary Power in MS - Receptacle.....	B-6
Overload, Overcurrent and Fault Protection.....	B-6
Operating Steps	B-7
Remote Control of Machine Operation	B-7
Welding Procedure Recommendations	B-7
Semi-Automatic and Automatic Wire Feeding with a IDEALARC® DC-600 and Wire Feeders.....	B-8
NA-3 Automatic Wire Feeder	B-8
NA-5 Automatic Wire Feeder	B-10
LN-8 Semi-Automatic Wire Feeder	B-10
LN-7 & LN-9 Semi-Automatic Wire Feeders	B-10
<hr/>	
Accessories	Section C
Wire Feeders and Tractors.....	C-1
Field Installed Options.....	C-1
Remote Output Control (K775 or K857).....	C-1
Remote Control Adapter Cable (K864)	C-1
Undercarriages (K817P, K842).....	C-1
Paralleling Kit (K1611-1)	C-1
TIG Module (K930-2)	C-1
Factory or Field Installed Options.....	C-1
Multi-Process Switch (K804-1).....	C-1
Connections for Semi-Automatic or Automatic Wire Feeder Control	C-3

	Page
Maintenance	Section D
Safety Precautions	D-1
Routine and Periodic Maintenance.....	D-2
<hr/>	
Troubleshooting	Section E
Safety Precautions.....	E-1
How to Use Troubleshooting Guide.....	E-1
Troubleshooting Guide	E-2
<hr/>	
Wiring Diagrams, Connection Diagrams and Dimension Prints.....	Section F
<hr/>	
Parts List	P-349 Series

TECHNICAL SPECIFICATIONS – IDEALARC® DC-600

INPUT - THREE PHASE ONLY					
<u>Standard Volatge</u>	<u>Input Current at Rated Output</u>				
	<u>100% Duty Cycle</u>	<u>60% Duty Cycle</u>	<u>50% Duty Cycle</u>		
230/460/60	108/54	122/61	134/67		
230/460/575/60	108/54/43	122/61/49	134/67/54		
460/60	54	61	67		
575/60	43	49	54		
220/380/440/50/60	116/67/58	128/74/64	138/80/69		
380/500/50/60	67/51	74/56	80/61		
440/50/60	58	64	69		
200/400/50/60	128/64	140/70	152/76		
415/50/60	62	68	73		
RATED OUTPUT					
<u>Duty Cycle</u>	<u>Amps</u>		<u>Volts at Rated Amperes</u>		
100% Duty Cycle	600		44		
60% Duty Cycle	680		44		
50% Duty Cycle	750		44		
OUTPUT					
<u>Output Range</u>	<u>Maximum Open Circuit Voltage</u>		<u>Auxiliary Power</u>		
70A/13V-780A/44V (CV) 90A/24V-780A/44V (CC)	72V for 60 HZ models 69V for 50/60 HZ models		See the OPERATION section for Auxiliary Power information by model		
RECOMMENDED INPUT WIRE AND FUSE SIZES					
<u>INPUT VOLTAGE / FREQUENCY</u>	<u>HERTZ</u>	<u>INPUT AMPERE RATING ON NAMEPLATE</u>	<u>TYPE 75°C COPPER WIRE IN CONDUIT AWG(IEC-MM²) SIZES 30°C (86°F) Ambient</u>	<u>TYPE 75°C GROUND WIRE IN CONDUIT AWG(IEC-MM²) SIZES</u>	<u>TYPE 75°C (SUPER LAG) OR BREAKER SIZE (AMPS)¹</u>
230	60	108	2 (34)	6 (14)	175 Amp
460	60	54	6 (14)	8 (8.4)	90 Amp
575	60	43	8 (8.4)	8 (8.4)	70 Amp
200	50/60	128	1 (43)	6 (14)	175 Amp
220	50/60	116	2 (34)	6 (14)	175 Amp
380	50/60	67	6 (14)	8 (8.4)	100 Amp
400	50/60	64	6 (14)	8 (8.4)	100 Amp
415	50/60	61	6 (14)	8 (8.4)	100 Amp
440	50/60	58	6 (14)	8 (8.4)	90 Amp
500	50/60	51	8 (8.4)	8 (8.4)	80 Amp
PHYSICAL DIMENSIONS					
<u>HEIGHT</u>	<u>WIDTH</u>	<u>DEPTH</u>	<u>WEIGHT</u>		
30.75 in 781 mm	22.25 in 567 mm	39.0 in 988 mm	522 lbs. 237 kg.		

¹Also called "inverse time" or "thermal/magnetic" circuit breakers; circuit breakers which have a delay in tripping action that decreases as the magnitude of the current increases.

SAFETY PRECAUTIONS

Read entire Installation Section before installing the IDEALARC® DC-600.

ELECTRIC SHOCK CAN KILL.

⚠ WARNING



- Only qualified personnel should install this machine.
- Turn the input power OFF at the disconnect switch or fuse box before working on the equipment.

- Do not touch electrically hot parts.
- Always connect the IDEALARC IDEALARC® DC-600 grounding terminal to a good electrical earth ground.
- Set the IDEALARC® DC-600 Power ON/OFF PUSH BUTTON to the OFF position when connecting power cord to input power.

SELECT PROPER LOCATION

Place the welder where clean cooling air can freely circulate in through the front louvers and out through the rear louvers. Dirt, dust or any foreign material that can be drawn into the welder should be kept at a minimum. Failure to observe these precautions can result in excessive operating temperatures and nuisance shut-downs.

LIMIT ON STACKING

⚠ WARNING

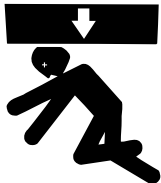

FALLING EQUIPMENT can cause injury.

- Lift only with equipment of adequate lifting capacity.
- Be sure machine is stable when lifting.
- Do not lift this machine using lift bail if it is equipped with a heavy accessory such as trailer or gas cylinder.
- Do not lift machine if lift bail is damaged.
- Do not operate machine while suspended from lift bail.

- Do not stack more than three high.
- Do not stack the IDEALARC® DC-600 on top of any other machine.

STACKING

Three IDEALARC® DC-600 machines can be stacked.

DO NOT stack more than three machines in one grouping.

DO NOT stack the IDEALARC® DC-600 on another type of machine.

Follow these guidelines when stacking:

1. Select a firm, level surface capable of supporting the total weight of up to three machines (1570 pounds/712 kilograms).
2. Set the bottom machine in place.
3. Stack the second machine on top of it by aligning the two holes in the base rails of the second machine with the two pins on top front of the bottom machine.
4. Repeat process for third machine.

NOTE: The machines must be stacked with the Case Front of each machine flush with each other. See Figure A.1.

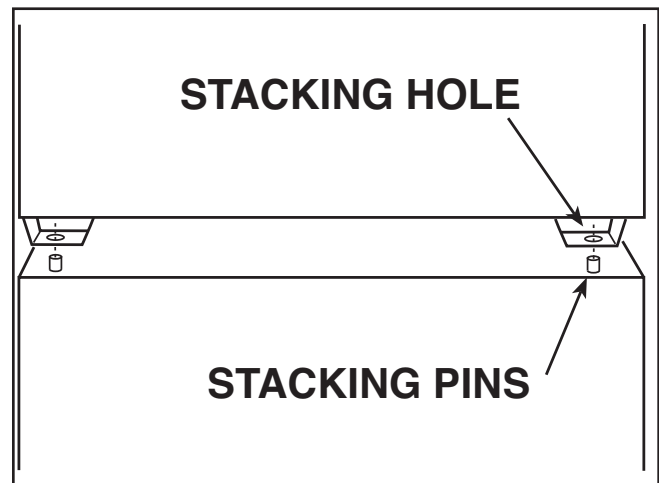

FIGURE A.1 - Stacking IDEALARC® DC-600 machines

TILTING

The IDEALARC® DC-600 must be placed on a stable, level surface so it will not topple over.

ELECTRICAL INPUT CONNECTIONS

Before installing the machine check that the input supply voltage, phase, and frequency are the same as the voltage, phase, and frequency as specified on the welder Rating Plate located on the Case Back Assembly. Input power supply entry is through the hole in the Case Back Assembly. See Figure A.2 for the location of the machine's input cable entry opening, Input Contactor (CR1), and reconnect panel assembly for dual voltage machines.

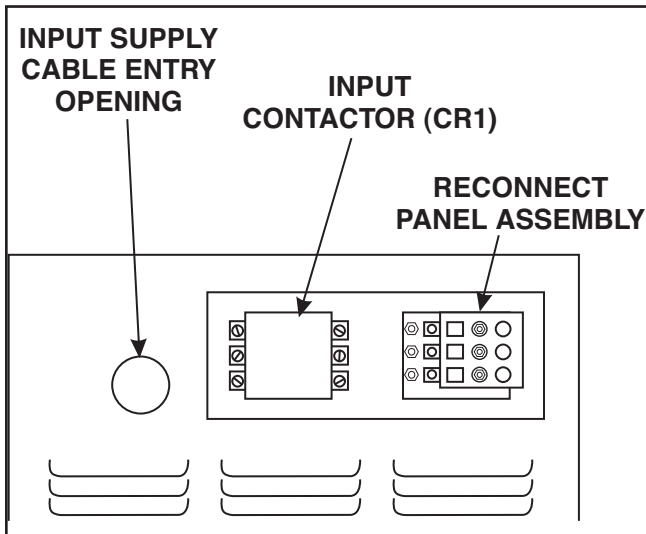

FIGURE A.2 - Rear Panel

FUSE AND WIRE SIZES

Protect the input circuit with the super lag fuses or delay type circuit breakers listed on the Technical Specifications page of this manual for the machine being used. They are also called inverse time or thermal/magnetic circuit breakers.

DO NOT use fuses or circuit breakers with a lower amp rating than recommended. This can result in “nuisance” tripping caused by inrush current even when machine is not being used for welding at high output currents.

Use input and grounding wire sizes that meet local electrical codes or see the Technical Specifications page in this manual.

GROUND CONNECTION

Ground the frame of the machine. A ground terminal marked with the symbol (\oplus) is located inside the Case Back of the machine near the input contactor. Access to the Input Box Assembly is at the upper rear of the machine. See your local and national electrical codes for proper grounding methods.

INPUT POWER SUPPLY CONNECTIONS

A qualified electrician should connect the input power supply leads.

1. Follow all national and local electrical codes.
2. Use a three-phase line.
3. Remove Input Access Door at upper rear of machine.
4. Follow Input Supply Connection Diagram located on the inside of the door.
5. Connect the three-phase AC power supply leads L1, L2, and L3 to the input contactor terminals in the Input Box Assembly by passing them thru the three aligned .50” diameter holes in the baffle and tighten them in the terminal connectors. Be sure to close the baffle by inserting the tab into the slot in the baffle. See Figure A.3.

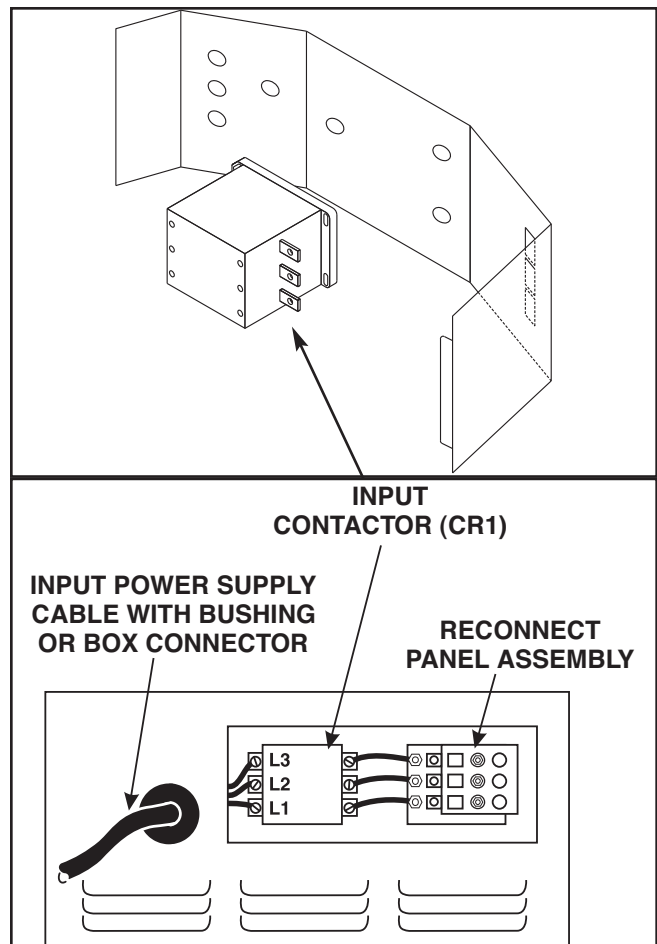

FIGURE A.3 - Input Power Supply Connections

RECONNECT PROCEDURE

Multiple voltage machines are shipped connected to the highest input voltage listed on the machine's rating plate. Before installing the machine, check that the Reconnect Panel in the Input Box Assembly is connected for the proper voltage.

⚠ CAUTION

Failure to follow these instructions can cause immediate failure of components within the machine.

When powering welder from a generator be sure to turn off welder first, before generator is shut down, in order to prevent damage to the welder

To reconnect a multiple voltage machine to a different voltage, remove input power and change the position of the reconnect board on the Reconnect Panel. Follow The Input Connection Diagram located on the inside of Case Back Input Access Door. These connection diagrams for the following codes are listed below.

1. For Dual Voltage except 380/500-460/575, see Figure A.4. (M15009)
2. For 220/380/460, see Figure A.5. (M15010)
3. For 380/500-460/575, see Figure A.6. (M15011)
4. For 460 and 440 Single Voltage, see Figure A.7. (S17894)
5. For 230/460/575, see Figure A.8. (M15666)
6. For Voltages not listed, see the Input Connection Diagram pasted on the inside of the Case Back Input Access Door.

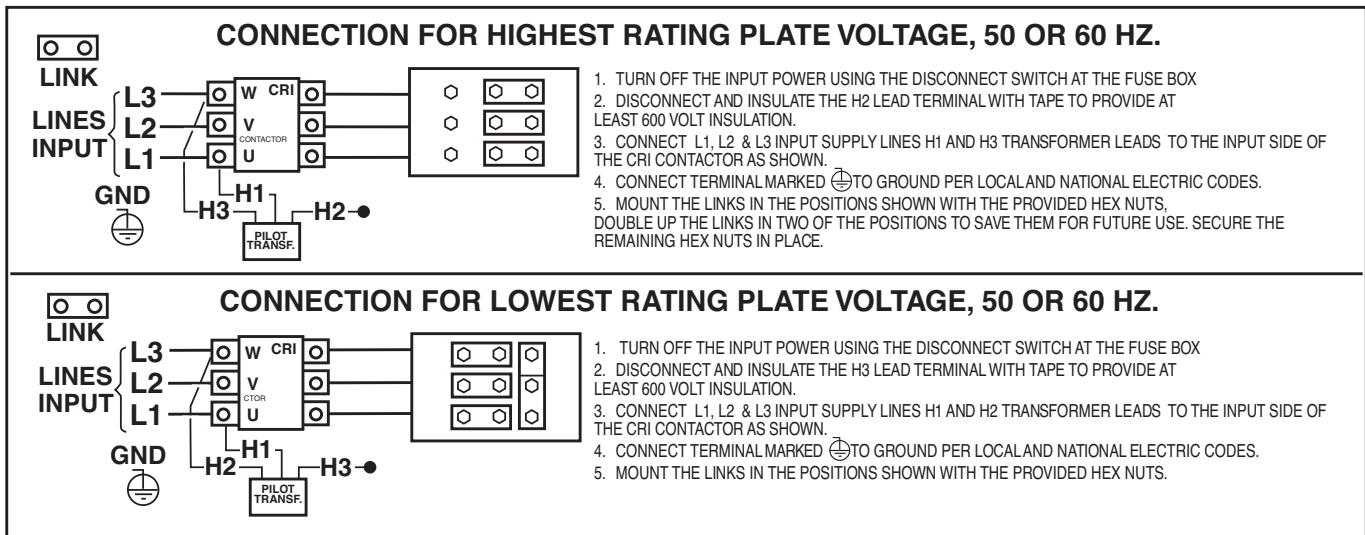

FIGURE A.4-Reconnect Panel Board Positions for Dual Voltage Machines

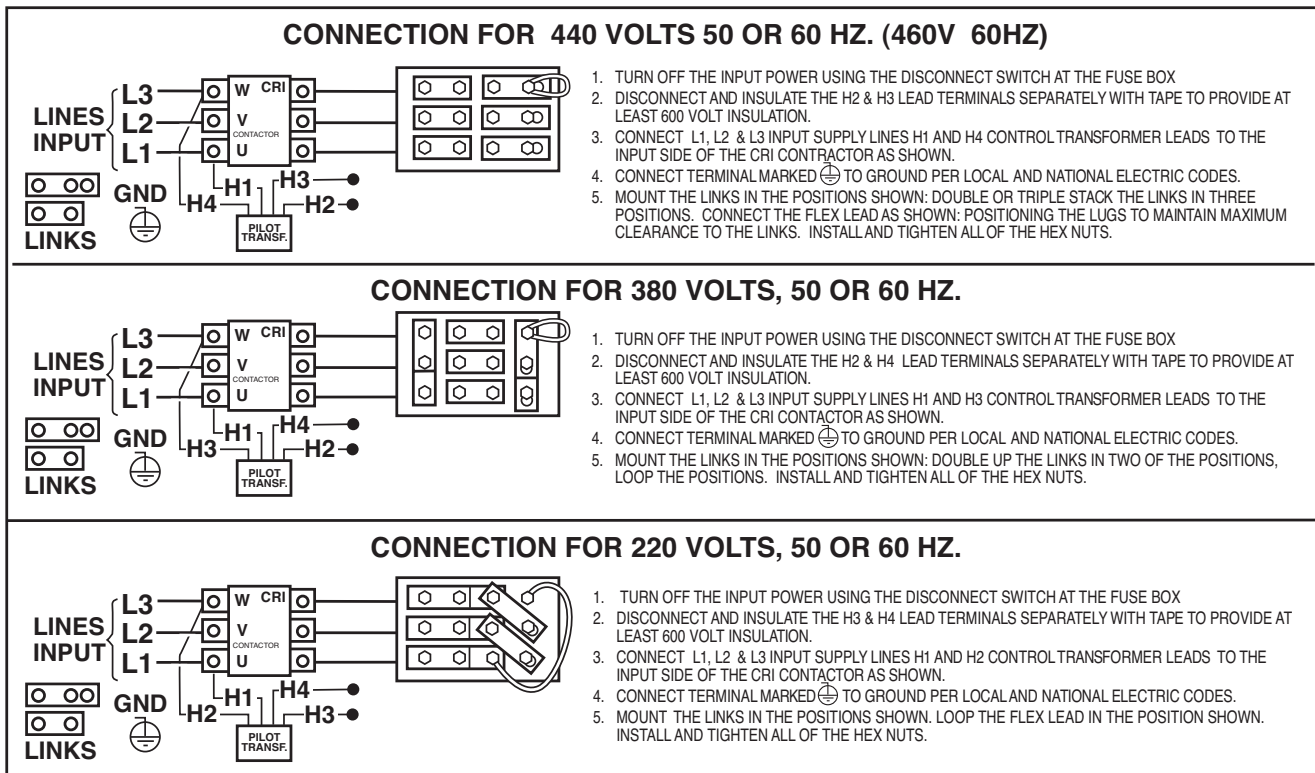

FIGURE A.5-Reconnect Panel Board Positions for 220/380/440 VAC Machines

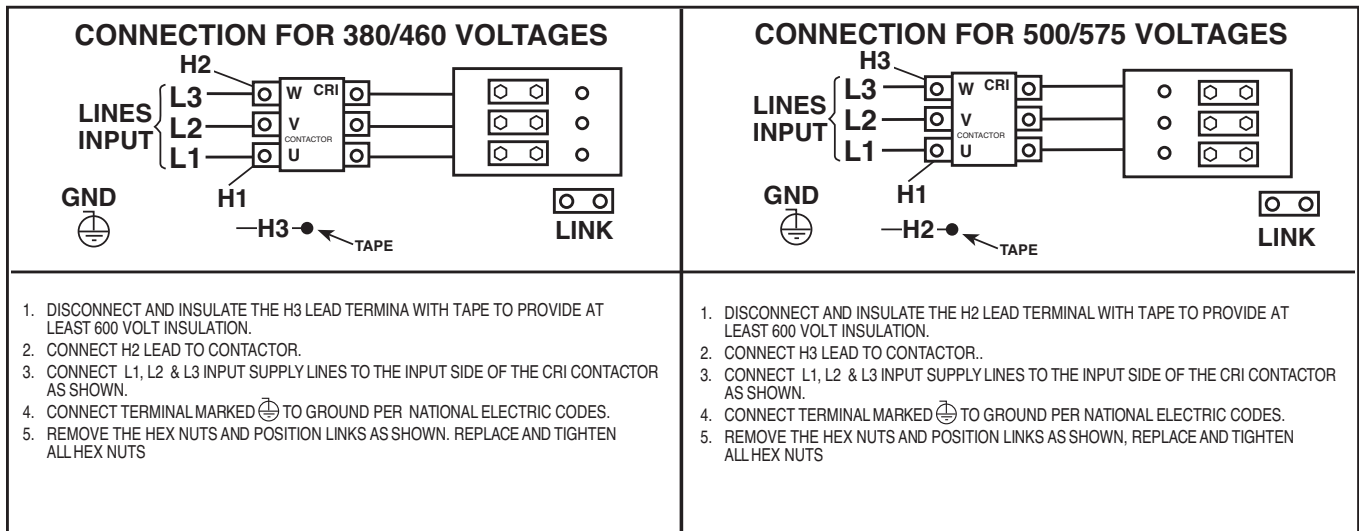

FIGURE A.6-Reconnect Panel Board Positions for 380/500, 460/575 VAC Machines

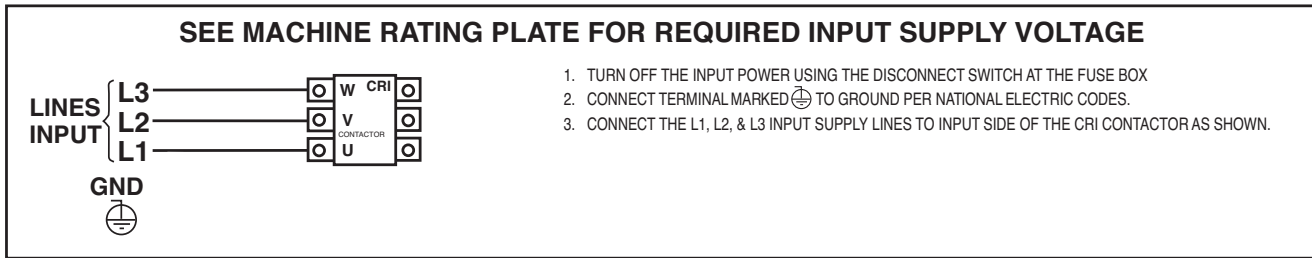

FIGURE A.7-Reconnect Panel Board Positions for Single Voltage Machines

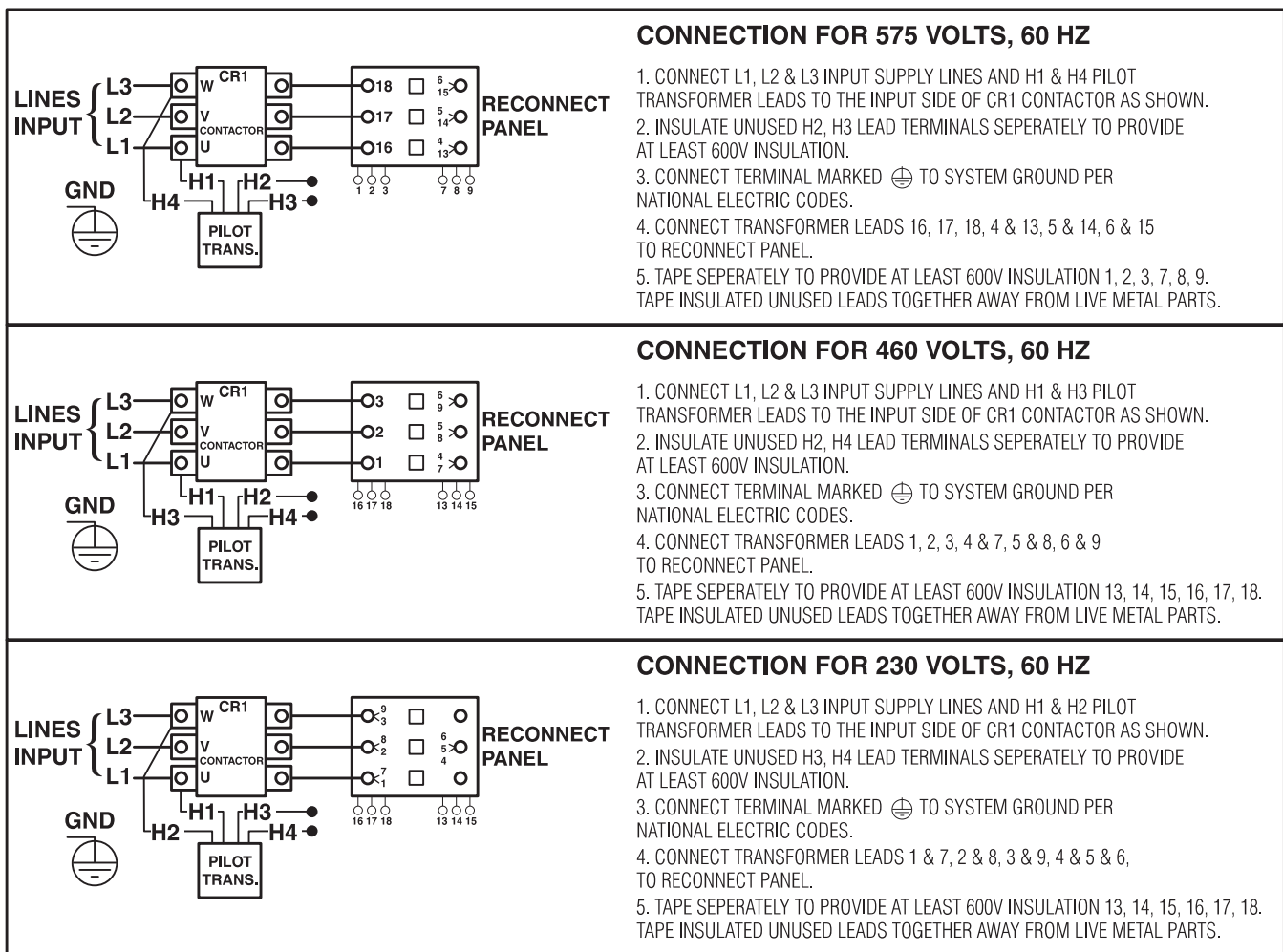

FIGURE A.8-Reconnect Panel Board Positions for 230/460/575 VAC Machines

OUTPUT CONNECTIONS

See Table A.1 for recommended IDEALARC® DC-600 cable sizes for combined lengths of electrode and work cables.

TABLE A.1
IDEALARC® DC-600 Cable Sizes for Combined Lengths of Copper Electrode and Work Cable at 100% Duty Cycle

Cable Length	Parallel Cables	Cable Size
Lengths up to 150 ft. (46m)	2	1/0 (53mm ²)
150 ft.(46m) to 200 ft (61m)	2	2/0 (67mm ²)
200 ft.(61m) to 250 ft.(76m)	2	3/0 (85mm ²)

ELECTRODE, WORK AND #21 LEAD CONNECTIONS

A. Connect Electrode and Work Leads to Output Terminals.

1. Set the ON/OFF toggle switch to OFF.
2. Locate the retractable strain relief loops directly below the output terminals in the lower right and lower left corners of the Case Front Assembly. See Figure A.9.
3. Pull out the retractable strain relief loops.
4. Insert the electrode lead through the loop directly below the desired polarity (positive or negative). Pull through enough cable to reach the output terminals.
5. Connect electrode lead to the desired terminal (positive/negative).
6. Tighten the output terminal nut with a wrench.
7. Connect the work lead to the other output terminal following steps 4-6.

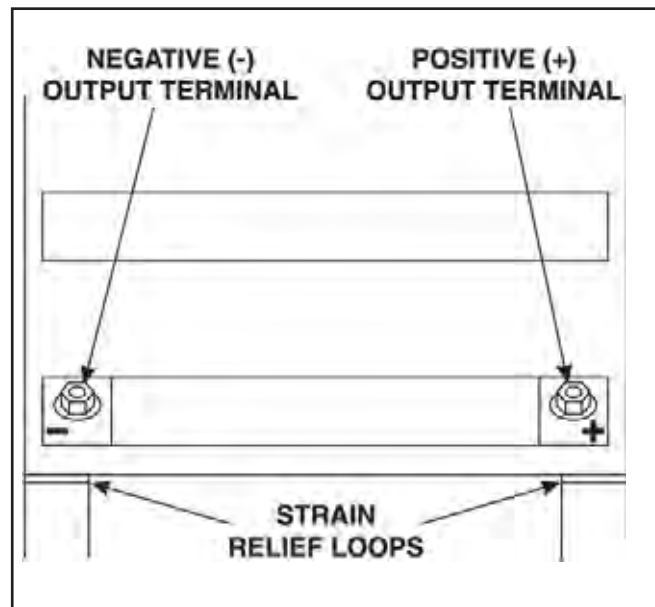

FIGURE A.9 - Output Terminals.

B. Connect #21 Work Sense Lead to Proper Terminal

There are two work sense lead connection points (+21 and -21) on terminal strip (T.S.2) located behind the hinged access panel on the right side of the case front. See 14 Pin MS Type Receptacle section or Terminal Strip Section for connection procedure.

AUXILIARY POWER AND CONTROL CONNECTIONS

Located at the left side of the front of the welder behind a hinged cover is a 115VAC duplex receptacle for auxiliary power (60 Hertz Models only). On the right side of the case front is a 14 Pin MS type receptacle for connection of auxiliary equipment such as wire feeders. Also, terminal strips with 115VAC and connections for auxiliary equipment are located behind the hinged access panel on the right side of the case front. (see Auxiliary Power Table for details)

AUXILIARY POWER TABLE

Voltage and Circuit Breaker Ratings at Auxiliary Power Connections for Various Models

Auxiliary Power Connections	60 Hz Models	50/60 Hz Models
At Duplex Receptacle	115V 15A	No Duplex
Terminal strip terminals 31 & 32	115V 15A	115V 15A
MS-Receptacle pins A & J	115V 15A	115V 15A
MS-Receptacle pins I & K	42V 10A	42V 10A

115VAC DUPLEX RECEPTACLE (60 HERTZ MODELS ONLY)

The 115VAC duplex receptacle is protected by a circuit breaker located on the nameplate. The receptacle is a NEMA 5-15R.

14 PIN MS TYPE RECEPTACLE

(For MS3106A-20-27PX Plug. L.E.C. Part #S12020-32)

Refer to the figure A.10 for the available circuits in the 14 pin receptacle.

42 VAC is available at receptacle pins I and K. A 10 amp circuit breaker protects this circuit.

115 VAC is available at receptacle pins A and J (All Models). A 15 amp circuit breaker protects this circuit. Note that the 42 VAC and 115 VAC circuits are electrically isolated from each other.

FIGURE A.10 FRONT VIEW OF 14-PIN CONNECTOR RECEPTACLE

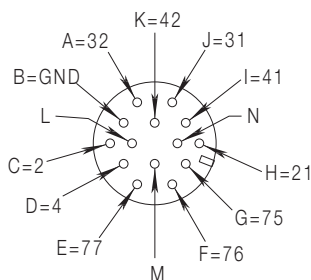

PIN	LEAD NO.	FUNCTION
A	32	115 VAC
B	GND	Chassis Connection
C	2	Trigger Circuit
D	4	Trigger Circuit
E	77	Output Control
F	76	Output Control
G	75	Output Control
H	21	Work Sense Connection ²
I	41	42 VAC
J	31	115 VAC ¹
K	42	42 VAC
L	---	---
M	---	---
N	---	---

TERMINAL STRIPS

Terminal strips are available behind the cover on the case front to connect wire feeder control cables that do not have a 14 Pin MS-type connector. These terminals supply the connections as shown in the following Terminal Strip charts. NOTE: There are two work sense lead connection points on the terminal strip. Connect both the work sense lead #21 from the 14 pin connector and #21 lead of the control cable to “-21” when welding positive polarity or to “+21” when welding negative polarity.

TERMINAL STRIP 1 (T.S.1)

Lead No.	Function
75	Output Control
76	Output Control
77	Output Control

TERMINAL STRIP 2 (T.S.2)

Lead No.	Function
+21	Work Connection (Electrode Negative)
-21	Work Connection (Electrode Positive) ²
41	42 VAC
4	Trigger Circuit
2	Trigger Circuit
31	115 VAC ¹
32	115 VAC ¹

¹ 115VAC circuit is on all models.

² As shipped from the factory Lead #21 from the 14 Pin connector is connected to “-21” on the terminal strip (T.S.2). This is the configuration for positive welding. If welding negative polarity, connect lead #21 to the “+21” connection point on the terminal strip (T.S.2).

SAFETY PRECAUTIONS

Read this entire section of operating instructions before operating the machine.



WARNING



ELECTRIC SHOCK can kill.

- Do not touch electrically live parts or electrodes with your skin or wet clothing.
- Insulate yourself from the work and ground.
- Always wear dry insulating gloves.
- Do not use AC welder if your clothing, gloves or work area is damp or if working on, under or inside work-piece.



Use the following equipment:

- Semiautomatic DC constant voltage (wire) welder.
- DC manual (stick) welder.
- AC welder with reduced voltage control.
- Do not operate with panels removed.
- Disconnect input power before servicing.

READ THIS WARNING, PROTECT YOURSELF & OTHERS.



FUMES AND GASES can be dangerous.

- Keep your head out of fumes.
- Use ventilation or exhaust at the arc, or both, to keep fumes and gases from your breathing zone and general area.



WELDING, CUTTING and GOUGING SPARKS can cause fire or explosion.

- Do not weld near flammable material.
- Do not weld, cut or gouge on containers which have held flammable material.



ARC RAYS can burn.

- Wear eye, ear, and body protection.

Observe additional Safety Guidelines detailed in the beginning of this manual.

IDEALARC® DC-600



GENERAL DESCRIPTION

The IDEALARC® DC-600 is an SCR controlled three phase welding and cutting power source. It uses a single range potentiometer to control:

- Submerged Arc Semi-Automatic or Automatic Welding
- Open Arc Semi-Automatic or Automatic Welding
- Stick Welding
- Air/Carbon Arc Cutting (Carbon Rod Sizes up to 3/8" Diameter)

The IDEALARC® DC-600 has a three-position Welding Mode Switch to enable the user to operate in one of three modes:

- Constant Current (CC) Stick (also used for AAC)
- Constant Voltage (CV) Submerged Arc
- Constant Voltage (CV) Innershield (also used for FCAW/GMAW)

Three models are available:

- Domestic - all 60 Hertz models except 230/460/575V.
- Canadian-230/460/575V 60 Hertz models
- Export-50/60 Hertz models

The optional Multi-Process Switch allows the user to switch between semi-automatic or automatic welding and stick welding or air/carbon arc cutting without disconnecting the wire feeder equipment control, electrode, and work leads.

RECOMMENDED PROCESSES AND EQUIPMENT

The IDEALARC® DC-600 is designed for GMAW (MIG), FCAW, and submerged arc (SAW) within the capacity of the machine. It can also be used for stick welding (SMAW) and for air carbon arc (AAC) cutting with carbon rods up to 3/8" diameter.

The IDEALARC® DC-600 is provided with a three position mode switch that selects CV Innershield, CV Submerged Arc, or CC Stick.

The IDEALARC® DC-600 can be easily connected to wire feeding equipment, including:

- Semi-automatic wire feeders LN-7, LN-7 GMA, LN-742, LN-8, LN-9, LN-9 GMA, LN- 10, LN-15 LN-23P, LN-25, and DH-10.
- Automatic wire feeders NA-3, NA-5, and NA-5R.
- Tractors LT-56 and LT-7

DESIGN FEATURES AND ADVANTAGES

- Excellent arc characteristics for optimum constant voltage submerged arc and Innershield welding performance.
- A control circuit designed to provide good starting for a large variety of processes and procedures.
- Output Control Potentiometer that provides easy single range continuous control.
- Output Control Switch that provides simple switching from local to remote control.
- Output Terminals Switch to energize output terminals either local or remote.
- White neon pilot light to confirm that the Input Contactor is energized.
- DC Ammeter and Voltmeter
- 42VAC 10 Amp auxiliary power available for the wire feeder, circuit breaker protected.
- Single MS-type (14 pin) connector for wire feeder.
- 115VAC 15 Amp auxiliary power available for the wire feeder, circuit breaker protected.
- 115VAC 15 Amp duplex plug receptacle available on 60 Hertz models, circuit breaker protected.
- Multi-functional terminal strip for easy connection of wire feeding control cables.
- Recessed output terminals to avoid any person or object from accidentally coming into contact with the output terminals and labeled " + " and " - " for easy identification.
- Thermostatically protected power source.
- Electronic protection circuit to protect power source against overloads.
- Input line voltage compensation to provide an essentially constant output.
- SCR electronically controlled welder output provides extra long life, especially for highly repetitive welding applications.
- Solid state 2 and 4 circuit for extra long life.
- Two circuit solid state control system provides maximum performance and circuit protection.
- Low profile case provides maximum use of space.
- Convenient access to all controls.
- Output lead strain relief loops to prevent terminal and cable damage.
- Easily removed case side, even when stacked.
- Outdoor operation because enclosure is designed with air intake louvers that keep dripping water from entering the unit. Transformer, SCR bridge, and choke have special corrosion resistant paint for added protection.

IDEALARC® DC-600



WELDING CAPABILITY

The IDEALARC® DC-600 has the following Output and Duty Cycle based on operation for a 10 minute period:

- 600 Amps, 44 Volts at 100%
- 680 Amps, 44 Volts at 60%
- 750 Amps, 44 Volts at 50%

MEANINGS OF GRAPHICAL SYMBOLS ON CASE FRONT

Input POWER ON/OFF Switch

SYMBOL

MEANING



ON



OFF



INPUT POWER

Pilot Light



Input power on when light is illuminated (except for abnormal conditions). Always indicates POWER ON/OFF switch is in ON position.

OUTPUT CONTROL



OUTPUT VOLTAGE AND CURRENT



Clockwise Increase of Output Voltage and Current

TERMINALS ON/REMOTE Switch



OUTPUT TERMINALS ENERGIZED



Remote Control of Output Terminals (Energized or Non-Energized)

LOCAL/REMOTE Switch

SYMBOL

MEANING



Control Of Output Voltage and Current is Via IDEALARC® DC-600's Control Dial



Remote Control of Output Voltage and Current

MODE Switch



CC STICK: Shielded Metal Arc Welding (SMAW), this switch position is also used for Air Carbon Arc Cutting (AAC)



CV SUBMERGED ARC: Constant Voltage Submerged Arc Welding (SAW)



CV INNERSHIELD: Flux Cored Arc Welding (FCAW), this switch position is also used for Gas Metal Arc Welding (GMAW).

Output Terminal Connections



Positive Output Terminal



Negative Output Terminal

WARNING Identification



Warning Identification

Circuit Breaker





Circuit Breaker (two breakers: 15A for 115V circuit and 10A for 42V circuit)

MEANING OF GRAPHICAL SYMBOLS ON RATING PLATE (LOCATED ON CASE BACK)

Designates welder complies with National Electrical Manufacturers Association requirements EW 1 Class I with 100% duty cycle at 600Amps output.

NEMA EW 1 (100%)  Three Phase Input Power

 3 Phase transformer with rectified DC output

 Line Connection

 Gas Metal Arc Welding (GMAW)

 Flux Cored Arc Welding (FCAW)

 Shielded Metal Arc Welding (SMAW)

 Submerged Arc Welding (SAW)

 Designates welder complies with both Underwriters Laboratories (UL) standards and Canadian Standards Association (CSA) standards. (60 Hertz Models)

MEANING OF GRAPHICAL SYMBOL FOR GROUND CONNECTION

 Signifies the equipment connection point for the protective earth ground

CONTROLS AND SETTINGS

All operator controls and adjustments are located on the Case Front Assembly of the IDEALARC® DC-600. See Figure B.1 for the location of each control.

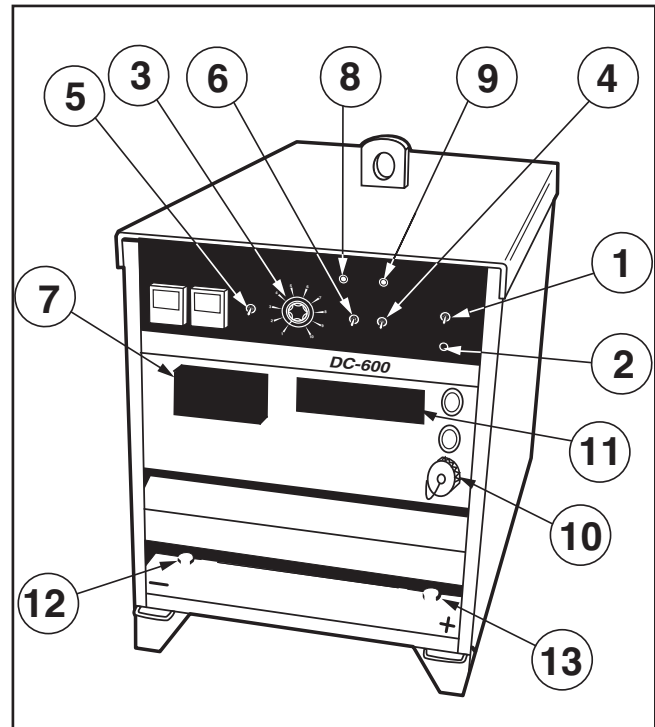



FIGURE B.1 - CONTROL PANEL KEYS

- 1. Input POWER ON/OFF Switch** 



This toggle switch turns the machine on or off. Putting the switch in the ON “ I ” position energizes the machine’s input contactor applying input power to the machine. Switching the switch to the OFF “ O ” position de-energizes the input contactor.
- 2. POWER Light** 

When the POWER switch is in the ON position the machine’s white POWER light will illuminate. If the input contactor de-energizes the machine in an abnormal situation the pilot light will still illuminate. In this situation it may be necessary to reset the machine by switching the POWER switch to the OFF and then to the ON position. (See Overload, Overcurrent, and Fault Protection Section)



3. OUTPUT CONTROL

This control provides continuous control of the machine's output voltage and current from minimum to maximum (typical full pot range between 15 to 44 volts and 90 to 750 amps) as it is rotated clock-wise. Voltage or current control is determined by setting of Mode Switch (CV or CC).

4. OUTPUT TERMINALS ON/REMOTE Switch

When this switch is in the REMOTE "  " position, the IDEALARC® DC-600's output terminals will be electrically "cold" until a remote device such as a wire feeder closes the #2 and #4 circuit in the MS-receptacle or terminal strip (T.S.2). When this switch is in the ON "  " position the machine's output terminals will be electrically energized all the time.

5. LOCAL/REMOTE Switch

When this switch is set to the LOCAL "  " position, control of the output voltage and current is via the OUTPUT CONTROL on the IDEALARC® DC-600's control panel. When this switch is set to the REMOTE "  " position, control is through a remote source such as a wire feeder via the #75, #76, and #77 leads in the MS-receptacle or terminal strip (T.S.1).

6. Mode Switch

This switch allows for selecting the welding process to be used:

CC STICK-for SMAW and AAC

CV SUBMERGED ARC- for SAW

CV INNERSHIELD- for FCAW and GMAW

7. 115VAC Duplex Receptacle (60 Hertz Models)

This receptacle provides up to 15 amps of 115 VAC auxiliary power.



8. 115VAC 15 Amp Circuit Breaker

This breaker protects the 115 VAC auxiliary circuits located in the duplex receptacle, terminal strip (T.S.2) and MS-receptacle.



9. 42VAC 10 Amp Circuit Breaker

This breaker protects the 42VAC auxiliary circuits located in the terminal strip (T.S.2) and MS-receptacle.

10. 14 Pin MS-Receptacle

This connector provides easy connection for a wire feeder control cable. It provides connections for auxiliary power, output switching, remote output control, wire feeder voltmeter sense lead and ground. Refer to 14 Pin MS Type Receptacle in the Installation Section for information about the circuits made available at this receptacle.

11. Terminal Strip Cover Panel

Rotate this panel to gain access to the circuits made available at the two terminal strips (T.S.1 and T.S.2). These terminal strips contains the same circuits as the 14 pin MS-receptacle. There is a box connector adjacent to this cover for routing leads to the terminal strips.



12. Negative Output Terminal

This output terminal is for connecting a welding cable. To change welding polarity and for proper welding cable size refer to Electrode and Work Cables in the Installation Section.



13. Positive Output Terminal

This output terminal is for connecting a welding cable. To change welding polarity and for proper welding cable size refer to Electrode and Work Cables in the Installation Section.

AUXILIARY POWER IN MS-RECEPTACLE

42 volt AC auxiliary power, as required for some wire feeders, is available through the wire feeder MS-receptacle. A 10 amp circuit breaker protects the 42 volt circuit from overloads.

IDEALARC® DC-600 machines can also supply 115 volt AC auxiliary power through the wire feeder receptacle. A 15 amp circuit breaker protects the 115 volt circuit from overloads.

OVERLOAD, OVERCURRENT, AND FAULT PROTECTION

This welder has thermostatic protection from excessive duty cycles, overloads, loss of cooling, and high ambient temperatures. When the welder is subjected to an overload or loss of cooling, a thermostat will open. The input contactor will open and remain open until the machine cools; the white POWER light stays illuminated. No welding is possible during this cool down period. The machine will reset automatically when the thermostat cools.

The power source is also protected against overcurrents in the SCR bridge assembly through an electronic protection circuit. This circuit senses currents over 780 amps on the power source and opens the input contactor should the overcurrent remain for a predetermined time (the white POWER light stays illuminated). The predetermined time varies with the amount of overcurrent; the greater the overcurrent, the shorter the time. The input contactor will remain open until the power source is manually started by resetting the POWER ON/OFF toggle switch.

The power source circuitry is protected from faults on leads 75, 76, or 77. If any of these leads are connected to either the positive or negative output leads, the IDEALARC® DC-600 will either shut down completely (input contactor opens and white POWER light stays illuminated), or will operate at minimum output thus preventing any damage to the IDEALARC® DC-600. If IDEALARC® DC-600 shuts down, it must be manually started by resetting the POWER ON/OFF toggle switch.

OPERATING STEPS

The following procedures are for using the IDEALARC® DC-600 in the local control mode of operation. For remote control of the machine, see the Remote Control of Machine Operation section.

Before operating the machine, make sure you have all materials needed to complete the job. Be sure you are familiar with and have taken all possible safety precautions before starting work. It is important that you follow these operating steps each time you use the machine.

1. Turn on the main AC power supply to the machine.
2. Connect the #21 work lead to either + or - on terminal strip (T.S.2).
3. Set the Welding Mode switch to welding process being used:
 - CC STICK (for SMAW and AAC)
 - CV SUBMERGED ARC (for SAW)
 - CV INNERSHIELD (for FCAW and GMAW)
4. Turn the POWER ON/OFF Toggle Switch to the "ON" position
 - The white pilot light glows.
 - The fan starts.
5. Set OUTPUT CONTROL Potentiometer to desired voltage or current.
6. Set the OUTPUT TERMINALS switch to either "ON" (output terminals energized) or "REMOTE" (output terminals energized when #2 and #4 closed by remote device such as wire feeder)
7. Make the weld.

REMOTE CONTROL OF MACHINE OPERATION

The toggle switch on the control panel labeled "Remote - Panel" gives the operator the option of controlling the machine output from a remote location. If in the Remote position a wire feeder with remote control capabilities or a remote control device such as a K775 must be connected to terminals 75, 76, and 77. Refer to Accessories Section for wire feeder remote information.

WELDING PROCEDURE RECOMMENDATIONS

Select Welding Mode Switch position based on type of welding to be done.

1. Innershield Welding (FCAW)/MIG (GMAW) Welding: Use the **CV INNERSHIELD** mode.
2. Submerged Arc Welding (SAW): Use the **CV SUBMERGED ARC** mode. If performing high speed welding, switch between the CV Submerged Arc and the CV Innershield mode and use the mode that produces the best welding results.
3. Air/Carbon Arc Cutting (AAC) / Stick Welding (SMAW) / High Current, Large Puddle Submerged Arc Welding (SAW): Use the **CC STICK** mode. When the IDEALARC® DC-600 is used for Air/Carbon Arc cutting, the OUTPUT CONTROL potentiometer should be set to "9" initially. Based on the size of the carbon being used or the process, turn the potentiometer to a lower setting as required by the process. You can use carbon rods up to 3/8" in diameter at currents as high as 750 amps with excellent arc control. The welder protection circuit protects the machine from extremely high short circuiting pulses.

SEMI-AUTOMATIC AND AUTOMATIC WIRE FEEDING WITH THE IDEALARC® DC-600 AND WIRE FEEDERS

When using the IDEALARC® DC-600 with semi-automatic or automatic wire feeding equipment and for stick welding or air/carbon arc cutting, it is recommended that the optional MULTI-PROCESS SWITCH be used. This switch permits you to easily change the polarity of the connected wire feeding equipment or switch to stick welding or air/carbon arc cutting.

NA-3 AUTOMATIC WIRE FEEDER

1. Set the IDEALARC® DC-600 LOCAL/REMOTE Switch to REMOTE. Set the OUTPUT TERMINALS switch to REMOTE. NOTE: Later model NA-3 automatic wire feeders are capable of cold starts when the NA-3 Mode switch is in the CV or CC mode position. Some earlier models are capable of cold starting only in the CC mode position. Cold starting enables you to inch the wire down to the work, automatically stop, and automatically energize the flux hopper valve.
2. Set the IDEALARC® DC-600 welding mode switch for the desired process: CV SUBMERGED ARC, CV INNERSHIELD mode or CC STICK mode.
3. Set the NA-3 mode Switch Position to either CV or CC to match the IDEALARC® DC-600 mode selected in step 2.
4. Refer to the NA-3 operators manual for instructions on how to use the NA-3 in conjunction with the IDEALARC® DC-600.
5. Follow the following guidelines for good arc striking detailed below for each welding mode.

GOOD ARC STRIKING GUIDELINES FOR THE NA-3 WITH THE IDEALARC® DC-600 IN THE CV INNERSHIELD, CV SUBMERGED ARC OR CC STICK WELDING MODES.

Following are some basic arc striking techniques that apply to all wire feed processes. Using these procedures should provide trouble-free starting. These procedures apply to single, solid wires and Innershield wires.

1. Cut the electrode to a sharp point.
2. Set the NA-3 Open Circuit Voltage Control to the same dial setting as the Arc Voltage Control. If this is a new welding procedure, a good starting point is to set the Open Circuit Voltage Control to # 6.

NOTE: The open circuit voltage of the IDEALARC® DC-600 varies from approximately 16 volts to 56 volts in the CV INNERSHIELD or CV SUBMERGED ARC modes. The open circuit voltage is constant in the CC STICK mode.

3. Run a test weld. Set proper current, voltage, and travel speed.
 - For the best starting performance, the NA-3 Open Circuit Voltage Control and Voltage Control setting should be the same. Set the Inch Speed Control for the slowest inch speed possible.

- To adjust the Open Circuit Voltage Control to get the best starting performance, make repeated starts observing the NA-3 voltmeter.

When the voltmeter pointer swings smoothly up to the desired arc voltage, without undershooting or overshooting the desired arc voltage, the Open Circuit Voltage Control is set properly.

If the voltmeter pointer overshoots the desired voltage and then returns back to the desired voltage, the Open Circuit Voltage Control is set too high. This can result in a bad start where the wire tends to "Blast off."

If the voltmeter pointer hesitates before coming up to the desired voltage, the Open Circuit Voltage Control is set too low. This can cause the electrode to stub.

4. Start and make the weld.
 - Cold starts. For cold starts, be sure the work piece is clean and the electrode makes positive contact with the work piece.
 - Hot "On the Fly" starts. For hot starts, travel should begin before the wire contacts the work piece.

ARC STRIKING WITH IDEALARC® DC-600 AND THE NA-3 START BOARD

When electrical strikeouts exceed 1 3/4" (44.4mm) an NA-3 Start Board may be required to improve arc striking.

When the NA-3 Start Board is used to improve arc striking, use the following procedures:

1. Set start time at 0.
2. Set NA-3 start current and start voltage at mid-range.
3. Set the NA-3 output current and voltage to the proper settings for the welding procedure to be used.
4. Turn the Start Board Timer to maximum.
5. Set Start Board current and voltage control.
 - Set the Start Board current control to 1 1/2 dial numbers below that set on the NA-3 current control.
 - Set the Start Board voltage control equal with the NA-3 voltage control setting.

NOTE: These Start Board current and voltage settings result in a start up current that is lower than the NA-3 current setting and approximately equal with the NA-3 voltage setting for the desired welding procedure.

6. Establish the correct arc striking procedure with the NA-3 Start Board timer set at maximum.
 - For the best starting performance, the NA-3 Open Circuit Voltage Control and Voltage Control setting should be the same. Set the Inch Speed Control for the slowest inch speed possible.
 - To adjust the Open Circuit Voltage Control to get the best starting performance, make repeated starts observing the NA-3 voltmeter.

When the voltmeter pointer swings smoothly up to the desired arc voltage, without undershooting or overshooting the desired arc voltage, the Open Circuit Voltage Control is set properly.

If the voltmeter pointer overshoots the desired voltage and then returns back to the desired voltage, the Open Circuit Voltage Control is set too high. This can result in a bad start where the wire tends to "Blast off."

If the voltmeter pointer hesitates before coming up to the desired voltage, the Open Circuit Voltage Control is set too low. This can cause the electrode to stub.

- Set NA-3 Start Board current and voltage as close to the welding procedure current and voltage as possible.

NOTE: The Start Board current and voltage should be as close as possible to the welding procedure current and voltage, while still getting satisfactory starts.

- Set the start time to as low a time as possible while still getting satisfactory starts.

7. Start and make the weld.

IDEALARC® DC-600 POWER SOURCE SETTING WHEN CONNECTED TO NA-5 WIRE FEEDER

When using the IDEALARC® DC-600 with the NA-5 wire feeder, set the controls on the IDEALARC® DC-600 as follows for the best performance:

1. Turn OFF main AC input power supply to the IDEALARC® DC-600.
2. Connect the electrode cables to terminal polarity to be used.
3. Connect the #21 work lead (on T.S.2) to the same polarity as the work cable connection.
4. Set the IDEALARC® DC-600 LOCAL/REMOTE Switch to REMOTE.
5. Set the IDEALARC® DC-600 OUTPUT TERMINALS switch to REMOTE.
6. Set the IDEALARC® DC-600 WELDING MODE SWITCH to the position that matches the welding process being used.
 - For submerged arc welding, set WELDING MODE SWITCH to CV SUBMERGED ARC position.
 - For all open arc welding processes set WELDING MODE SWITCH to CV INNERSHIELD position.

WIRE FEEDERS AND TRACTORS

The IDEALARC® DC-600 can be used to power any of the following Lincoln Wire Feeders and Tractors:

Semi-Automatic Wire Feeders:

DH-10	LN-9
LN-7	LN-9 GMA
LN-7 GMA	LN-23P
LN-742	LN-25
LN-8	LN-10

Automatic Wire Feeders:

NA-3	NA-5R
NA-5	

Tractors:

LT-7	LT-56
------	-------

FIELD INSTALLED OPTIONS

Remote Output Control (K775 or K857 with K864 Adapter)

An optional "remote out control" is available. The K775 is the same remote control that is used on other Lincoln power sources. The K775 consist of a control box with 28 feet (8.5mm) of four conductor cable. This connects to terminals 75,76, and 77 on the terminal strip (T.S.1) and the case grounding screw so marked with the symbol "⊕" on the machine. These terminals are located behind the hinged cover on the case front. This control will give the same control as the output control on the machine.

The K857 is similar to the K775, except the K857 has a 6-pin MS-style connector. The K857 requires a K864 adapter cable which connects to the 14-pin connector on the case front.

Remote Control Adapter Cable (K864)

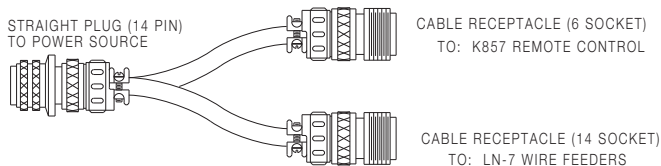

A "V" cable 12" (.30 m) long to connect a K857 Remote Control (6-pin connector) with an LN-7 wire-feeder (14-pin connector) and the machine (14-pin connector). If a remote control is used alone the wire-feeder connection is then not used.

Undercarriages (K817P, K842)

For easy moving of the machine, optional undercarriages are available with polyolefin wheels (K817P) or a platform undercarriage (K842) with mountings for two gas cylinders at rear of welder.

Paralleling Kit (K1611-1)

Permits paralleling of two IDEALARC® DC-600's for welding currents of up to 1200 amps, 100% duty cycle.

Tig Module (K930-2)

Portable high frequency generator for AC/DC TIG welding.

FACTORY OR FIELD INSTALLED OPTIONS

Multi-Process Switch (K804-1)

The MULTI-PROCESS SWITCH gives you the ability to:

- Switch between "stick welding or air/carbon arc cutting" and using a semi-automatic or automatic wire feeder.
- Change the polarity of a semi-automatic or automatic wire feeder without changing any electrical cable connections.

See Figure C.1

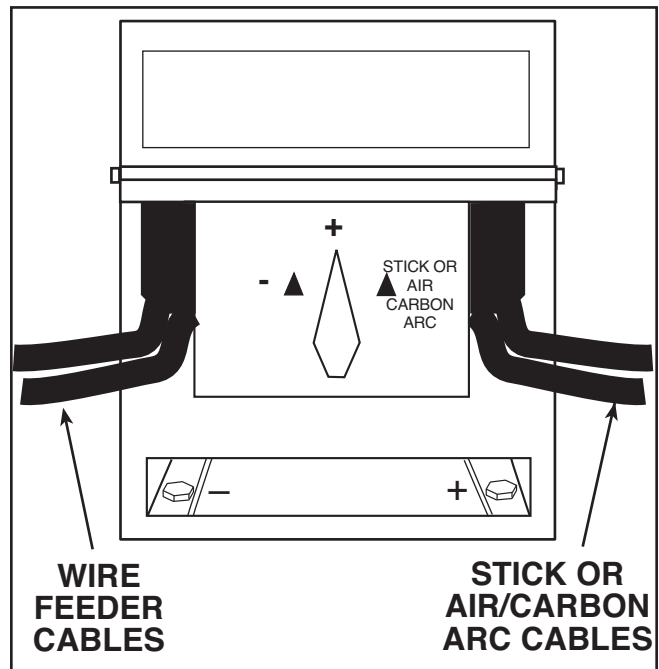

FIGURE C.1 - MULTI-PROCESS SWITCH

The MULTI-PROCESS SWITCH has two sets of output terminals. You connect the wire feeder unit cables to the set of terminals on the left side of the box and the stick or air/carbon arc cables to the set of terminals on the right side (facing the front of the machine) as shown in Figure C.1. The output terminals are protected against accidental contact by hinged covers.

When the MULTI-PROCESS SWITCH is in the "Stick or Air/Carbon Arc" position, only those terminals are energized. The wire feeder nozzle or gun and electrode are not electrically "hot" when in this mode.

Follow these steps to install the MULTI-PROCESS SWITCH:

1. Confirm that the IDEALARC® DC-600 POWER ON/OFF switch is in the OFF position.
2. Disconnect main AC input power to the IDEALARC® DC-600.
3. Open the terminal strip hinged cover located on the Case Front Assembly.
4. The MULTI-PROCESS SWITCH is mounted to the case front with four 1/4" self-tapping screws. The screw holes are 13.8" apart side to side and 4.5" apart top to bottom. Run one of the 1/4" screws part way in and out of the screw holes to open them up. Make sure that the two sleeved control leads do not get pinched when hanging the switch; route them out the side to the right of the switch. Support the switch in position and start the four screws, then tighten them.
5. Route the MULTI-PROCESS SWITCH control leads through the strain-relief box connectors and into the terminal strip. Connect wire feeder control cable as specified in specific connection diagram and make other terminal strip connections as specified on the connection diagram for the Lincoln wire feeder being used.
6. Connect the control leads from the MULTI-PROCESS SWITCH to terminals #2 and #4 on the IDEALARC® DC-600's terminal strip.
7. Connect the right cable from the MULTI-PROCESS SWITCH (facing the front of the machine) to the IDEALARC® DC-600 positive (+) output terminal. See Figure C.2.
8. Connect the left cable from the MULTI-PROCESS SWITCH (facing the front of the machine) to the IDEALARC® DC-600 negative (-) output terminal. See Figure C.2.
9. Connect the wire feeder electrode and work cables. See Figure C.2.
 - Insert the wire feeder electrode and work cables through the strain relief loop on the left side of the IDEALARC® DC-600 (facing the front of the machine).
 - Connect the wire feeder electrode and work cables to the electrode and work terminals on the left side of the MULTI-PROCESS SWITCH.
10. Connect wire feeder control cable and make other terminal strip connections as specified on the connection diagram for the Lincoln wire feeder being used.
11. Set the IDEALARC® DC-600 OUTPUT TERMINALS switch to REMOTE.

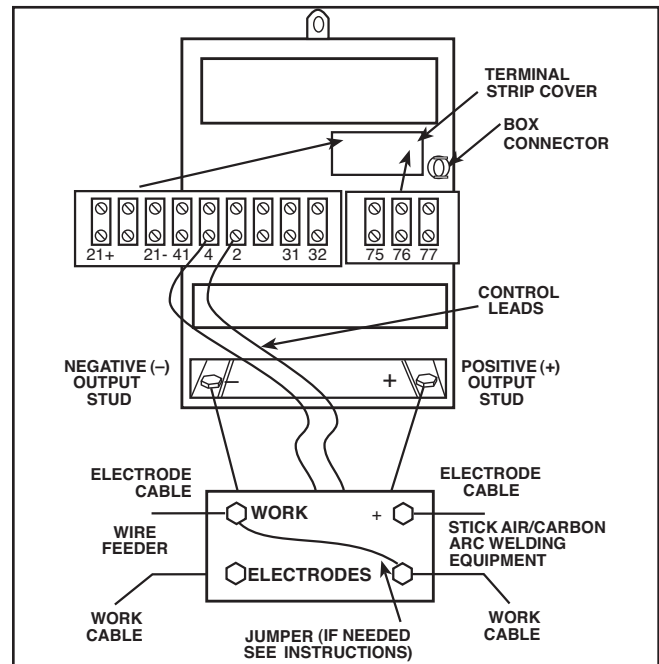

FIGURE C.2 - MULTI-PROCESS SWITCH CABLE CONNECTIONS.

12. Connect stick or air/carbon arc electrode and work cable. See Figure C.2.

- Insert the electrode and work cables through the strain relief loop on the right side (facing the front of the machine) of the IDEALARC® DC-600.
- Connect the electrode cable to the "Positive" terminal on the right side of the MULTI-PROCESS SWITCH.
- Connect the work cable to the "Negative" terminal on the right side of the MULTI-PROCESS SWITCH.

NOTE: The instructions above are for connecting the stick polarity positive. To change the polarity, turn the IDEALARC® DC-600 OFF, and reverse the cables.

NOTE: When it is not necessary to have separate ground cables for stick and semi-automatic or automatic welding, connect a jumper from the MULTI-PROCESS SWITCH "Work" terminal to the MULTI-PROCESS SWITCH "negative" terminal. See Figure C.2.

To operate the MULTI-PROCESS SWITCH, refer to the operating instructions on the switch nameplate.

CONNECTIONS FOR SEMI-AUTOMATIC OR AUTOMATIC WIRE FEEDER CONTROL

1. Set the IDEALARC® DC-600 ON/OFF switch to OFF.
2. Set the IDEALARC® DC-600 LOCAL/REMOTE switch to REMOTE.
3. Set the IDEALARC® DC-600 OUTPUT TERMINALS switch to REMOTE.
4. Set the IDEALARC® DC-600 MODE switch to the welding process being used.
5. Refer to the proper connection diagram in the DIAGRAMS section for more information.

SAFETY PRECAUTIONS**⚠ WARNING****ELECTRIC SHOCK CAN KILL.**

Only qualified personnel should perform this maintenance.

Turn the input power **OFF** at the disconnect switch or fuse box before working on this equipment.

Do not touch electrically hot parts.

ROUTINE AND PERIODIC MAINTENANCE

1. Disconnect input AC power supply lines to the machine before performing periodic maintenance, tightening, cleaning, or replacing parts.

Perform the following daily:

1. Check that no combustible materials are in the welding or cutting area or around the machine.
2. Remove any debris, dust, dirt, or materials that could block the air flow to the machine for cooling.
3. Inspect the electrode cables for any slits or punctures in the cable jacket, or any condition that would affect the proper operation of the machine.

Perform Periodically:

Clean the inside of the machine with low pressure air stream. Clean the following parts.

- Main transformer and choke.
- Electrode and work cable connections.
- SCR rectifier bridge and heat sink fins.
- Control board.
- Firing board.
- Fan Assembly.

NOTE: The fan motor has sealed bearings which require no maintenance.

HOW TO USE TROUBLESHOOTING GUIDE

WARNING

Service and Repair should only be performed by Lincoln Electric Factory Trained Personnel. Unauthorized repairs performed on this equipment may result in danger to the technician and machine operator and will invalidate your factory warranty. For your safety and to avoid Electrical Shock, please observe all safety notes and precautions detailed throughout this manual.

This Troubleshooting Guide is provided to help you locate and repair possible machine malfunctions. Simply follow the three-step procedure listed below.

Step 1. LOCATE PROBLEM (SYMPTOM).

Look under the column labeled "PROBLEM (SYMPTOMS)". This column describes possible symptoms that the machine may exhibit. Find the listing that best describes the symptom that the machine is exhibiting.

Step 2. POSSIBLE CAUSE.

The second column labeled "POSSIBLE CAUSE" lists the obvious external possibilities that may contribute to the machine symptom.

Step 3. RECOMMENDED COURSE OF ACTION

This column provides a course of action for the Possible Cause, generally it states to contact your local Lincoln Authorized Field Service Facility.

If you do not understand or are unable to perform the Recommended Course of Action safely, contact your local Lincoln Authorized Field Service Facility.

CAUTION

If for any reason you do not understand the test procedures or are unable to perform the tests/repairs safely, contact your **Local Lincoln Authorized Field Service Facility** for technical troubleshooting assistance before you proceed.

PC BOARD TROUBLESHOOTING PROCEDURES

⚠ WARNING



ELECTRIC SHOCK can kill. Have an electrician install and service this equipment. Turn the input power OFF at the fuse box before working on equipment. Do not touch electrically hot parts.

CAUTION: Sometimes machine failures appear to be due to PC board failures. These problems can sometimes be traced to poor electrical connections. To avoid problems when troubleshooting and replacing PC boards, please use the following procedure:

1. Determine to the best of your technical ability that the PC board is the most likely component causing the failure symptom.
2. Check for loose connections at the PC board to assure that the PC board is properly connected.
3. If the problem persists, replace the suspect PC board using standard practices to avoid static electrical damage and electrical shock. Read the warning inside the static resistant bag and perform the following procedures:

P.C. Board can be damaged by static electricity.



- Remove your body's static charge before opening the static-shielding bag. Wear an anti-static wrist strap. For safety, use a 1 Meg ohm resistive cord connected to a grounded part of the equipment frame.

- If you don't have a wrist strap, touch an unpainted, grounded, part of the equipment frame. Keep touching the frame to prevent static build-up. Be sure not to touch any electrically live parts at the same time.

- Tools which come in contact with the P.C. Board must be either conductive, anti-static or static-dissipative.
- Remove the P.C. Board from the static-shielding bag and place it directly into the equipment. Don't set the P.C. Board on or near paper, plastic or cloth which could have a static charge. If the P.C. Board can't be installed immediately, put it back in the static-shielding bag.

- If the P.C. Board uses protective shorting jumpers, don't remove them until installation is complete.
- If you return a P.C. Board to The Lincoln Electric Company for credit, it must be in the static-shielding bag. This will prevent further damage and allow proper failure analysis.

4. Test the machine to determine if the failure symptom has been corrected by the replacement PC board.

NOTE: It is desirable to have a spare (known good) PC board available for PC board troubleshooting.

NOTE: Allow the machine to heat up so that all electrical components can reach their operating temperature.

5. Remove the replacement PC board and substitute it with the original PC board to recreate the original problem.

- If the original problem does not reappear by substituting the original board, then the PC board was not the problem. Continue to look for bad connections in the control wiring harness, junction blocks, and terminal strips.

- If the original problem is recreated by the substitution of the original board, then the PC board was the problem. Reinstall the replacement PC board and test the machine.

6. Always indicate that this procedure was followed when warranty reports are to be submitted.

NOTE: Following this procedure and writing on the warranty report, "INSTALLED AND SWITCHED PC BOARDS TO VERIFY PROBLEM," will help avoid denial of legitimate PC board warranty claims.

Observe all Safety Guidelines detailed throughout this manual

PROBLEMS (SYMPTOMS)	POSSIBLE CAUSE	RECOMMENDED COURSE OF ACTION
OUTPUT PROBLEMS		
Major Physical or Electrical Damage is Evident	Contact the Lincoln Electric Service Dept. 1-(888)-953-3877.	If all recommended possible areas of misadjustment have been checked and the problem persists, Contact your local Lincoln Authorized Field Service Facility.
The Machine is dead- The Input contactor does not operate.	<ol style="list-style-type: none"> 1. Check for blown or missing fuses in input lines. 2. Check the three- phase input line voltage at the machine. The input voltage must match the rating plate and reconnect panel. 3. Power ON/OFF switch may be defective 	

⚠ CAUTION

If for any reason you do not understand the test procedures or are unable to perform the tests/repairs safely, contact your **Local Lincoln Authorized Field Service Facility** for technical troubleshooting assistance before you proceed.

IDEALARC® DC-600



Observe all Safety Guidelines detailed throughout this manual

PROBLEMS (SYMPTOMS)	POSSIBLE CAUSE	RECOMMENDED COURSE OF ACTION
OUTPUT PROBLEMS		
Input contactor (CR1) chatters.	<ol style="list-style-type: none"> 1. The input line voltage may be low. Check all three phases. 2. Make sure input line voltage matches machine rating and the reconnect panel is connected correctly for the line voltage. 	<p>If all recommended possible areas of misadjustment have been checked and the problem persists, Contact your local Lincoln Authorized Field Service Facility.</p>
Variable or sluggish welding arc.	<ol style="list-style-type: none"> 1. Poor electrode or work lead connection 2. Welding cables too small. 3. Welding current or voltage too low. 	
Output Control Pot. not functioning in "LOCAL" control.	<ol style="list-style-type: none"> 1. LOCAL/REMOTE Switch (S3) faulty or in wrong position. 2. Faulty OUTPUT CONTROL Pot. 	
No output control in "REMOTE" control.	<ol style="list-style-type: none"> 1. LOCAL/REMOTE Switch (S3) faulty or in wrong position. 2. Faulty Remote Control Unit. 	
115VAC duplex receptacle not working. (60HZ machines only)	<ol style="list-style-type: none"> 1. 115VAC Circuit Breaker tripped. 	

⚠ CAUTION

If for any reason you do not understand the test procedures or are unable to perform the tests/repairs safely, contact your **Local Lincoln Authorized Field Service Facility** for technical troubleshooting assistance before you proceed.

IDEALARC® DC-600



Observe all Safety Guidelines detailed throughout this manual

PROBLEMS (SYMPTOMS)	POSSIBLE CAUSE	RECOMMENDED COURSE OF ACTION
OUTPUT PROBLEMS		
<p>Machine input contactor operates but machine has no weld output. Fan runs and pilot light glows.</p>	<ol style="list-style-type: none"> 1. Place OUTPUT TERMINAL Switch to "ON", or install a jumper from #2 to #4 on machine terminal strip. If machine weld output is restored the problem is in the wire feeder or control cable. 2. If remote control is not being used make certain the LOCAL/REMOTE SWITCH (SW3) is in the "Local" position. 3. Check 42V Circuit Breaker in the front panel. Reset if necessary. 4. Check for loose or faulty weld cable connections. 5. Trigger circuit not working. 	<p>If all recommended possible areas of misadjustment have been checked and the problem persists, Contact your local Lincoln Authorized Field Service Facility.</p>

⚠ CAUTION

If for any reason you do not understand the test procedures or are unable to perform the tests/repairs safely, contact your **Local Lincoln Authorized Field Service Facility** for technical troubleshooting assistance before you proceed.

IDEALARC® DC-600



Observe all Safety Guidelines detailed throughout this manual

PROBLEMS (SYMPTOMS)	POSSIBLE CAUSE	RECOMMENDED COURSE OF ACTION
OUTPUT PROBLEMS		
Machine has maximum weld output and no control.	<ol style="list-style-type: none"> 1. LOCAL/REMOTE Switch (S3) in wrong position. 2. LOCAL/REMOTE Switch (S3) is faulty, or an open lead going to the LOCAL/REMOTE Switch (S3). 	<p>If all recommended possible areas of misadjustment have been checked and the problem persists, Contact your local Lincoln Authorized Field Service Facility.</p>

⚠ CAUTION

If for any reason you do not understand the test procedures or are unable to perform the tests/repairs safely, contact your **Local Lincoln Authorized Field Service Facility** for technical troubleshooting assistance before you proceed.

IDEALARC® DC-600



Observe all Safety Guidelines detailed throughout this manual

PROBLEMS (SYMPTOMS)	POSSIBLE CAUSE	RECOMMENDED COURSE OF ACTION
OUTPUT PROBLEMS		
Machine has minimum output and no control.	<ol style="list-style-type: none"> 1. If a remote control unit is NOT connected to the terminal strip #75, #76, and #77 terminals, or is not connected to the 14 pin MS receptacle the LOCAL/REMOTE SWITCH must be in the "Local" position. 2. If a remote control cable is connected to terminals #75, #76 and #77 or is connected to the 14 pin MS receptacle the leads may be "shorted" to the positive weld output. 3. Make certain the Three Phase input voltage is correct and matches the machine rating and the reconnect panel. 	<p>If all recommended possible areas of misadjustment have been checked and the problem persists, Contact your local Lincoln Authorized Field Service Facility.</p>
The machine does not have maximum weld output.	<ol style="list-style-type: none"> 1. Check all Three-Phase input lines at the DC600. Make sure input voltages match machine rating and reconnect panel. 2. Put LOCAL/REMOTE SWITCH (SW3) in "LOCAL" position. If problem is solved then check remote control unit or wire feeder. 3. Check for loose welding cable connections. 	

⚠ CAUTION

If for any reason you do not understand the test procedures or are unable to perform the tests/repairs safely, contact your **Local Lincoln Authorized Field Service Facility** for technical troubleshooting assistance before you proceed.

IDEALARC® DC-600



Observe all Safety Guidelines detailed throughout this manual

PROBLEMS (SYMPTOMS)	POSSIBLE CAUSE	RECOMMENDED COURSE OF ACTION
OUTPUT PROBLEMS		
<p>Machine shuts off (input contactor drops out) when the welder output terminals are made electrically "hot". (#2 to #4 closure at terminal strip.) or OUTPUT TERMINALS switch is in ON position.</p>	<ol style="list-style-type: none"> 1. Remove all welding cables and control cables from the DC 600. Jumper #2 to #4 at the terminal strip or set OUTPUT TERMINALS switch to ON position. If the machine does NOT shut off and normal open circuit voltage is present at the welder output terminals the problem is external to the DC600. Either the remote leads #75, #76 or #77 are grounded to the negative output cable or there is a short on the welding output terminals. 2. If the machine still shuts off when all control and welding cables are removed then the problem is internal to the DC-600. 	<p>If all recommended possible areas of misadjustment have been checked and the problem persists, Contact your local Lincoln Authorized Field Service Facility.</p>
<p>The DC600 will NOT shut off when the Power Switch is turned to OFF.</p>	<ol style="list-style-type: none"> 1. Contact your local Lincoln Authorized Field Service Facility. 	

⚠ CAUTION

If for any reason you do not understand the test procedures or are unable to perform the tests/repairs safely, contact your **Local Lincoln Authorized Field Service Facility** for technical troubleshooting assistance before you proceed.

IDEALARC® DC-600



Observe all Safety Guidelines detailed throughout this manual

PROBLEMS (SYMPTOMS)	POSSIBLE CAUSE	RECOMMENDED COURSE OF ACTION
OUTPUT PROBLEMS		
The weld output terminals are always electrically "hot".	<ol style="list-style-type: none"> 1. Remove any external leads hooked to #2 and #4 on the terminal strip or any connections to the 14 pin MS connector. Set OUTPUT TERMINALS switch to the OFF position. If the problem disappears the fault is in the control cable or wire feeder. 2. If some open circuit voltage is present (over 3VDC.) after performing Step #1. then the problem is within the IDEALARC® DC-600. 	<p>If all recommended possible areas of misadjustment have been checked and the problem persists, Contact your local Lincoln Authorized Field Service Facility.</p>

⚠ CAUTION

If for any reason you do not understand the test procedures or are unable to perform the tests/repairs safely, contact your **Local Lincoln Authorized Field Service Facility** for technical troubleshooting assistance before you proceed.

IDEALARC® DC-600



Observe all Safety Guidelines detailed throughout this manual

PROBLEMS (SYMPTOMS)	POSSIBLE CAUSE	RECOMMENDED COURSE OF ACTION
WELDING PROBLEMS		
<p>Poor arc starting when the IDEALARC® DC-600 is in the CV Sub-Arc or CV Innershield Modes.</p>	<ol style="list-style-type: none"> 1. Make sure the proper welding procedures are being used. (wire feed speed , arc voltage and wire size) 2. Check weld cables for loose or faulty connections. 	<p>If all recommended possible areas of misadjustment have been checked and the problem persists, Contact your local Lincoln Authorized Field Service Facility.</p>
<p>Machine has output but trips off immediately when wire feed unit trigger is activated</p>	<ol style="list-style-type: none"> 1. Remove output cables from IDEALARC® DC-600. If problem is resolved check for external short between welding cables. Also check control cable (#75, #76, & #77) for grounds or shorts. 	

⚠ CAUTION

If for any reason you do not understand the test procedures or are unable to perform the tests/repairs safely, contact your **Local Lincoln Authorized Field Service Facility** for technical troubleshooting assistance before you proceed.

IDEALARC® DC-600



Observe all Safety Guidelines detailed throughout this manual

PROBLEMS (SYMPTOMS)	POSSIBLE CAUSE	RECOMMENDED COURSE OF ACTION
WELDING PROBLEMS		
<p>Poor arc characteristics in all processes.</p>	<ol style="list-style-type: none"> 1. Check for the correct input voltages on the three- phase input lines at the IDEALARC® DC-600. 2. Make sure the proper welding procedures are being used. (wire feed speed, arc voltage and wire size). 3. Check the welding cables for loose or faulty connections. 	<p>If all recommended possible areas of misadjustment have been checked and the problem persists, Contact your local Lincoln Authorized Field Service Facility.</p>

⚠ CAUTION

If for any reason you do not understand the test procedures or are unable to perform the tests/repairs safely, contact your **Local Lincoln Authorized Field Service Facility** for technical troubleshooting assistance before you proceed.

IDEALARC® DC-600



Observe all Safety Guidelines detailed throughout this manual

PC BOARD TROUBLESHOOTING GUIDE FIRING P.C. BOARD

1. All 10 LED's must be ON when the POWER SOURCE is turned "ON" and the trigger circuit* is closed.
2. LED's 7, 8, and 9 indicate AC power being supplied to the P.C. board from auxiliary windings on the main transformer (T1). If a LED is not "ON", turn the machine off and unplug P5 from the firing board. Turn the machine back on and check the following voltages:

LED that was off	Check AC voltage between pins specified, it should be approximately 32VAC .
7	P5 pins 15 & 16 (wires 203,204)
8	P5 pins 7 & 8 (wires 205,206)
9	P5 pins 5 & 6 (wires 207,208)

3. If all voltages are present, turn power off, and plug P5 back into J5. Turn power back on. If LED's are still "OUT", replace Firing PCB.
4. If voltages were not present then check the wiring back to the auxiliary windings for a possible open.
5. LED 10 senses when trigger circuit* is closed. Close trigger circuit, LED10 should be on be "ON". Open trigger circuit, LED 10 should be "OFF". If LED does not come "ON", check to make sure leads 2,4, or 41 are not broken.
6. LED's 1 through 6 indicate gate signals are being sent to the main SCR's 1 through 6 respectively. If LED 5 (located on Control Board) is "ON", along with LED's 7, 8, and 9 (on Firing PCB), and LED's 1 through 6 are "OFF", check to make sure lead 231 between Control board and Firing board is not broken
7. If any one of LED's 1 through 6 are "OFF" and LED's 7, 8, and 9 are "ON", replace the Firing PCB.

PC BOARD TROUBLESHOOTING GUIDE CONTROL P.C. BOARD

1. LED 1 indicates AC input voltage necessary to generate the DC supply voltages is present. These voltages power the Control board circuitry. If LED 1 is not "ON" when machine POWER is "ON", check leads 255, 256, X1, and X2 for broken connection.

Voltage across leads 255 and 256 should be approximately 115VAC. Check voltage across secondary winding of the control transformer (T2) which supplies leads 255 and 256. Measure +16VDC from TEST POINTS "A" to "C" and -10VDC from TEST POINTS "A" to "J" on Control board.

2. LED 2 indicates welder output voltage is being supplied to the control circuit. LED 2 will be "ON" brightly in CC STICK mode with trigger circuit* closed and no load. (LED 2 diminishes in brightness as output voltage is reduced). If LED 2 is not "ON", look for open connection in lead 222 circuit.
3. LED 3 indicates power is being applied to FAULT PROTECTION RELAY (CR2). LED 3 will be "ON" when machine POWER is "ON". LED 3 goes "OUT" when CR2 drops out which turns off the INPUT CONTACTOR (CR1). When LED 3 goes out, LED 4 comes "ON". See step 3.
4. LED 4 indicates an overload or fault condition; LED should not be on. If this LED comes "ON", the INPUT CONTACTOR (CR1) will turn off and the red POWER light stays illuminated. This was do to either a short across output, or a current draw in excess of 780A, or leads 75, 76, or 77 grounded to negative output lead. Remove short or reduce output current or eliminate ground. Welder must be reset by turning POWER ON/OFF switch to "OFF" and then back to "ON". If no short or loads above 780A exists or no ground, replace Control PCB.
5. LED 5 indicates DC control voltage (which supplies Firing board) is present. LED 5 will be "ON" in CV INNERSHIELD mode with trigger circuit* closed, CONTROL POT at minimum, and no load. (LED 5 diminishes in brightness as output voltage is increased). Replace P.C. board if LED 5 did not go "ON".
6. LED 6 indicates trigger circuit* condition. LED 6 "ON" indicates trigger circuit is closed. LED 6 "OFF" indicates trigger circuit is open. If LED 6 does not come "ON", when trigger circuit closed, look for open connections in the 2 & 4 circuit and in leads 290 and 291.

TRIGGER CIRCUIT is closed by any of the following:

- Wire feeder's trigger is closed.
- A jumper is placed across 2 & 4 on terminal strip T.S.2. or across pins C & D in 14 pin connector.
- OUTPUT TERMINAL switch is in the "ON" position.

CAUTION



If for any reason you do not understand the test procedures or are unable to perform the tests/repairs safely, contact your **Local Lincoln Authorized Field Service Facility** for technical troubleshooting assistance before you proceed.

IDEALARC® DC-600



Observe all Safety Guidelines detailed throughout this manual

CHECKING POWER ON/OFF SWITCH (S1)

1. Turn off the machine input power ("  " position). SW1 has 115 volts across it when the input power is connected.
2. Isolate the switch to be tested by removing all connecting leads.
3. Check to make sure the switch is making open and closed connections with a V.O.M. meter. Put ohm meter on X1 scale. The meter should read zero resistance with switch "  " and infinite with switch "  "
4. Put the ohmmeter on X1K scale and measure the resistance between the terminal and the case of the machine (touch a self-tapping screw). Reading should be infinite.
5. If either step (3) or step (4) fails, replace the switch.

CHECKING OUTPUT CONTROL RHEOSTAT ON MACHINE (R1)

1. Turn machine off ("  " position).
2. Remove the screws from the hinged control panel and open the panel.
3. Turn the LOCAL/REMOTE CONTROL switch to "REMOTE".
4. With an ohmmeter on X1K, connect it to lead 236 and 237 on R1.
5. Exercise caution to avoid damaging rheostat tabs.
6. Rotate the OUTPUT voltage control rheostat. The resistance reading should be from around zero to 10K ohms. Check the resistance reading between the two outer tabs on the rheostat (leads 236 and 75). The reading must be 10K "10% ohms. No reading will indicate an open rheostat and a low reading will indicate a shorted or partially shorted rheostat; in either case, replace.

CONNECTING REMOTE OUTPUT CONTROL RHEOSTAT TO THE MACHINE

Extreme caution must be observed when installing or extending the wiring of a remote control. Improper connection of this unit can lead to loss of control and/or poor welding. Only the green lead can and should be grounded to the machine case. When extending the standard remote control, make sure the leads are the same and the splice is waterproof. Be very careful not to ground the cable when in use and don't let the lugs touch against the case.

CHECKING REMOTE OUTPUT CONTROL RHEOSTAT

Disconnect the remote output control and connect an ohmmeter across 75 and 76 and rotate the rheostat in the remote control. The resistance reading should go from zero to 10K ohms. Repeat with ohmmeter across 77 and 76 with same results. Connect ohmmeter across 75 and 77. The reading should be 10K "10% ohms. A lower reading will indicate a shorted or partially shorted rheostat. A very high reading will indicate an open rheostat. In either of the last two cases, replace rheostat. Check cable for any physical damage.

CAUTION

If for any reason you do not understand the test procedures or are unable to perform the tests/repairs safely, contact your **Local Lincoln Authorized Field Service Facility** for technical troubleshooting assistance before you proceed.

IDEALARC® DC-600



WIRING DIAGRAM FOR CODES 10588, 10701, 11129, 11130, 11131, 11140, 11135, 11336, 11337, 11339

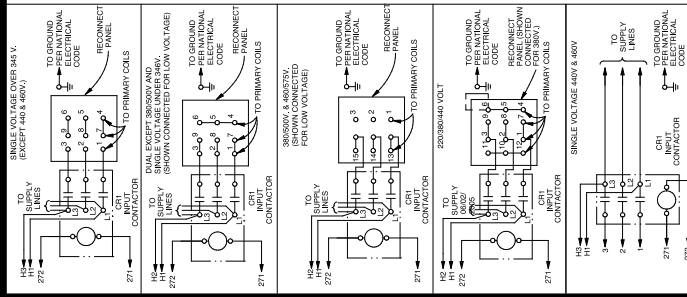
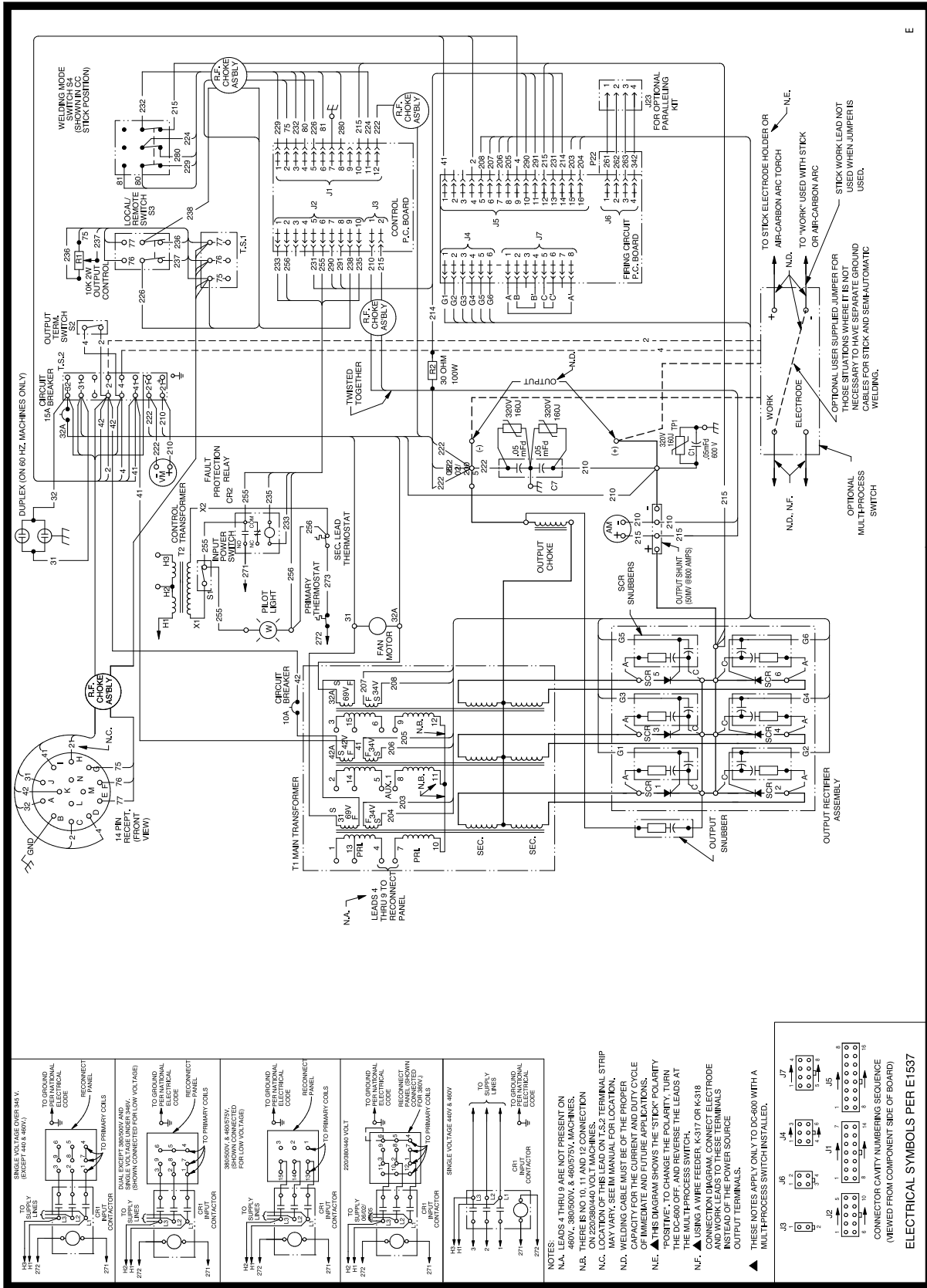

NOTES:
 N.A. LEADS 4 THRU 9 ARE NOT PRESENT ON 460V, 380/500V, & 460/575V MACHINES.
 N.B. THERE IS NO 11 AND 12 CONNECTION CAPACITY FOR THE CURRENT AND DUTY CYCLE OF IMMEDIATE AND FUTURE APPLICATIONS.
 N.E. THIS DIAGRAM SHOWS THE "STICK" POLARITY. THE "DIP" POLARITY IS SHOWN IN THE MULTIPROCESS SWITCH.
 N.F. USING A WIRE FEEDER, K-317 OR K-318 CONNECTION DIAGRAM, CONNECT ELECTRODE AND WORK LEADS TO THESE TERMINALS AND OUTPUT TERMINALS.
 ▲ THESE NOTES APPLY ONLY TO DC-600 WITH A MULTIPROCESS SWITCH INSTALLED.

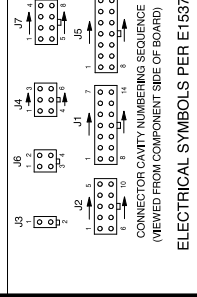

ELECTRICAL SYMBOLS PER E1537

NOTE: This diagram is for reference only. It may not be accurate for all machines covered by this manual. The specific diagram for a particular code is pasted inside the machine on one of the enclosure panels. If the diagram is illegible, write to the Service Department for a replacement. Give the equipment code number.

WIRING DIAGRAM FOR CODES 11070, 11071, 11072, 11132, 11133, 11338

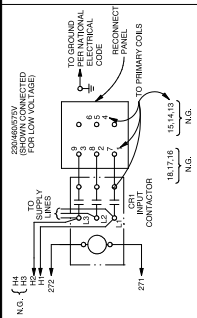
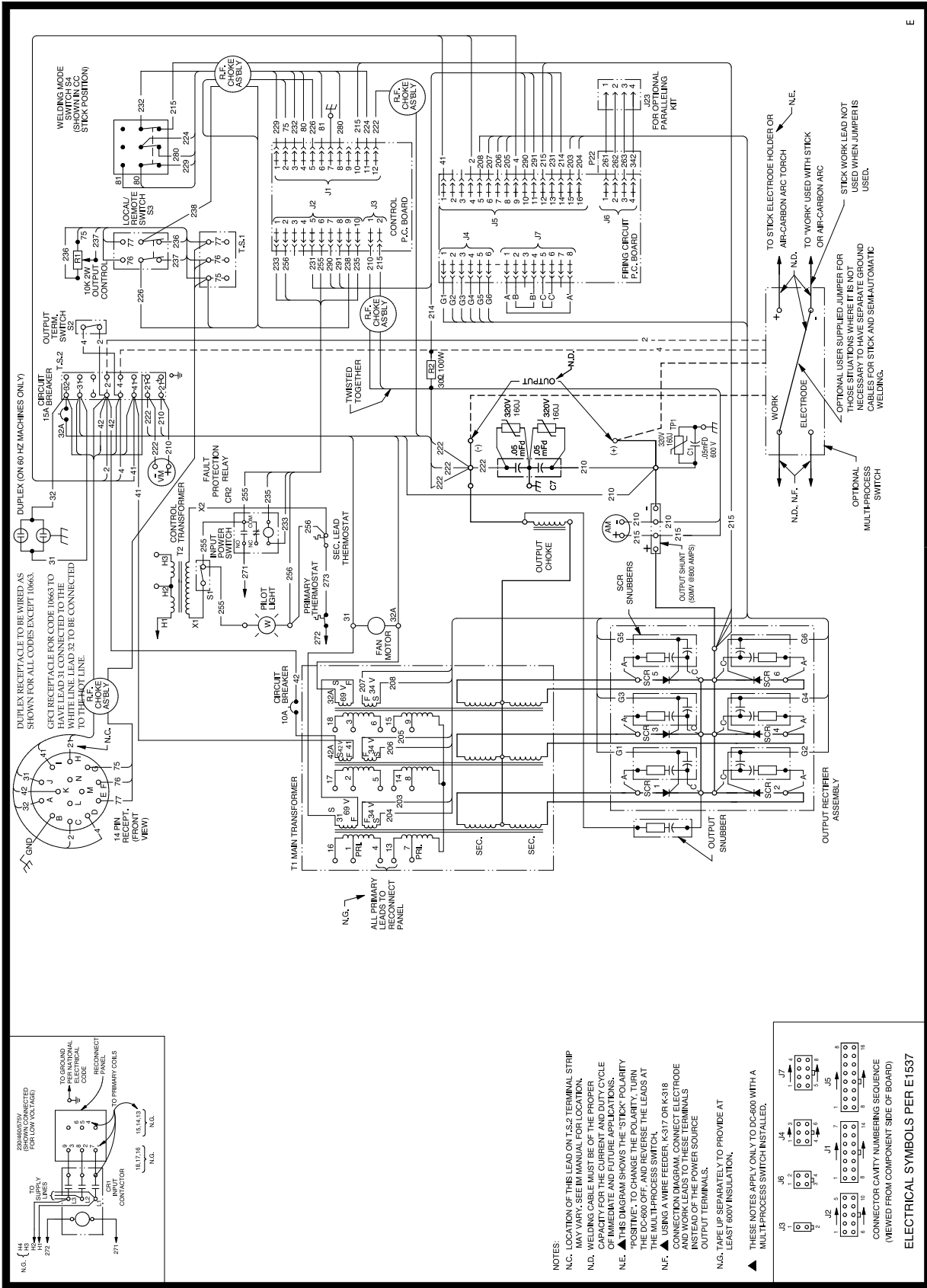

- NOTES:
- NOTE: LOCATION OF THIS LEAD ON T.S.2 TERMINAL STRIP MAY VARY. SEE IM MANUAL FOR LOCATION.
 - N.D. WELDING CABLE MUST BE OF THE PROPER CAPACITY FOR THE CURRENT AND DUTY CYCLE IMMEDIATE AND FUTURE APPLICATIONS.
 - N.E. IMMEDIATE AND FUTURE APPLICATIONS. POSITIVE TO CHANGE THE POLARITY, TURN THE DC-600 OFF AND REVERSE THE LEADS AT THE MULTI-PROCESS SWITCH.
 - N.F. USING A WIRE FEEDER, K-317 OR K-318 CONNECTION DIAGRAM, CONNECT ELECTRODE TO THESE TERMINALS INSTEAD OF THE POWER SOURCE OUTPUT TERMINALS.
 - N.G. TAKE UP SEPARATELY TO PROVIDE AT LEAST 600V INSULATION.
 - ▲ THESE NOTES APPLY ONLY TO DC-600 WITH A MULTI-PROCESS SWITCH INSTALLED.

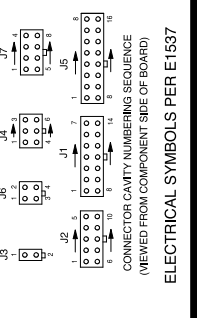

NOTE: This diagram is for reference only. It may not be accurate for all machines covered by this manual. The specific diagram for a particular code is pasted inside the machine on one of the enclosure panels. If the diagram is illegible, write to the Service Department for a replacement. Give the equipment code number.

WIRING DIAGRAM FOR CODES 11537, 11538, 11540, 11541, 11568

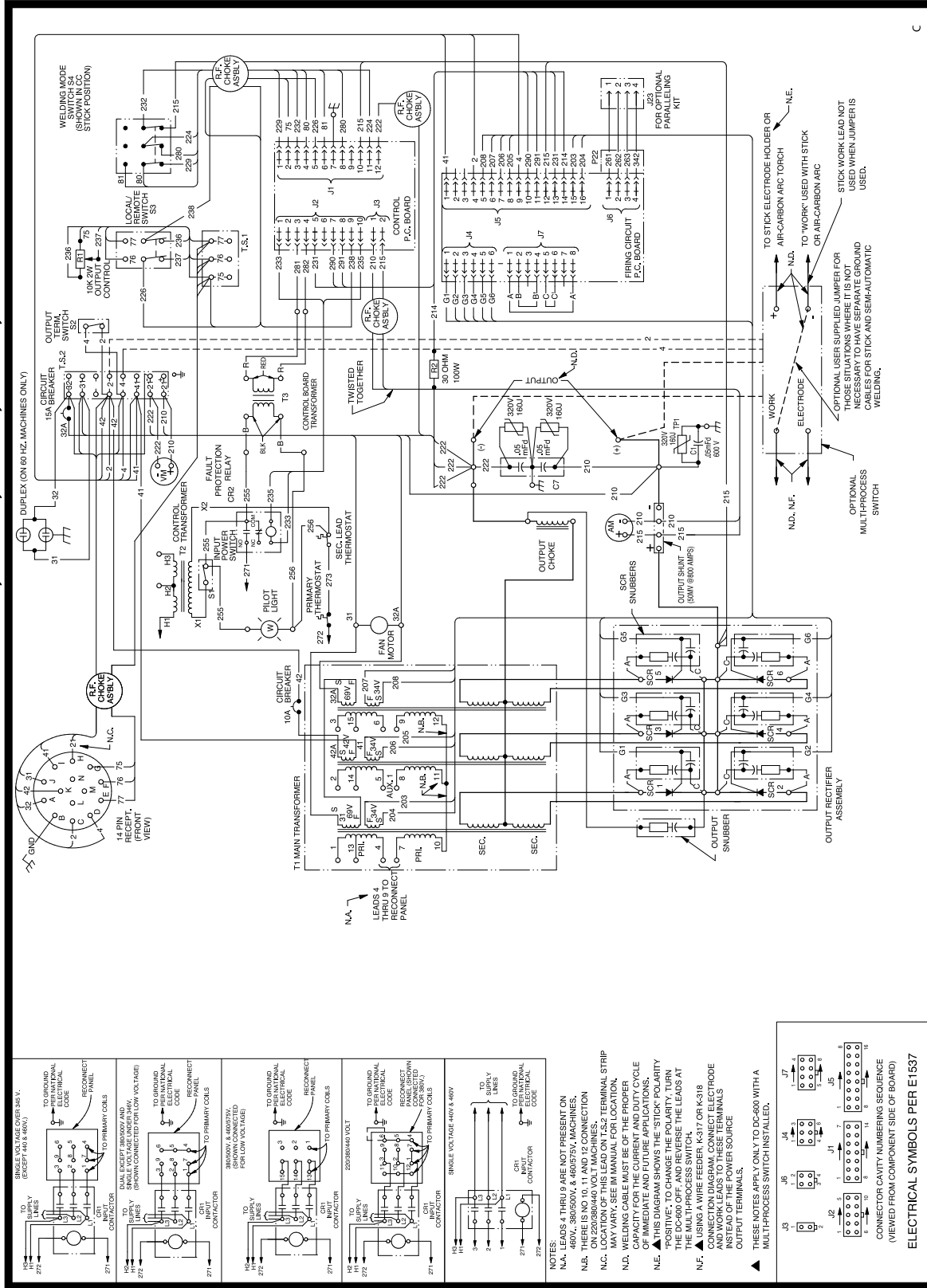

G3506-2

NOTE: This diagram is for reference only. It may not be accurate for all machines covered by this manual. The specific diagram for a particular code is pasted inside the machine on one of the enclosure panels. If the diagram is illegible, write to the Service Department for a replacement. Give the equipment code number.

WIRING DIAGRAM FOR CODE 11539

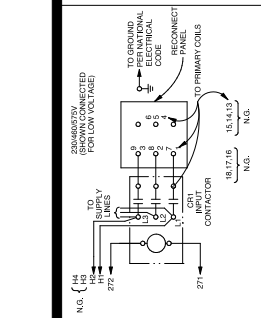
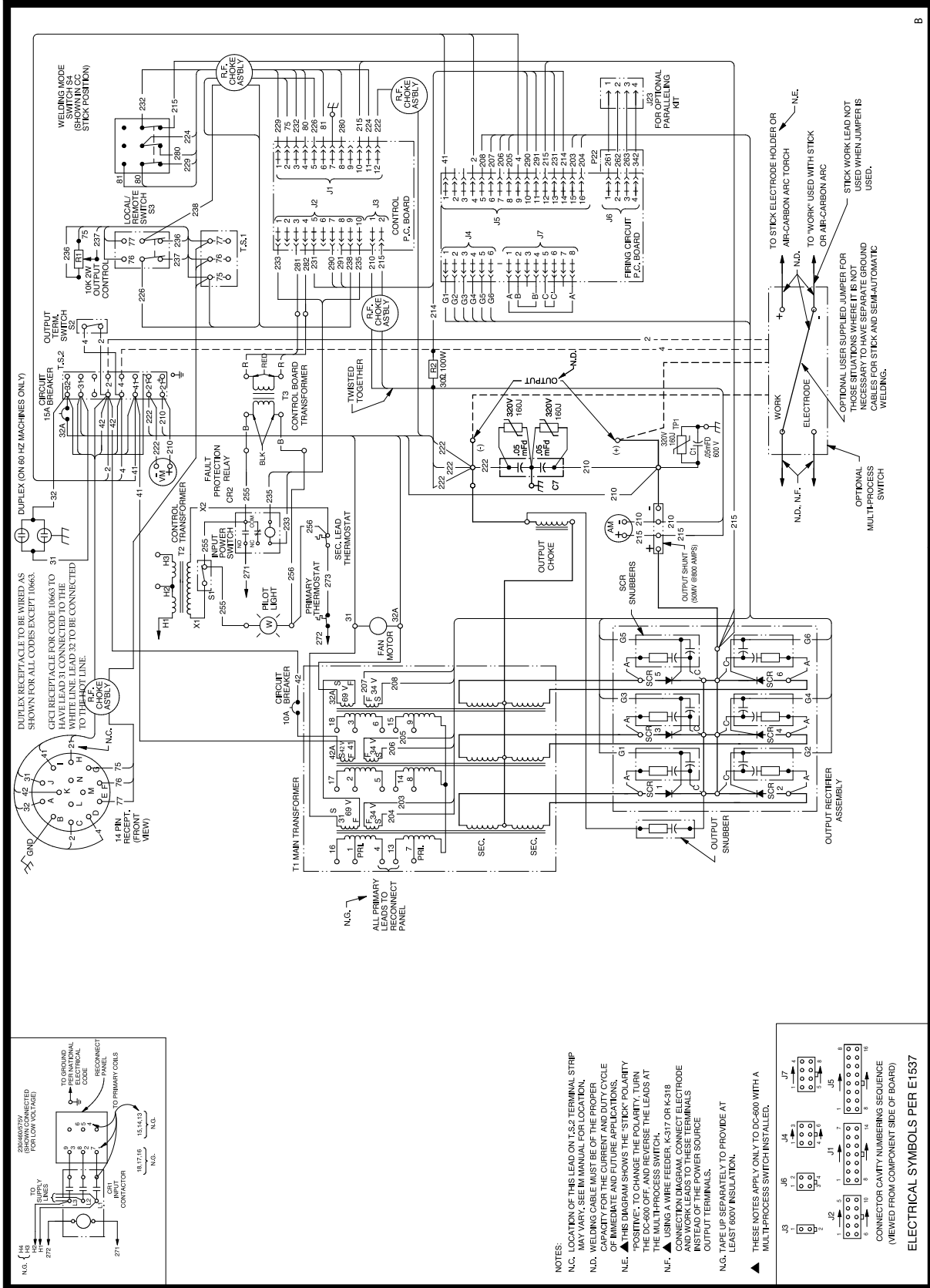

NOTE: This diagram is for reference only. It may not be accurate for all machines covered by this manual. The specific diagram for a particular code is pasted inside the machine on one of the enclosure panels. If the diagram is illegible, write to the Service Department for a replacement. Give the equipment code number.

G3506-3

CONNECTION OF LN-742 TO THE CV-655, DC-655 OR DC-600 POWER SOURCE

WARNING

• Turn off (0) the power switch on the Welding Power Source before connecting the wire feeder.

• Only qualified persons should install, use or service this machine.

ELECTRIC SHOCK CAN KILL

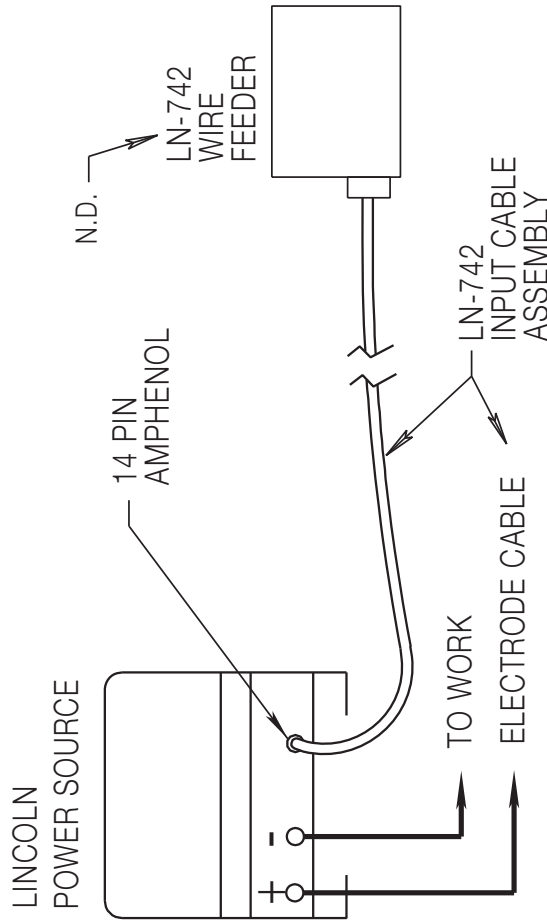

- N.A. WELDING CABLE MUST BE SIZED FOR CURRENT AND DUTY CYCLE OF APPLICATION.
- N.B. DIAGRAM SHOWS ELECTRODE POSITIVE. TO CHANGE POLARITY, TURN POWER "OFF", REVERSE ELECTRODE AND WORK CABLES AT POWER SOURCE AND SET WIRE FEEDER VOLT/METER POLARITY SWITCH ON POWER SOURCE TO PROPER POLARITY.
- N.C. PINS NOT LISTED ARE NOT CONNECTED ON CABLE.
- N.D. IF USING K589-1, REMOTE CONTROL KIT, SET POWER SOURCE CONTROL SWITCH TO "REMOTE" POSITION.

FUNCTIONS ARE LISTED FOR REFERENCE ONLY AND EACH MAY OR MAY NOT BE PRESENT IN YOUR EQUIPMENT.
(SEE APPROPRIATE WIRING DIAGRAM)

PIN	LEAD	FUNCTION
C	2	TRIGGER CIRCUIT
D	4	TRIGGER CIRCUIT
E	77	OUTPUT CONTROL
F	76	OUTPUT CONTROL
G	75	OUTPUT CONTROL
H	21	WORK
I	41	42V AC
K	42	42V AC

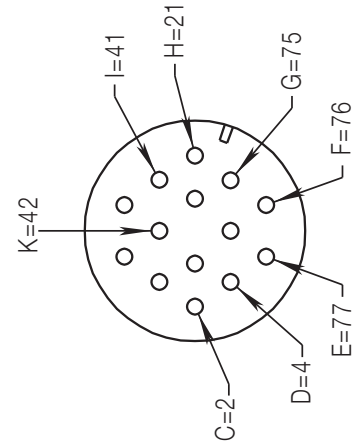

14-SOCKET BOX RECEPTACLE, FRONT VIEW AND 14-PIN CABLE PLUG, REAR VIEW

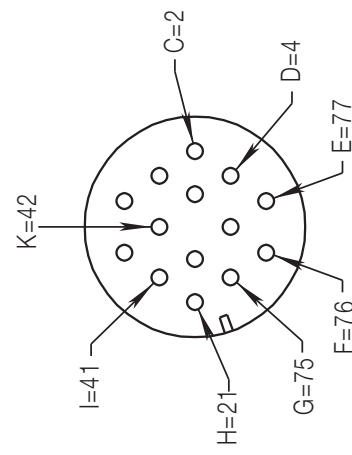

14-SOCKET BOX RECEPTACLE, REAR VIEW AND 14-PIN CABLE PLUG, FRONT VIEW

1-28-94

S20409

CONNECTION OF LN-7 TO THE CV-655, DC-655 OR DC-600 POWER SOURCE

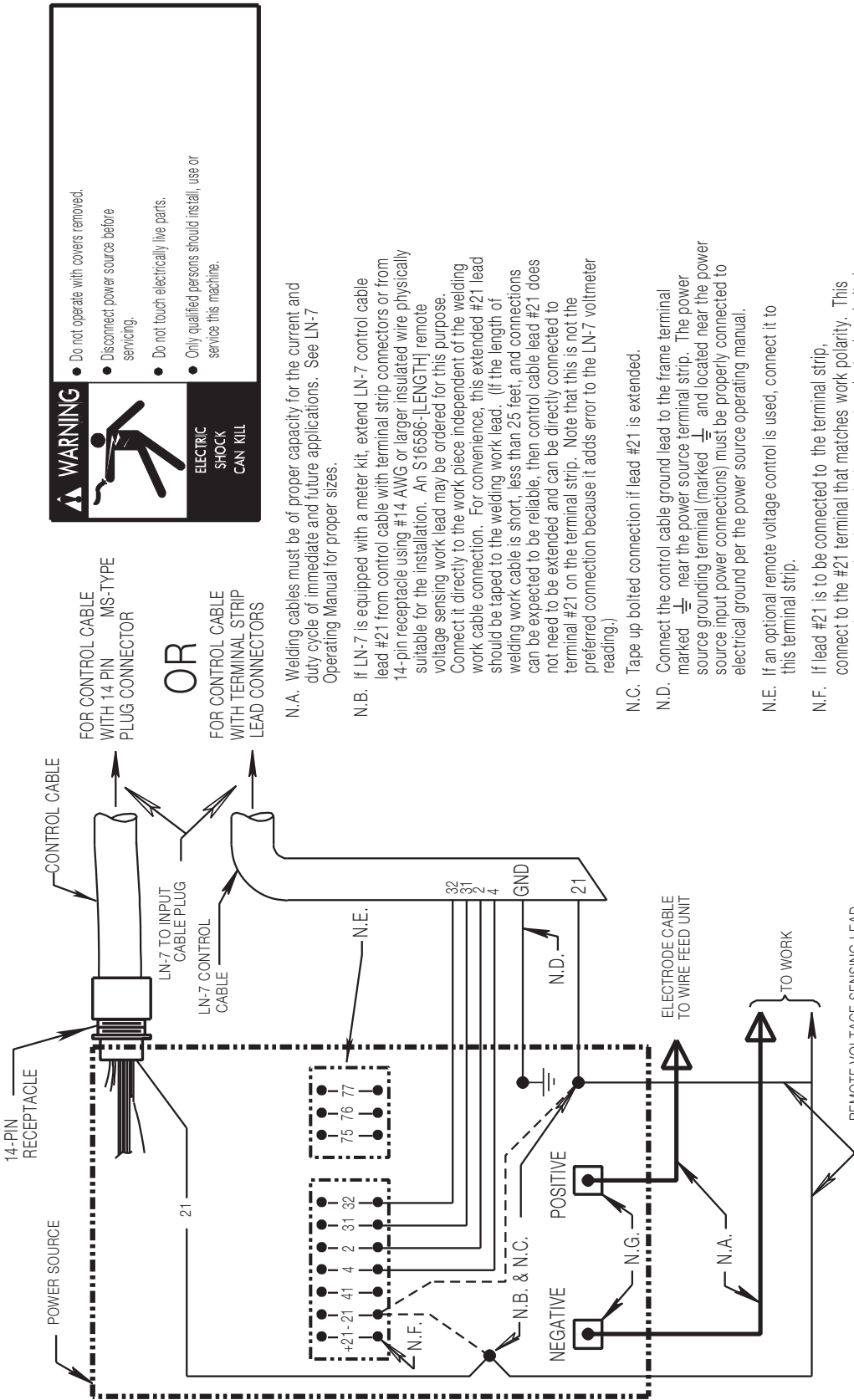

WARNING

- Do not operate with covers removed.
- Disconnect power source before servicing.
- Do not touch electrically live parts.
- Only qualified persons should install, use or service this machine.

ELECTRIC SHOCK CAN KILL

N.A. Welding cables must be of proper capacity for the current and duty cycle of immediate and future applications. See LN-7 Operating Manual for proper sizes.

N.B. If LN-7 is equipped with a meter kit, extend LN-7 control cable lead #21 from control cable with terminal strip connectors or from 14-pin receptacle using #14 AWG or larger insulated wire physically suitable for the installation. An S16586-[LENGTH] remote voltage sensing work lead may be ordered for this purpose. Connect it directly to the work piece independent of the welding work cable connection. For convenience, this extended #21 lead should be taped to the welding work lead. (If the length of welding work cable is short, less than 25 feet, and connections can be expected to be reliable, then control cable lead #21 does not need to be extended and can be directly connected to terminal #21 on the terminal strip. Note that this is not the preferred connection because it adds error to the LN-7 voltmeter reading.)

N.C. Tape up bolted connection if lead #21 is extended.

N.D. Connect the control cable ground lead to the frame terminal marked $\frac{\text{—}}{\text{—}}$ near the power source terminal strip. The power source grounding terminal (marked $\frac{\text{—}}{\text{—}}$ and located near the power source input power connections) must be properly connected to electrical ground per the power source operating manual.

N.E. If an optional remote voltage control is used, connect it to this terminal strip.

N.F. If lead #21 is to be connected to the terminal strip, connect to the #21 terminal that matches work polarity. This connection must be changed whenever the electrode polarity is changed.

N.G. Illustration does not necessarily represent actual position of appropriate output studs. Refer to power source operating manual for more information.

Above diagram shows electrode connected positive. To change polarity, turn power off, reverse the electrode and work leads at the power source and position the switch on wire feeder (if equipped) to proper polarity. Also refer to note N.F.

For proper setting of switches on power source, see power source operating manual.

10-30-88F

S22976

CONNECTION OF LN-8 OR LN-9 TO THE CV-655, DC-655 OR DC-600 POWER SOURCE

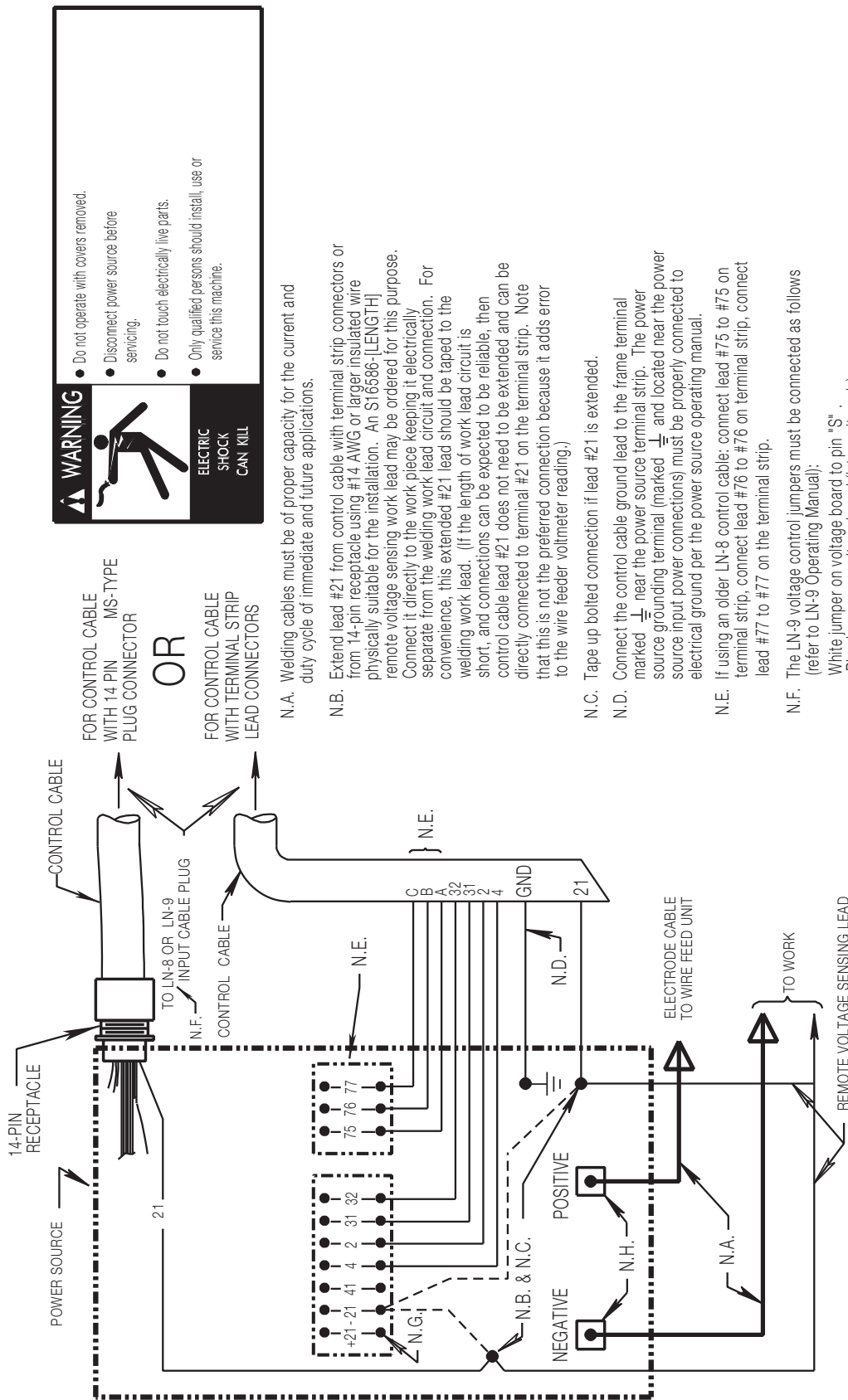

Above diagram shows electrode connected positive. To change polarity, turn power off, reverse the electrode and work leads at the power source and position the switch on wire reeler (if equipped) to proper polarity. Also refer to note N.F.

For proper setting of switches on power source, see power source operating manual.

CONNECTION OF NA-3, LT-5 OR LT-7 TO THE CV-655*, DC-655 OR DC-600 POWER SOURCE

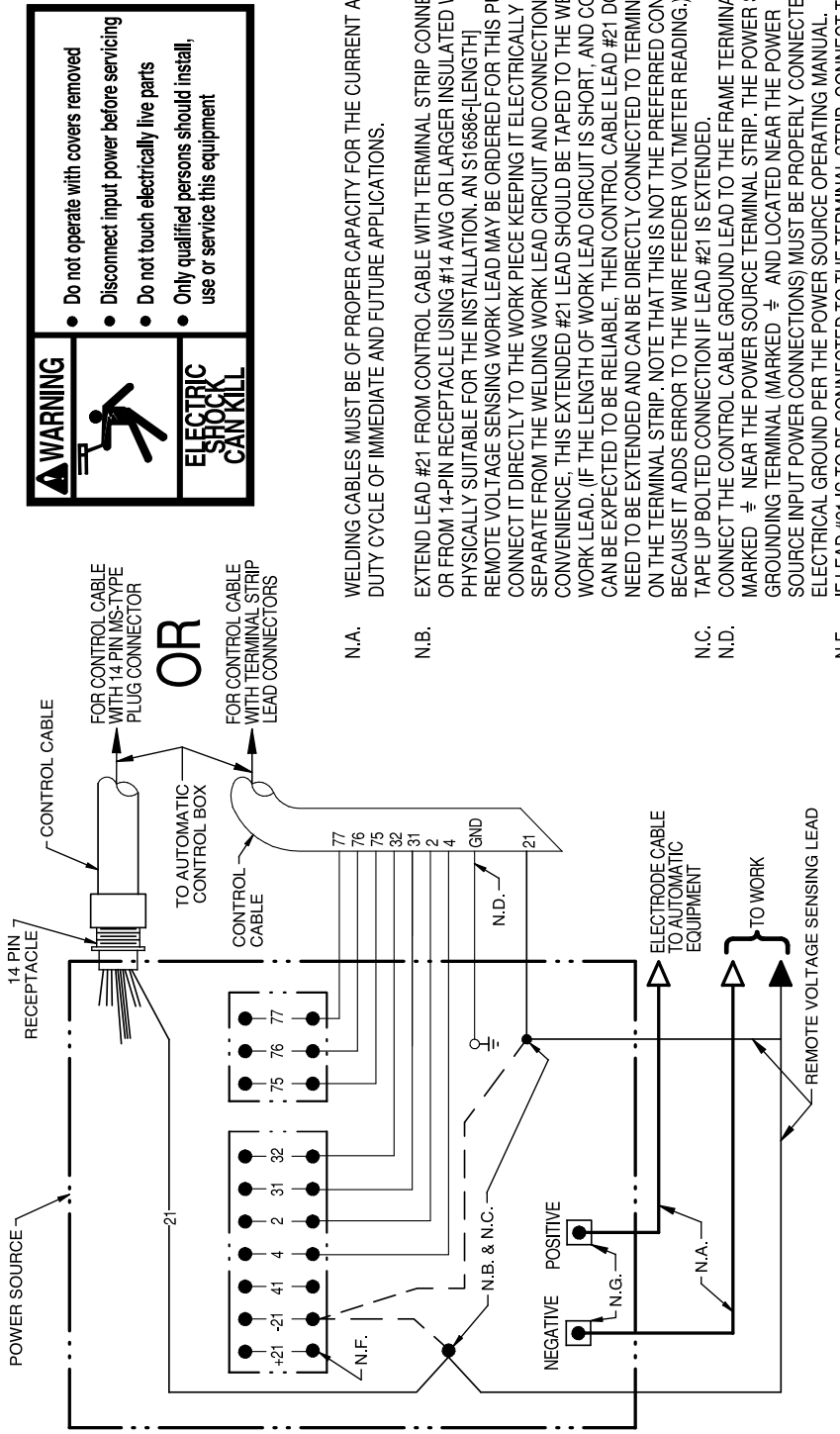

WARNING

ELECTRIC SHOCK CAN KILL

- Do not operate with covers removed
- Disconnect input power before servicing
- Do not touch electrically live parts
- Only qualified persons should install, use or service this equipment

- N.A. WELDING CABLES MUST BE OF PROPER CAPACITY FOR THE CURRENT AND DUTY CYCLE OF IMMEDIATE AND FUTURE APPLICATIONS.
- N.B. EXTEND LEAD #21 FROM CONTROL CABLE WITH TERMINAL STRIP CONNECTORS OR FROM 14-PIN RECEPTACLE USING #14 AWG OR LARGER INSULATED WIRE PHYSICALLY SUITABLE FOR THE INSTALLATION. AN S16586-[LENGTH] REMOTE VOLTAGE SENSING WORK LEAD MAY BE ORDERED FOR THIS PURPOSE. CONNECT IT DIRECTLY TO THE WORK PIECE KEEPING IT ELECTRICALLY SEPARATE FROM THE WELDING WORK LEAD CIRCUIT AND CONNECTION. FOR CONVENIENCE, THIS EXTENDED #21 LEAD SHOULD BE TAPED TO THE WELDING WORK LEAD; (IF THE LENGTH OF WORK LEAD CIRCUIT IS SHORT, AND CONNECTIONS CAN BE EXPECTED TO BE RELIABLE, THEN CONTROL CABLE LEAD #21 DOES NOT NEED TO BE EXTENDED AND CAN BE DIRECTLY CONNECTED TO TERMINAL #21 ON THE TERMINAL STRIP. NOTE THAT THIS IS NOT THE PREFERRED CONNECTION BECAUSE IT ADDS ERROR TO THE WIRE FEEDER VOLTMETER READING.)
- N.C. TAPE UP BOLTED CONNECTION IF LEAD #21 IS EXTENDED.
- N.D. CONNECT THE CONTROL CABLE GROUND LEAD TO THE FRAME TERMINAL MARKED \oplus NEAR THE POWER SOURCE TERMINAL STRIP. THE POWER SOURCE GROUNDING TERMINAL (MARKED \ominus AND LOCATED NEAR THE POWER SOURCE INPUT POWER CONNECTIONS) MUST BE PROPERLY CONNECTED TO ELECTRICAL GROUND PER THE POWER SOURCE OPERATING MANUAL.
- N.F. IF LEAD #21 IS TO BE CONNECTED TO THE TERMINAL STRIP, CONNECT TO THE #21 TERMINAL THAT MATCHES WORK POLARITY. THIS CONNECTION MUST BE CHANGED WHENEVER THE ELECTRODE POLARITY IS CHANGED.
- N.G. ILLUSTRATION DOES NOT NECESSARILY REPRESENT ACTUAL POSITION OF APPROPRIATE OUTPUT STUDS. REFER TO POWER SOURCE OPERATING MANUAL FOR MORE INFORMATION.

* CV-655 REQUIRES TH VOLTAGE BOARD JUMPER IN THE NA-5 YO BE ON "AUTO".

ABOVE DIAGRAM SHOWS ELECTRODE CONNECTED POSITIVE. TO CHANGE POLARITY, TURN POWER OFF. REVERSE THE ELECTRODE AND WORK LEADS AT THE POWER SOURCE. REVERSE THE LEADS ON THE BACK OF THE AMMETER AND VOLTMETER IN THE AUTOMATIC CONTROL BOX. ALSO REFER TO NOTE N.F.

FOR PROPER SETTING OF SWITCHES ON POWER SOURCE, SEE POWER SOURCE OPERATION MANUAL.

A.01

S22978

CONNECTION OF NA-5/5-R TO THE CV-655*, DC-655 OR DC-600 POWER SOURCE

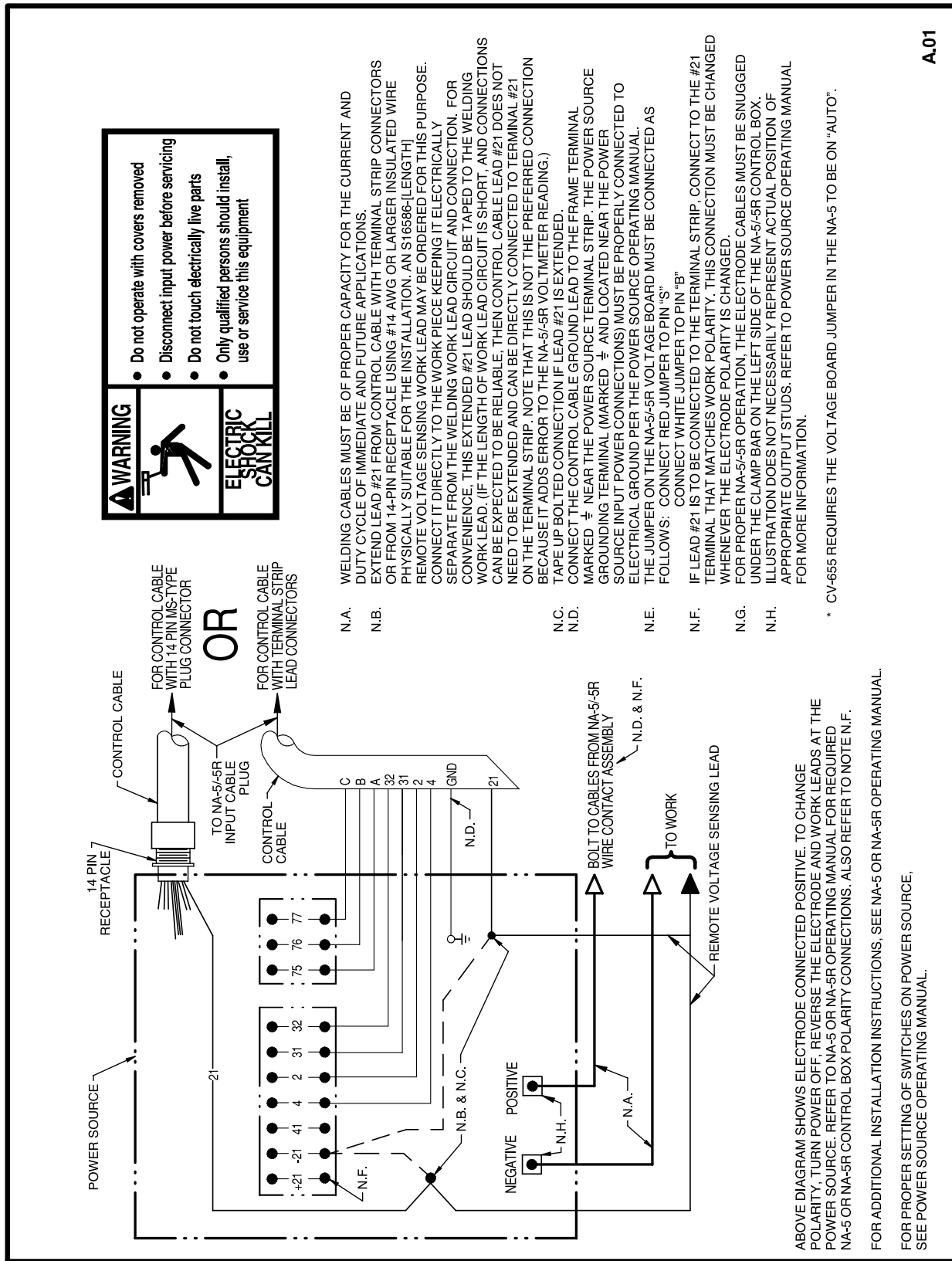

ABOVE DIAGRAM SHOWS ELECTRODE CONNECTED POSITIVE. TO CHANGE POLARITY, TURN POWER OFF, REVERSE THE ELECTRODE AND WORK LEADS AT THE POWER SOURCE. REFER TO NA-5 OR NA-5R OPERATING MANUAL FOR REQUIRED NA-5 OR NA-5R CONTROL BOX POLARITY CONNECTIONS. ALSO REFER TO NOTE N.F.

FOR ADDITIONAL INSTALLATION INSTRUCTIONS, SEE NA-5 OR NA-5R OPERATING MANUAL. FOR PROPER SETTING OF SWITCHES ON POWER SOURCE, SEE POWER SOURCE OPERATING MANUAL.

CONNECTION OF DH-10 OR LN-10 TO POWER SOURCE WITH 14 PIN AMPHENOL

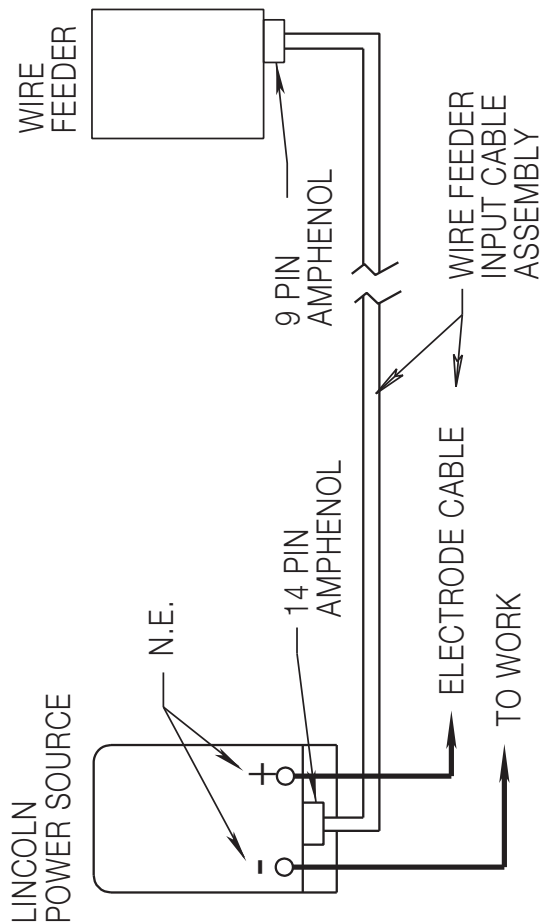

- Do not operate with covers removed.
- Disconnect power source before servicing.
- Do not touch electrically live parts.
- Only qualified persons should install, use or service this machine.

ELECTRIC SHOCK CAN KILL

N.A. WELDING CABLE MUST BE SIZED FOR CURRENT AND DUTY CYCLE OF APPLICATION.

N.B. DIAGRAM SHOWS ELECTRODE POSITIVE. TO CHANGE POLARITY, TURN POWER "OFF", REVERSE ELECTRODE AND WORK CABLES AT POWER SOURCE.

N.C. PINS NOT LISTED ARE NOT CONNECTED ON CABLE.

N.D. IF LEAD #21 IS TO BE CONNECTED TO THE TERMINAL STRIP, CONNECT TO THE #21 TERMINAL THAT MATCHES WORK POLARITY. THIS CONNECTION MUST BE CHANGED WHENEVER THE ELECTRODE POLARITY IS CHANGED.

N.E. ILLUSTRATION DOES NOT NECESSARILY REPRESENT ACTUAL POSITION OF APPROPRIATE OUTPUT STUDS. REFER TO POWER SOURCE OPERATING MANUAL FOR MORE INFORMATION.

FOR PROPER SETTINGS OF SWITCHES ON POWER SOURCE, SEE POWER SOURCE OPERATING MANUAL.

FUNCTIONS ARE LISTED FOR REFERENCE ONLY AND EACH MAY OR MAY NOT BE PRESENT IN YOUR EQUIPMENT.
(SEE APPROPRIATE WIRING DIAGRAM)

PIN	LEAD	FUNCTION
B	GND	CHASSIS CONNECTION
C	2	TRIGGER CIRCUIT
D	4	TRIGGER CIRCUIT
E	77	OUTPUT CONTROL
F	76	OUTPUT CONTROL
G	75	OUTPUT CONTROL
H	21	WORK
I	41	42V AC
K	42	42V AC

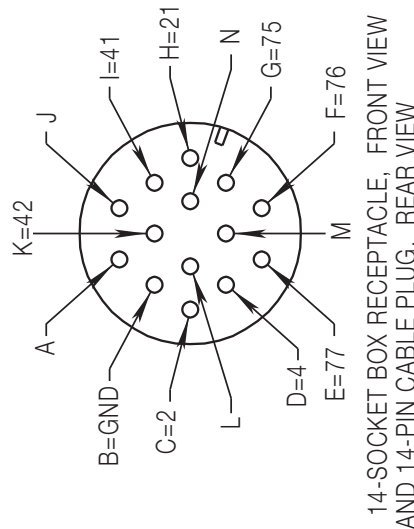

14-SOCKET BOX RECEPTACLE, FRONT VIEW AND 14-PIN CABLE PLUG, FRONT VIEW

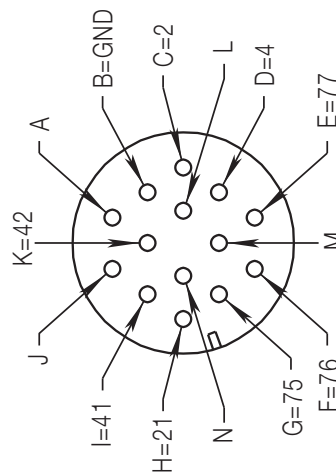

14-SOCKET BOX RECEPTACLE, REAR VIEW AND 14-PIN CABLE PLUG, FRONT VIEW

10-30-98F

S22980

DC-600 DIMENSION PRINT (WITH K817P UNDERCARRIAGE)

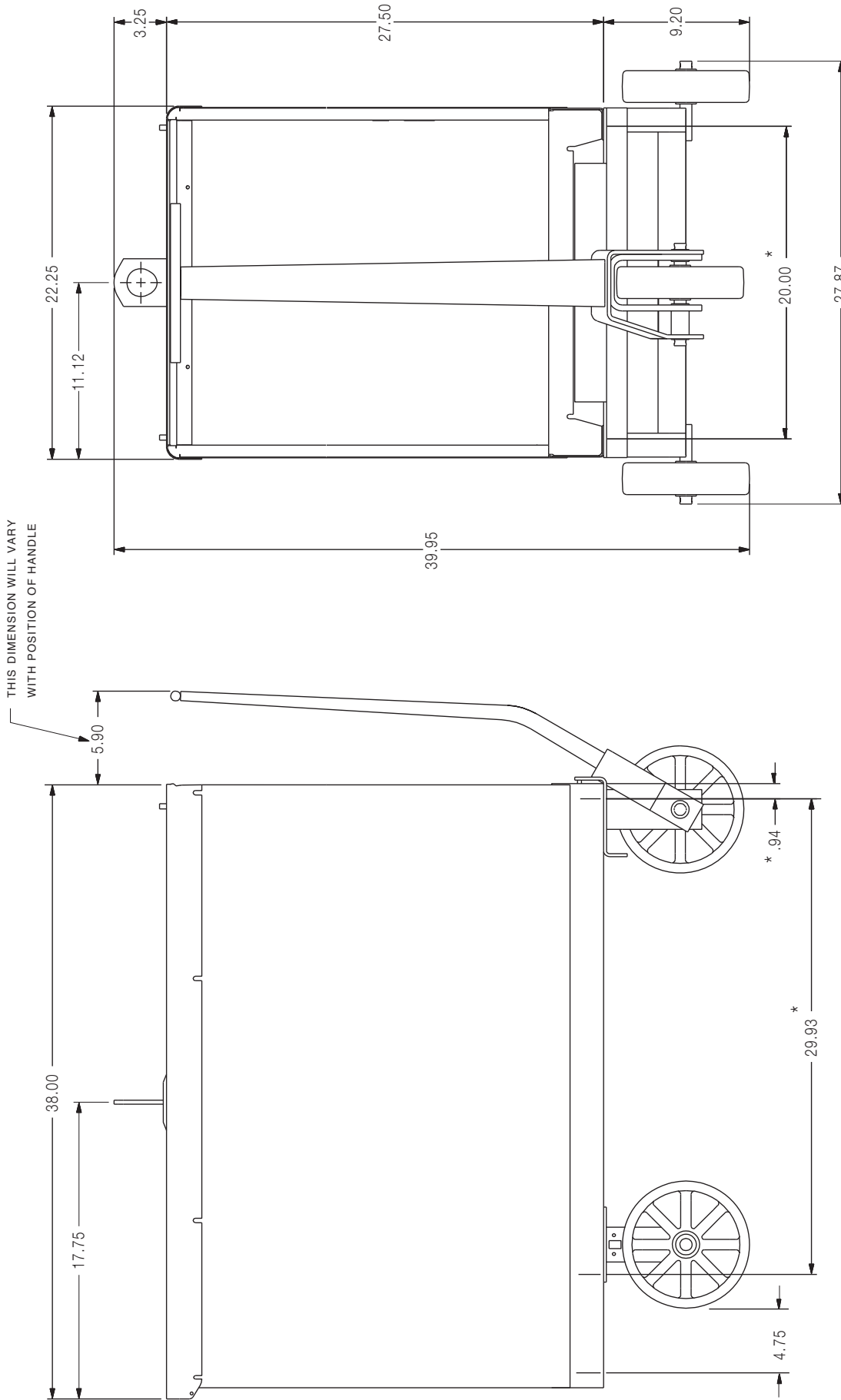

1-20-89A

M12244-6

IDEALARC® DC-600



DC-600 DIMENSION PRINT (WITH K842 UNDERCARRIAGE)

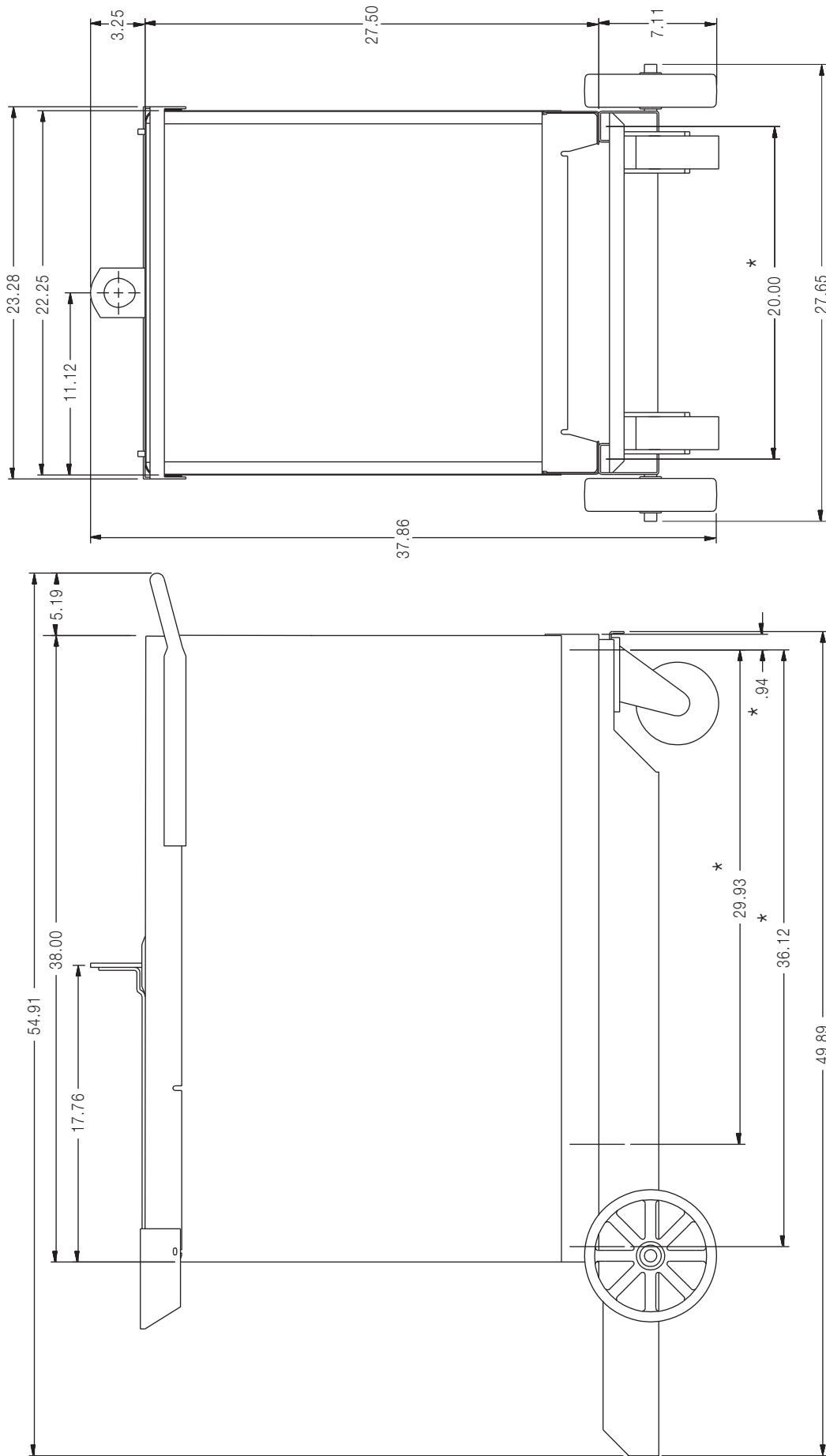

* LOCATION OF BASE MOUNTING HOLES

6-18-98C

M15200-3

IDEALARC® DC-600



NOTES

IDEALARC® DC-600



			
WARNING	<ul style="list-style-type: none"> ● Do not touch electrically live parts or electrode with skin or wet clothing. ● Insulate yourself from work and ground. 	<ul style="list-style-type: none"> ● Keep flammable materials away. 	<ul style="list-style-type: none"> ● Wear eye, ear and body protection.
Spanish AVISO DE PRECAUCION	<ul style="list-style-type: none"> ● No toque las partes o los electrodos bajo carga con la piel o ropa mojada. ● Aíslese del trabajo y de la tierra. 	<ul style="list-style-type: none"> ● Mantenga el material combustible fuera del área de trabajo. 	<ul style="list-style-type: none"> ● Protéjase los ojos, los oídos y el cuerpo.
French ATTENTION	<ul style="list-style-type: none"> ● Ne laissez ni la peau ni des vêtements mouillés entrer en contact avec des pièces sous tension. ● Isolez-vous du travail et de la terre. 	<ul style="list-style-type: none"> ● Gardez à l'écart de tout matériel inflammable. 	<ul style="list-style-type: none"> ● Protégez vos yeux, vos oreilles et votre corps.
German WARNUNG	<ul style="list-style-type: none"> ● Berühren Sie keine stromführenden Teile oder Elektroden mit Ihrem Körper oder feuchter Kleidung! ● Isolieren Sie sich von den Elektroden und dem Erdboden! 	<ul style="list-style-type: none"> ● Entfernen Sie brennbares Material! 	<ul style="list-style-type: none"> ● Tragen Sie Augen-, Ohren- und Körperschutz!
Portuguese ATENÇÃO	<ul style="list-style-type: none"> ● Não toque partes elétricas e electrodos com a pele ou roupa molhada. ● Isole-se da peça e terra. 	<ul style="list-style-type: none"> ● Mantenha inflamáveis bem guardados. 	<ul style="list-style-type: none"> ● Use proteção para a vista, ouvido e corpo.
Japanese 注意事項	<ul style="list-style-type: none"> ● 通電中の電気部品、又は溶材にヒブやぬれた布で触れないこと。 ● 施工物やアースから身体が絶縁されている様にして下さい。 	<ul style="list-style-type: none"> ● 燃えやすいものの側での溶接作業は絶対にしてはなりません。 	<ul style="list-style-type: none"> ● 目、耳及び身体に保護具をして下さい。
Chinese 警告	<ul style="list-style-type: none"> ● 皮肤或湿衣物切勿接触带电部件及焊缝。 ● 使你自己与地面和工作件绝缘。 	<ul style="list-style-type: none"> ● 把一切易燃物品移离工作场所。 	<ul style="list-style-type: none"> ● 佩戴眼、耳及身体劳动保护用具。
Korean 위험	<ul style="list-style-type: none"> ● 전도체나 용접봉을 젖은 헝겊 또는 피부로 절대 접촉치 마십시오. ● 모재와 접지를 접촉치 마십시오. 	<ul style="list-style-type: none"> ● 인화성 물질을 접근시키지 마십시오. 	<ul style="list-style-type: none"> ● 눈, 귀와 몸에 보호장구를 착용하십시오.
Arabic تحذير	<ul style="list-style-type: none"> ● لا تلمس الاجزاء التي يسري فيها التيار الكهربائي أو الألكترود بجند الجسم أو بالملابس المبللة بالماء. ● ضع عازلا على جسمك خلال العمل. 	<ul style="list-style-type: none"> ● ضع المواد القابلة للاشتعال في مكان بعيد. 	<ul style="list-style-type: none"> ● ضع أدوات وملابس واقية على عينيك وأذنيك وجسمك.

READ AND UNDERSTAND THE MANUFACTURER'S INSTRUCTION FOR THIS EQUIPMENT AND THE CONSUMABLES TO BE USED AND FOLLOW YOUR EMPLOYER'S SAFETY PRACTICES.

SE RECOMIENDA LEER Y ENTENDER LAS INSTRUCCIONES DEL FABRICANTE PARA EL USO DE ESTE EQUIPO Y LOS CONSUMIBLES QUE VA A UTILIZAR, SIGA LAS MEDIDAS DE SEGURIDAD DE SU SUPERVISOR.

LISEZ ET COMPRENEZ LES INSTRUCTIONS DU FABRICANT EN CE QUI REGARDE CET EQUIPMENT ET LES PRODUITS A ETRE EMPLOYES ET SUIVEZ LES PROCEDURES DE SECURITE DE VOTRE EMPLOYEUR.

LESEN SIE UND BEFOLGEN SIE DIE BETRIEBSANLEITUNG DER ANLAGE UND DEN ELEKTRODENEINSATZ DES HERSTELLERS. DIE UNFALLVERHÜTUNGSVORSCHRIFTEN DES ARBEITGEBERS SIND EBENFALLS ZU BEACHTEN.

			
<ul style="list-style-type: none"> ● Keep your head out of fumes. ● Use ventilation or exhaust to remove fumes from breathing zone. 	<ul style="list-style-type: none"> ● Turn power off before servicing. 	<ul style="list-style-type: none"> ● Do not operate with panel open or guards off. 	WARNING
<ul style="list-style-type: none"> ● Los humos fuera de la zona de respiración. ● Mantenga la cabeza fuera de los humos. Utilice ventilación o aspiración para gases. 	<ul style="list-style-type: none"> ● Desconectar el cable de alimentación de poder de la máquina antes de iniciar cualquier servicio. 	<ul style="list-style-type: none"> ● No operar con panel abierto o guardas quitadas. 	Spanish AVISO DE PRECAUCION
<ul style="list-style-type: none"> ● Gardez la tête à l'écart des fumées. ● Utilisez un ventilateur ou un aspirateur pour ôter les fumées des zones de travail. 	<ul style="list-style-type: none"> ● Débranchez le courant avant l'entretien. 	<ul style="list-style-type: none"> ● N'opérez pas avec les panneaux ouverts ou avec les dispositifs de protection enlevés. 	French ATTENTION
<ul style="list-style-type: none"> ● Vermeiden Sie das Einatmen von Schweißrauch! ● Sorgen Sie für gute Be- und Entlüftung des Arbeitsplatzes! 	<ul style="list-style-type: none"> ● Strom vor Wartungsarbeiten abschalten! (Netzstrom völlig öffnen; Maschine anhalten!) 	<ul style="list-style-type: none"> ● Anlage nie ohne Schutzgehäuse oder Innenschutzverkleidung in Betrieb setzen! 	German WARNUNG
<ul style="list-style-type: none"> ● Mantenha seu rosto da fumaça. ● Use ventilação e exaustão para remover fumo da zona respiratória. 	<ul style="list-style-type: none"> ● Não opere com as tampas removidas. ● Desligue a corrente antes de fazer serviço. ● Não toque as partes elétricas nuas. 	<ul style="list-style-type: none"> ● Mantenha-se afastado das partes moventes. ● Não opere com os painéis abertos ou guardas removidas. 	Portuguese ATENÇÃO
<ul style="list-style-type: none"> ● ヒュームから頭を離すようにして下さい。 ● 換気や排煙に十分留意して下さい。 	<ul style="list-style-type: none"> ● メンテナンス・サービスに取りかかる際には、まず電源スイッチを必ず切ってください。 	<ul style="list-style-type: none"> ● パネルやカバーを取り外したまま機械操作をしないで下さい。 	Japanese 注意事項
<ul style="list-style-type: none"> ● 頭部遠離煙霧。 ● 在呼吸區使用通風或排風器除煙。 	<ul style="list-style-type: none"> ● 維修前切斷電源。 	<ul style="list-style-type: none"> ● 儀表板打開或沒有安全罩時不準作業。 	Chinese 警告
<ul style="list-style-type: none"> ● 얼굴로부터 용접가스를 멀리하십시오. ● 호흡지역으로부터 용접가스를 제거하기 위해 가스제거기나 통풍기를 사용하십시오. 	<ul style="list-style-type: none"> ● 보수전에 전원을 차단하십시오. 	<ul style="list-style-type: none"> ● 판넬이 열린 상태로 작동치 마십시오. 	Korean 위험
<ul style="list-style-type: none"> ● ابعء رأسك بعيداً عن الدخان. ● استعمل التهوية أو جهاز ضغط الدخان للخارج لكي تبعد الدخان عن المنطقة التي تتنفس فيها. 	<ul style="list-style-type: none"> ● اقطع التيار الكهربائي قبل القيام بأية صيانة. 	<ul style="list-style-type: none"> ● لا تشغيل هذا الجهاز اذا كانت الاغطية الحديدية الواقية ليست عليه. 	Arabic تحذير

LEIA E COMPREENDA AS INSTRUÇÕES DO FABRICANTE PARA ESTE EQUIPAMENTO E AS PARTES DE USO, E SIGA AS PRÁTICAS DE SEGURANÇA DO EMPREGADOR.

使う機械や溶材のメーカーの指示書をよく読み、まず理解して下さい。そして貴社の安全規定に従って下さい。

請詳細閱讀並理解製造廠提供的說明以及應該使用的銀焊材料，並請遵守貴方的有閣勞動保護規定。

이 제품에 동봉된 작업지침서를 숙지하시고 귀사의 작업자 안전수칙을 준수하시기 바랍니다.

اقرأ بتمعن وافهم تعليمات المصنع المنتج لهذه المعدات والمواد قبل استعمالها واتبع تعليمات الوقاية لصاحب العمل.



• World's Leader in Welding and Cutting Products •

• Sales and Service through Subsidiaries and Distributors Worldwide •

Cleveland, Ohio 44117-1199 U.S.A. TEL: 216.481.8100 FAX: 216.486.1751 WEB SITE: www.lincolnelectric.com