



Weldclass

Be Outstanding

Cutforce 43P Cutforce 41PA



OPERATING INSTRUCTIONS

Edition 1.3

IMPORTANT!

To qualify for full 24 month warranty, you must register within 30 days of purchase. See inside for details.

Read these Operating Instructions Completely before attempting to use this machine. Save this manual and keep it handy for quick reference. Pay particular attention to the safety instructions we have provided for your protection. Contact your distributor if you do not fully understand anything in this manual.

Congratulations & thank you for choosing Weldclass!

The Weldforce range from Weldclass provides market leading value, features and durability.

Register Your Warranty Now

To qualify for an extended warranty, you must register within 30 days of purchase.

Full details on warranty period and terms can be found at www.weldclass.com.au/WarrantyInfo

Please register your warranty now by going to:



www.weldclass.com.au/weldforcewarranty

You will need;

- a) A copy of your purchase invoice / receipt.
- b) Your machine serial number which can be found on the technical data plate on the back of the machine, or on the outside of the box that your machine came in.

Satisfaction Guarantee

For full details on our satisfaction guarantee, refer to www.weldclass.com.au/mbg

Highly Recommended Accessory (43P model only):

Dry and clean compressed air is extremely critical for successful plasma cutting. Any humidity (moisture) or particle (dirt/dust) content in the compressed air supply will; increase the likelihood of torch & machine malfunction, accelerate parts consumption and affect cutting capacity/performance.

The air regulator/filter supplied with the CF-45P machine provides the minimum level of filtration. However, we strongly recommend the **WELDCLASS PLATINUM Z-20** high-performance air filter, available as an optional accessory from your Weldclass distributor. This attaches to the inlet of the existing regulator/filter and provides excellent filtration down to 1-micron.

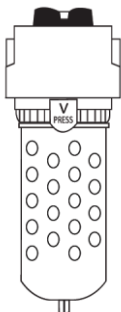

Platinum Z-20 High Performance Air Filter

Part No: WC-06255
Available from your Weldclass distributor

- ✓ Increases torch parts life & reduces consumable costs
- ✓ Improves cutting performance
- ✓ Self-draining
- ✓ Long-life filter cartridge (≤6 months)

1 CONTENTS

- 1 CONTENTS.....3
- 2 BASIC SPECIFICATIONS5
- 3 KNOW YOUR MACHINE6
 - 3.1 Machine Front6
 - 3.2 Machine Rear6
 - 3.3 Control Panel7
 - 3.4 Symbols chart8
- 4 CONTROLS EXPLAINED9
 - 4.1 Amperage Adjustment9
 - 4.2 Setting Air Pressure (43P model only).....9
 - 4.3 Air Filter / Water Separator (43P model only).....10
 - 4.4 Error/Over Temperature Indicator Light10
 - 4.5 Cutting Active Light10
 - 4.6 Compressor Error Light (41PA model only)11
- 5 POWER & COMPRESSED AIR SUPPLY11
 - 5.1 Electrical Connection.....11
 - 5.2 Extension Leads.....11
 - 5.3 Generator Use11
 - 5.3.1 Generator Size11
 - 5.3.2 Generator Quality & Warranty Limitations11
 - 5.3.3 3 Golden Rules of Generator use12
 - 5.4 Compressed Air Requirements (43P model only)12
 - 5.4.1 Air Filtration12
 - 5.4.2 Air Compressor Size / Air Supply12
 - 5.4.3 Air Hose & Fittings.....12
- 6 OPERATING ENVIRONMENT.....12
 - 6.1 Location12
 - 6.2 Ventilation12
- 7 BASIC OPERATION13
 - 7.1 Setup13
 - 7.2 Cutting13
 - 7.3 Travel Speed14
 - 7.4 Piercing the work piece15
 - 7.5 Direction of Cut15
 - 7.6 Reducing Dross for Clean Cuts16
- 8 ACCESSORIES, SPARE PARTS & CIRCUIT DIAGRAMS.....17

8.1	Plasma Torch and Spares:.....	17
8.2	Optional Accessories.....	17
8.3	Plasma Torch Pin Configuration.....	18
8.4	Machine Spare Parts for 43P.....	18
8.5	Machine Spare Parts for 41PA.....	20
8.6	Primary Schematic Circuit Diagram for 43P.....	22
8.7	Primary Schematic Circuit Diagram for 41PA.....	23
9	CARE & MAINTENANCE.....	24
9.1	Keep your Plasma Cutting Machine in Top Condition.....	24
9.2	Storing the Plasma Cutter.....	24
10	GENERAL GUIDE TO PLASMA CUTTING.....	25
10.1	How does Plasma Cutting work?.....	25
10.2	Duty Cycle Rating.....	25
10.3	Pilot Arc System.....	25
10.4	Plasma Torch Parts Wear & Replacement.....	26
11	TROUBLESHOOTING.....	27
12	KNOWLEDGE & RESOURCES.....	29
13	SAFETY.....	29
13.1	Store and Retain this Manual.....	29
13.2	Important Safety Information.....	29
13.3	General Safety Warnings.....	29
13.4	Plasma Cutting Safety Instructions & Warnings.....	31
13.4.1	Personal Safety.....	32
13.4.2	Arc Rays can Burn Eyes and Skin.....	32
13.4.3	Noise Can Damage Hearing.....	32
13.4.4	Work Environment Safety.....	33
13.4.5	Electricity Can Kill.....	33
13.4.6	Fumes And Gases.....	34
13.4.7	Fire & Explosive Risks.....	34
13.4.8	Sparks & Hot Metal.....	35
14	WARRANTY.....	35
14.1.1	Warranty Link.....	35

2 BASIC SPECIFICATIONS



Description	CutForce 43P	CutForce 43P
Part Number	WC-43P	WC-43P
Dimensions of Power Source (L x W x H)	420 x 182 x 292mm	470 x 260 x 378mm
Weight of Power Source	7kg	17kg
Standard	AS 60974.1	AS 60974.1
Power Supply	240V +/- 15% 50hz Single Phase	240V +/- 15% 50hz Single Phase
Factory Fitting Supply Plug Rating	15A	15A
Effective Input Current (I_{1eff})	14A	15A
Maximum Input Current (I_{1max})	25A	27.5A
Earth Terminal	Dinse™ style 10-25	Dinse™ style 10-25
Protection Class	IP23	IP23
Cutting Current Output	20 – 40A	10 – 40A
Cutting Voltage Output	84 – 96V	84 – 96V
Duty Cycle	35A @ 30% 25A @ 60%	35A @ 30% 25A @ 60%
Nominal Open Circuit Voltage	313V	313V

Table 1

For full machine specifications, refer to technical data plate on back of machine – or go to:
www.Weldclass.com.au/WC-43P / www.Weldclass.com.au/WC-41PA

3 KNOW YOUR MACHINE

3.1 Machine Front

1. Plasma Torch Central Connector (Negative (-))
2. Earth Lead Connection Socket (Positive (+))
3. Control panel

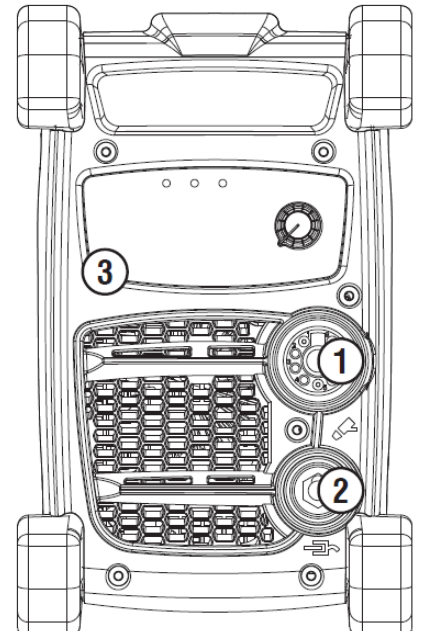
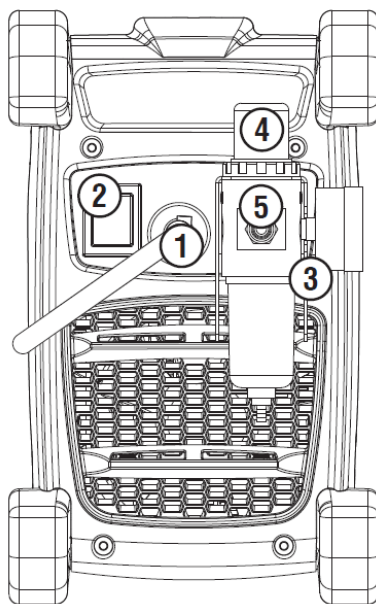

Figure 1

3.2 Machine Rear

1. 240V AC Mains Power Input Lead
2. Mains Power Switch
3. Air Regulator Gauge
4. Air Regulator Adjustment Knob
5. Compressed Air Inlet Connection



43P

Figure 2

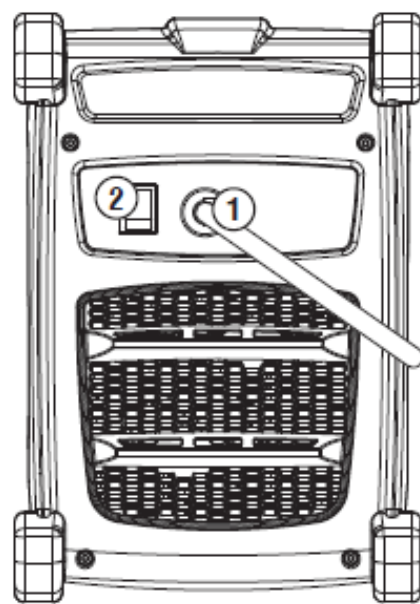

41PA

3.3 Control Panel

- 1. Power Indicator Light
- 2. Cutting Active Indicator Light
- 3. Error/Over Temperature Indicator Light
- 4. Amperage Knob
- 5. Compressor Error Indicator Light

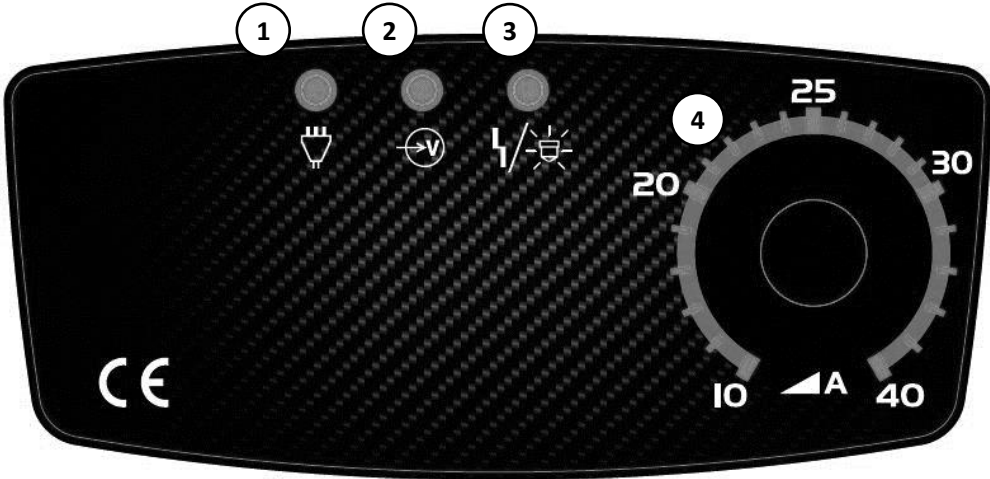











43P



41PA

Figure 3

3.4 Symbols chart

	Power On
	Power Off
	Power On Indication
	Fault Indication
	Caution / Hazard
	Read Instruction Manual
	Torch/Consumable Error
	Output (Cutting Voltage) Active
	Single phase Inverter power source DC
	Plasma Cutting Function









	Power Supply Connection
	Single Phase
	Direct Current (DC)
	Negative
	Positive
	Hertz (cycles/sec)
	Duty Cycle
	Amperage (Current)
	Voltage

Table 2

4 CONTROLS EXPLAINED

4.1 Amperage Adjustment

1. Rotate Amperage Knob to desired amperage setting.

NOTE: In most applications maximum amperage (40A) will work best.

On very thin material or delicate applications you may wish to turn the amperage down.

Turning the amperage down (to 30-35A) also reduces power consumption & increases duty cycle, which can be beneficial when cutting heavier materials &/or doing longer cuts.



Figure 4

4.2 Setting Air Pressure (43P model only)

Correct air pressure is critical for plasma cutting. Incorrect air pressure will cause poor cut quality, lack of cutting power, damage to the plasma torch and consumables and potentially damage the power source. Optimum air pressure is 515kpa / 0.5 MPa / 75psi. Air pressure should be set with the air flowing through the torch, as the pressure with the air flowing will normally be less than static pressure, due to flow losses through the torch system.

1. Trigger the torch briefly to begin air flow through the torch.
2. Lift the Air Regulator Adjustment Knob up to unlock it
3. Rotate Air Regulator Adjustment Knob to adjust air pressure whilst reading the air pressure on the Air Regulator Gauge.
4. Once correct Air Pressure is set push the Air Regulator Adjustment Knob down to lock it in position.

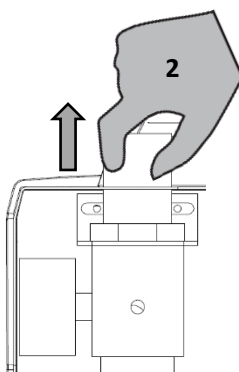

Figure 5

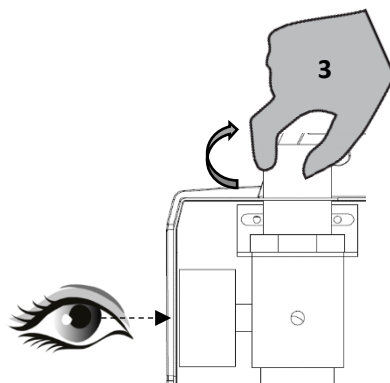

Figure 6

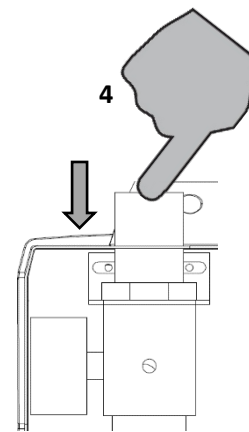

Figure 7

4.3 Air Filter / Water Separator (43P model only)

As with correct air pressure, clean, dry air is also critical for plasma cutting machine performance and reliability. Moist or dirty air will significantly reduce cut quality and consumable life.

The Cutforce 43P is supplied with a basic air filtration/moisture separator to assist with providing suitable air supply. The moisture separator is self-draining, the Air Filter Moisture Drain Tube exits out the bottom of the clear Air Filter Bowl. It is normal to see moisture coming from this tube periodically. If excessive amounts of water or oil are being produced in the bowl and drain line, the compressed air supply should be checked for issues.

4.4 Error/Over Temperature Indicator Light

Error/Over Temperature Indicator Light illuminates yellow to indicate a warning or error. This can be for a number of causes as follows.

Solid Yellow:

- Duty cycle is exceeded and thermal protection is activated. When thermal protection is activated, plasma cutting output will be disabled until machines cools sufficiently and the error light goes out.
- Input power supply error – the power supply voltage to the machine is either too high or too low. Once power supply returns within an acceptable voltage range the error light will go out.

Flashing Yellow:

- Air pressure is too low or there is no air in the torch.
- Worn consumables. Replace worn torch consumables.
- Torch consumables are installed incorrectly or some consumables are missing/not installed.
- Faulty torch

The flashing light will turn off on the next cut after the cause is resolved.



Figure 8

4.5 Cutting Active Light

The Cutting Active Light illuminates Yellow when the cutting power circuit is activated.

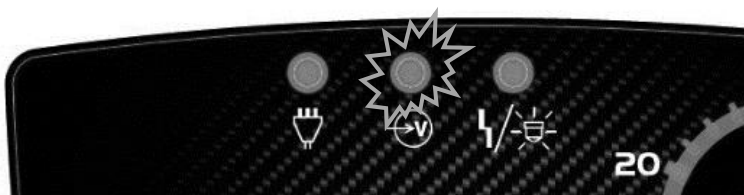
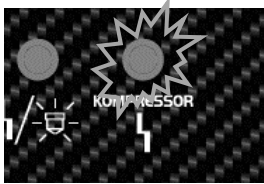

Figure 9

4.6 Compressor Error Light (41PA model only)

The Compressor Error Light illuminates Red when there is a fault with the built-in compressor. This can mean that the compressor has over-heated and needs to be allowed to cool. If the error light does not turn off when the machine has been allowed to cool then this likelihood is that it is a more serious fault which possibly requires the compressor to be replaced. In this case please contact your Weldclass distributor to arrange inspection and repair.



5 POWER & COMPRESSED AIR SUPPLY

5.1 Electrical Connection

The Cutforce 43P and 41PA are designed to operate on a 15A 240V AC power supply.

5.2 Extension Leads

If an extension cord must be used, it should be minimum cable core size 2.0mm² for length of up to 10m, or minimum 2.5mm² for lengths over 10m.

Using extension leads of over 20m are not recommended.

5.3 Generator Use

This machine is designed with generator use in mind and incorporates wide voltage tolerance and intelligent voltage sensing technology to provide maximum protection from power fluctuations that can occur with motor generators.

5.3.1 Generator Size

Generator size should be not less than 8kva. An 8kVa generator will not provide enough power to enable full output and duty cycle of this plasma cutter. However, it should provide sufficient power for light cutting and short runs.

Turning the amperage down to 30 or 35A will significantly reduce power consumption with little impact on cutting performance so this is recommended if power supply is lower/limited.

To enable full output and duty cycle of this plasma cutter a recommended generator size is minimum 10kVa.

5.3.2 Generator Quality & Warranty Limitations

Avoid using poor, low quality generators as these have the greatest risk of power spikes etc. A suitable quality generator should have a THD (total harmonic distortion) rating of no more than 6%. Most reputable generator suppliers will be able to specify the THD ratings on their product.

Any damage caused by poor quality generator power supply or incorrect use is not covered under warranty.

5.3.3 3 Golden Rules of Generator use

When running an inverter plasma cutter off a generator there are 3 **VERY IMPORTANT** Golden Rules that **MUST** be followed:

1. Do **NOT** plug plasma cutter into generator until **AFTER** generator has been started up and is running smoothly
2. **UNPLUG** plasma cutter from generator **BEFORE** shutting generator down/turning generator off
3. **NEVER** let your generator run out of fuel whilst the plasma cutter is plugged in.

Following these Golden Rules will significantly reduce the risk of any damage resulting from generator power supply.

5.4 Compressed Air Requirements (43P model only)

A reliable and consistent supply of clean dry compressed air is essential for proper operation.

5.4.1 Air Filtration

Although the machine contains its own internal air supply filtration system it is recommended the compressed air supply should have external filtration in the line feeding the machine, both a standard water trap (sintered bronze filter) and also a coalescing filter (for oil in air).

The air must be dry and free of oil and moisture (normally a symptom of older, worn out compressors).

5.4.2 Air Compressor Size / Air Supply

The air requirement is a minimum of 120 L/min (4.5cfm) Free Air Delivery (FAD) at 75psi pressure. This normally means the compressor must be a belt drive model or if a direct drive it must have a motor power of 2.5HP or greater.

5.4.3 Air Hose & Fittings

The air hose must also be of sufficient size (3/8" / 10mm minimum) to supply the machine.

The machine is supplied standard with a Nitto-style male air fitting. If you don't use Nitto fittings in your workshop you will need to replace this fitting.

6 OPERATING ENVIRONMENT

6.1 Location

The machine has electrical components and control circuit boards which may be damaged by excessive moisture, dust and dirt, so a clean and dry operating environment is important for reliable product life.

The enclosure design of this power source meets the requirements of IP23S as outlined in AS60529. This provides adequate protection against solid objects (greater than 12mm), and direct protection from vertical drops. Under no circumstances should the unit be operated or connected in a micro environment that will exceed the stated conditions. For further information please refer to AS 60529.

6.2 Ventilation

Adequate ventilation is required to provide proper cooling for the machine. Ensure that the machine is placed on a stable level surface where clean cool air can easily flow through the unit.

7 BASIC OPERATION

7.1 Setup

1. Connect the earth cable quick connector to the Earth Connection Socket.
2. Connect the earth clamp to the work piece. Contact with the work piece must be firm contact with clean, bare metal, with no corrosion, paint or scale at the contact point.
3. Connect the plasma torch to the Plasma Torch Central Connector ensuring the collar is done up firmly.

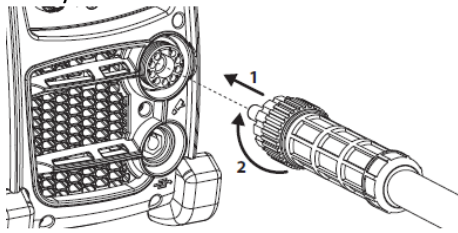

4. Connect the machine to suitable mains power using the Mains Power Input Lead.
5. Switch the Mains Power Switch to 'on' (I) to power up the machine.
6. Connect the compressed air supply to the Compressed Air Inlet Connection (43P model only)
7. Set the air pressure (Refer to: 4.2- Setting Air Pressure) (43P model only)
8. Set the required Amperage (Refer to: 4.1 - Amperage Adjustment)
9. You are now ready to cut!

7.2 Cutting

1. Hold the Torch Tip on the work piece, so the centre of the Torch Tip is aligned to the edge of the material.
2. Pull the torch Trigger (compressed air flow will start and the electronic ignition arc should energize)
3. As the ignition arc jumps to the work piece, the main plasma arc will ignite and start cutting.
4. After starting the cut, the Torch can be dragged along the work piece.
5. When ending a cut, the torch Trigger should be released and lifted off the work piece just before the end of the cut to minimize double-arcing which can damage the tip. This is to prevent the ignition arc from reigniting after cutting arc extinguishes.
6. Compressed air will continue to flow through the torch for several seconds after the cutting stops. In this post-flow mode, the arc can be restarted immediately by depressing the torch switch.

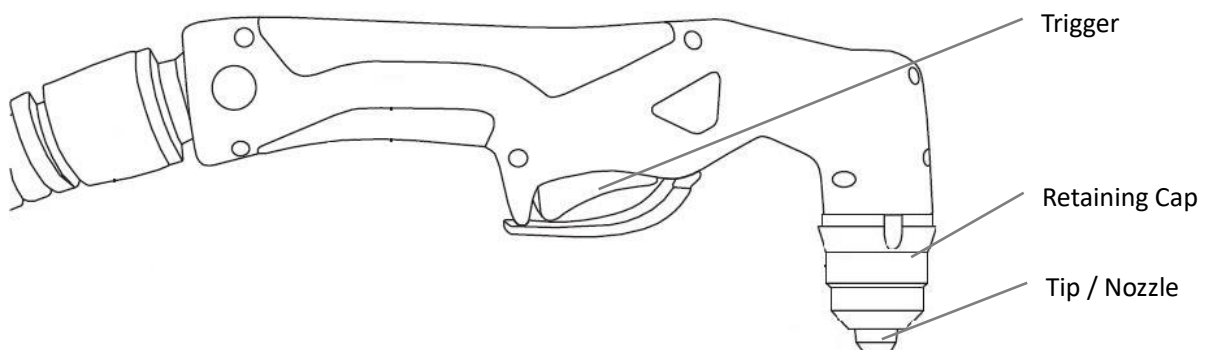

Figure 10

7.3 Travel Speed

The speed at which the torch moves will significantly influence the quality of the cut.

Correct Speed – When travelling at the correct speed the kerf out the bottom of the material should either be perpendicular or lag *behind* at an angle up to 15°. The result should be a clean cut with limited dross.

Too Fast – this will either not cut right through the material or the kerf will lag *behind* at an angle greater than 15°.

Often this will create excess ‘top dross’ on the top of the material. Any dross on the bottom of the cut will likely be ‘High-speed dross’ which is very hard and difficult to remove.

Too Slow – the kerf will lean *forwards* out the bottom of the plate. This will also create a lot of ‘low-speed dross’ on the bottom of the cut. Low-speed dross is soft and easy to chip off.

If speed is excessively slow the arc may lose contact with the material and extinguish or drop out temporarily.

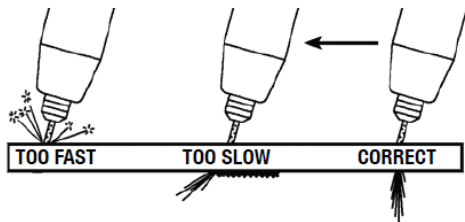

Figure 11

Cutting Speed Guide		
Material	Thickness (mm)	Cutting Speed (mm/min)
Carbon/Mild Steel	2.0	5400
	3.0	2200
	4.0	1300
	5.0	780
	6.0	500
	8.0	180
Stainless Steel	2.0	3600
	3.0	1900
	4.0	1100
	5.0	600
	6.0	300
	8.0	100
Aluminium	2.0	6000
	3.0	2600
	4.0	1600
	5.0	1000
	6.0	600
	8.0	200

Table 3

Note: The speeds given here are typical for best quality cuts. Your actual speeds may vary depending on material composition, surface condition, operator technique, etc.

Air cutting typically produces a rough face on stainless steel and aluminium.

7.4 Piercing the work piece

Where you are unable to start cutting from the edge of the material you may need to pierce through the material.

The torch should be angled at about 30° when starting to pierce, and then straightened as the arc penetrates the material. This will blow the molten material away from the torch so it is not forced directly back at the tip which will cause excessive wear or damage.

It is advisable when piercing thicker materials to drill a small pilot/starting hole in the work piece which makes it a lot easier and gives increased tip life.

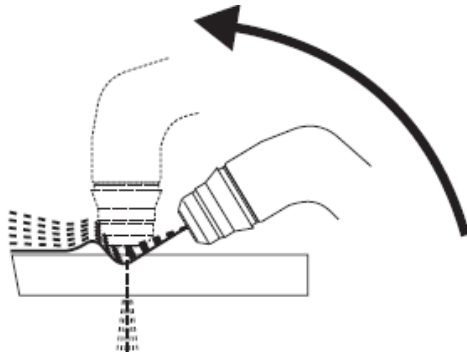

7.5 Direction of Cut

The plasma gas stream swirls as it leaves the torch to maintain a smooth column of gas. This swirl effect results in one side of a cut being squarer than the other.

Viewed along the direction of travel, the right side of the cut is more square than the left.

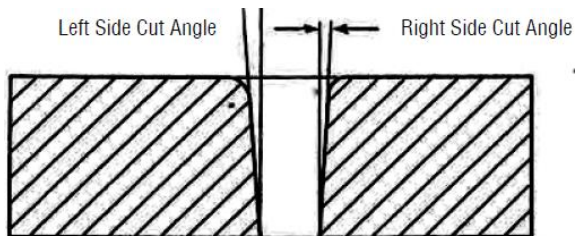

Figure 12

To make a square-edged cut along an inside diameter of a circle, the torch should move counter clockwise around the circle. To keep the square edge along an outside diameter cut, the torch should travel in a clockwise direction.

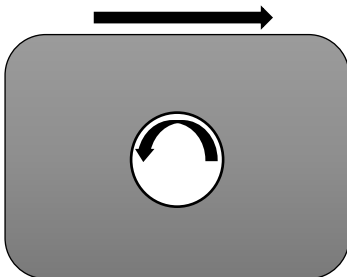

Figure 13

7.6 Reducing Dross for Clean Cuts

Dross (slag) is the excess material that spatters and builds up on the underside of the work-piece as you cut. Dross occurs when the operating procedure and technique is less than optimal. It will require practice and experience to obtain cuts without dross. Although less than optimal cuts will contain dross, it is relatively easy to remove by breaking it off using pliers or chipping off with a chisel or scraping or grinding the finished cut as needed and is generally only a minor inconvenience.

A combination of factors contributes to the build-up of dross. They include; material type, material thickness, amperage used for the cut, speed of the torch across the work-piece, condition of the torch tip, input line voltage, air pressure, etc. Generally there is an inversely proportional relationship between output current and speed of cut. Do not use more output current than is necessary and adjust speed of cut toward minimizing dross build-up on underside of cut. Experiment with adjusting current and speed to minimize dross.

When dross is present on carbon steel, it is commonly referred to as either 'high speed', 'low speed', or 'top dross'.

'Top dross' is present on top of the plate and is normally caused by too great a torch to plate distance or too fast travel speed. It is normally very easy to remove and can often be wiped off with a welding glove.

'Low speed dross' is normally present on the bottom edge of the plate. It can vary from a light to heavy bead, but does not adhere tightly to the cut edge, and can be easily scraped off.

'High speed dross' usually forms a narrow bead along the bottom of the cut edge and is very difficult to remove. Usually it will need to be removed by grinding. When cutting troublesome steel, it is sometimes useful to reduce the cutting speed to produce 'low speed dross'. Any resultant clean up can then be accomplished by scraping, not grinding.

8 ACCESSORIES, SPARE PARTS & CIRCUIT DIAGRAMS

8.1 Plasma Torch and Spares:

The Plasma Torch supplied with the Cutforce 43P and 41PA is a Weldclass XTP-60 model.

To view parts for this torch, see below table.

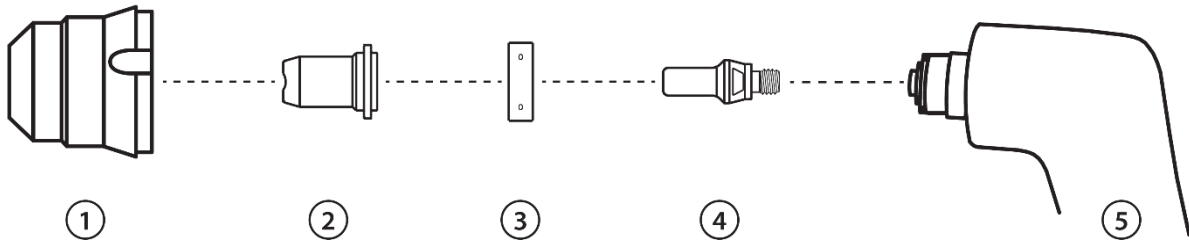

Figure 14

Torch Parts		
Ref.	Part No.	Description
1	WC-06032 *	Retaining Cap (6 hole) suit 43P
	WC-06458 *	Retaining Cap (4 hole) suit 41PA
2	WC-06031	Swirl Ring
3	WC-06029	Tip/Nozzle 30-40A 0.9mm Pk5
4	WC-06028	Electrode Pk5
5	WC-06240	Torch Head

Table 4

*** IMPORTANT!**

41PA must use the WC-06458 Retaining Cap which has 4 air holes.

(43P should use the WC-06032 Retaining Cap which has 6 air holes.)

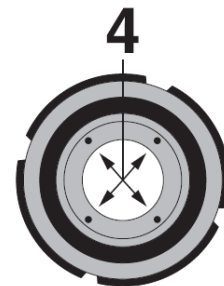

8.2 Optional Accessories

Optional Accessories	
Part No.	Description
WC-06235	Trolley
WC-01775	Welding Gloves

Table 5

8.3 Plasma Torch Pin Configuration

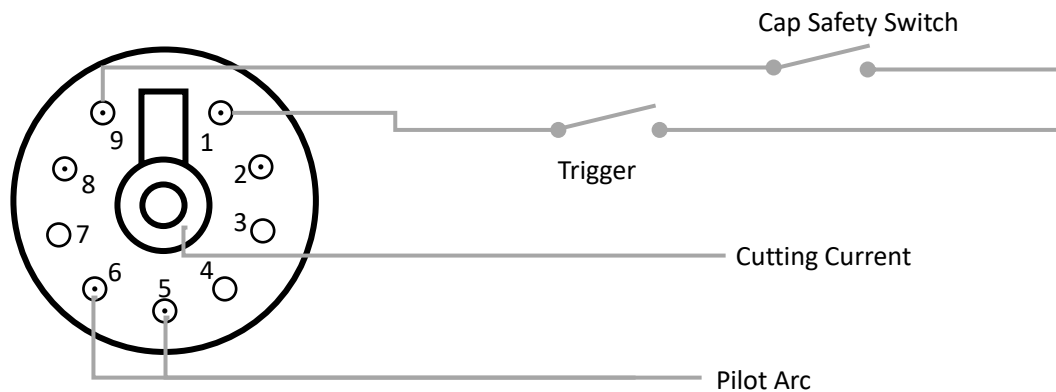

8.4 Machine Spare Parts for 43P

For machine parts, go to www.weldclass.com.au/machines or contact your Weldclass distributor.

Ref.	Description
1	Thermostat
2	Solenoid Valve
3	Air Pressure Regulator
4	Earth Lead + Dinse
5	Mains Power Cable
6	Cooling Fan
7	Earth Clamp
8	Torch Connection Socket
9	Plasma Torch
10	Snap-in Capacitor Kit
11	IGBT + Diode Kit
12	Power PCB kit
13	Front panel PCB Kit
14	Metal Panel Kit
15	Diodes Kit
16	Control PCB kit
17	Power Supply Components Kit
18	Aux Components Kit
19	Power Switch
20	Dinse Socket
21	Potentiometer Kit
22	Plastic Panel Kit

Table 6

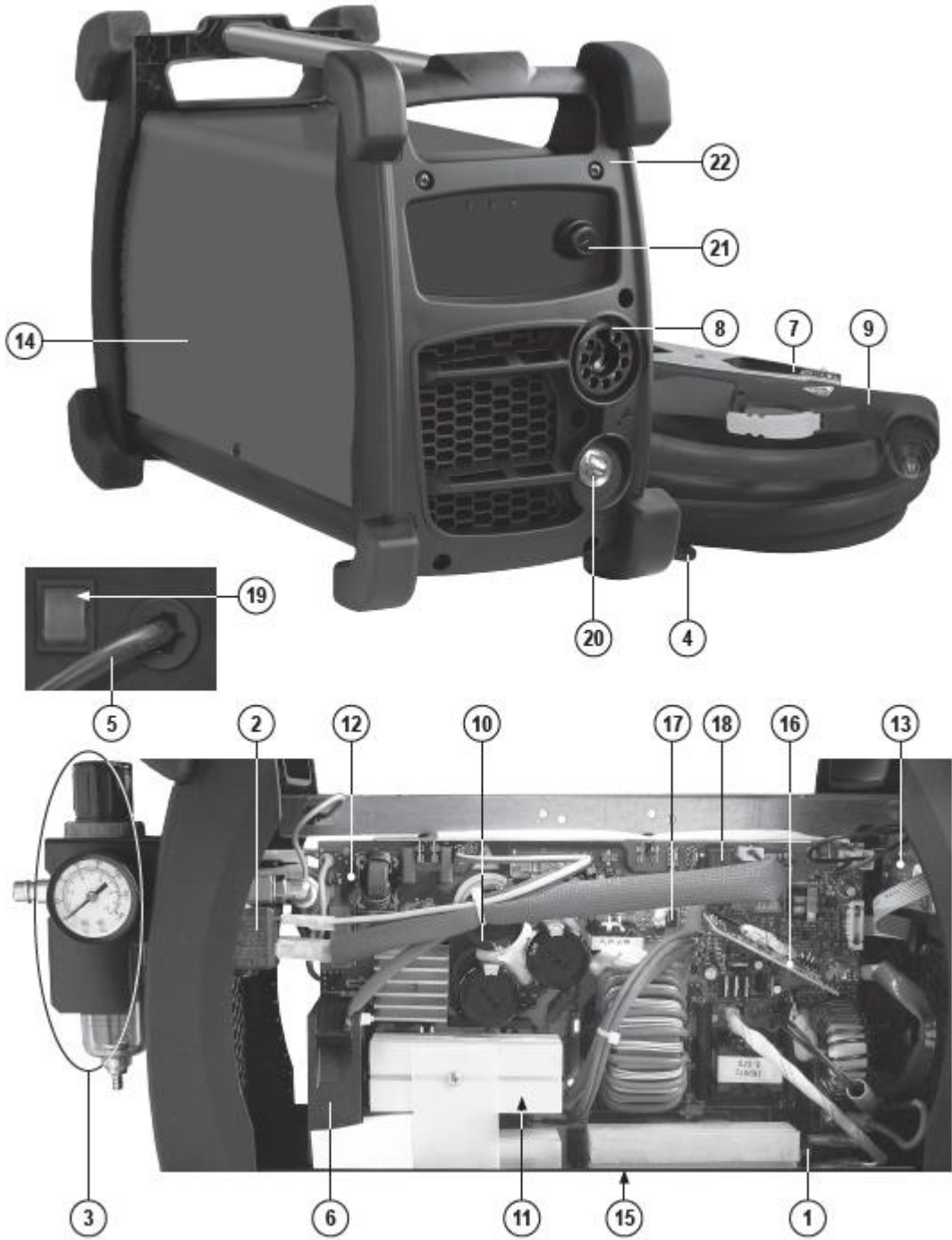

Figure 15

8.5 Machine Spare Parts for 41PA

For machine parts, go to www.weldclass.com.au/machines or contact your Weldclass distributor.

Ref.	Description
1	Earth Lead + Dinse
2	Mains Power Cable
3	Cooling Fan
4	Cooling Fan
5	Earth Clamp
6	Torch Connection Socket
7	Plasma Torch
8	Compressor Kit
9	Power PCB kit
10	Snap-in Capacitor Kit
11	IGBT + Diode Kit
12	Diodes Kit
13	Control PCB kit
14	Power Supply Components Kit
15	Aux Components Kit
16	Metal Case
17	Plastic Panel Kit
18	Power Switch
19	Potentiometer Kit
20	Front Control Panel Kit
21	Dinse Connector

Table 7

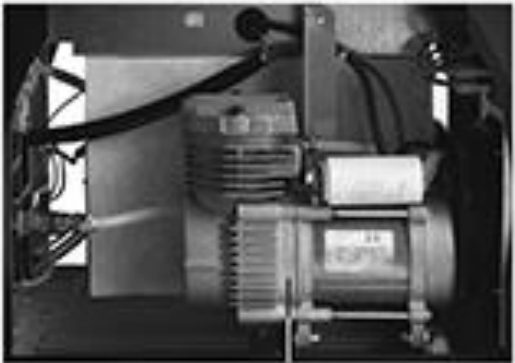
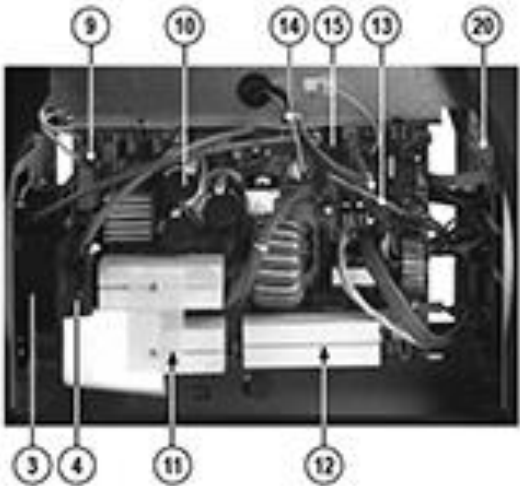

8.6 Primary Schematic Circuit Diagram for 43P

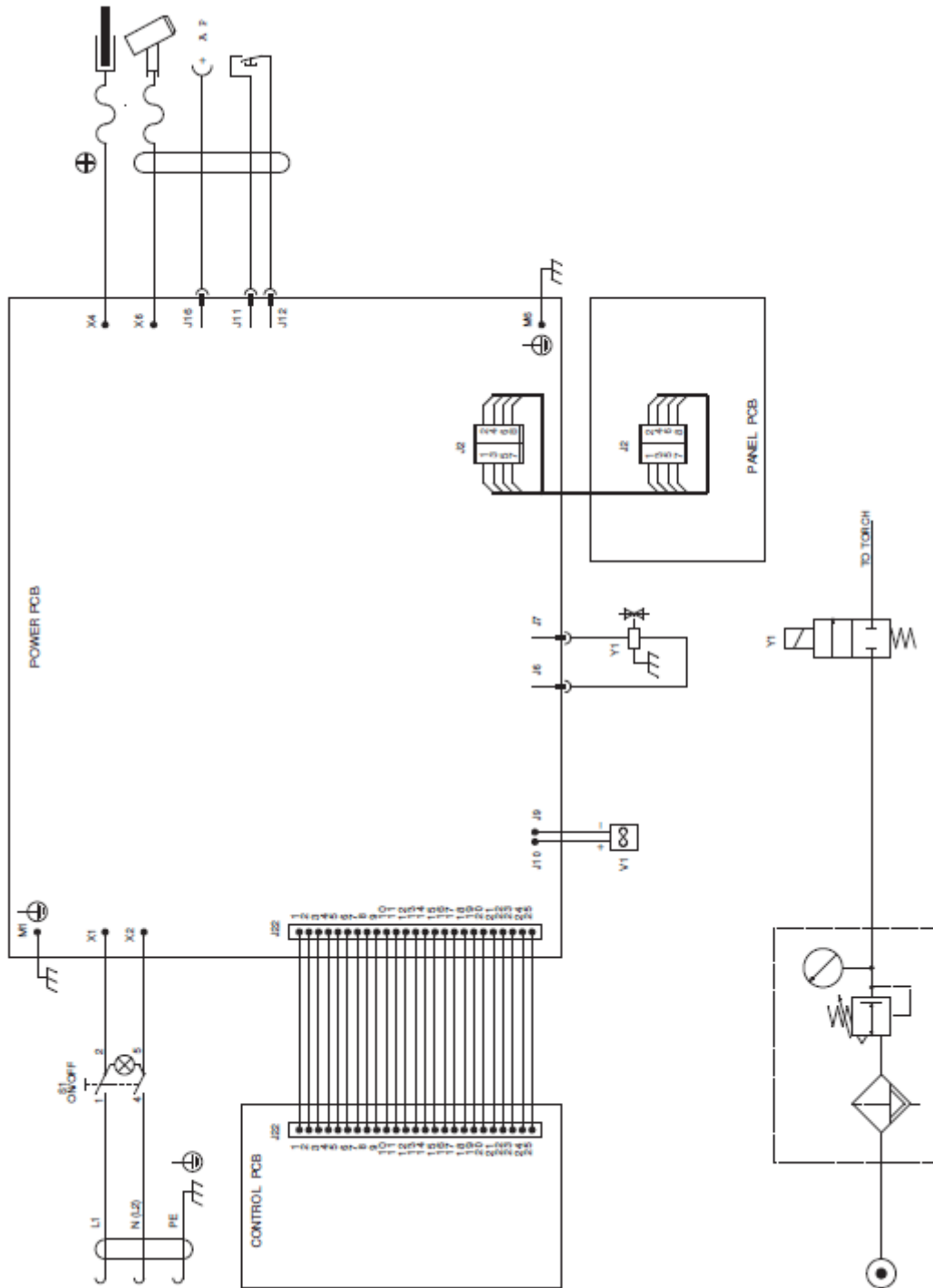

Figure 16

8.7 Primary Schematic Circuit Diagram for 41PA

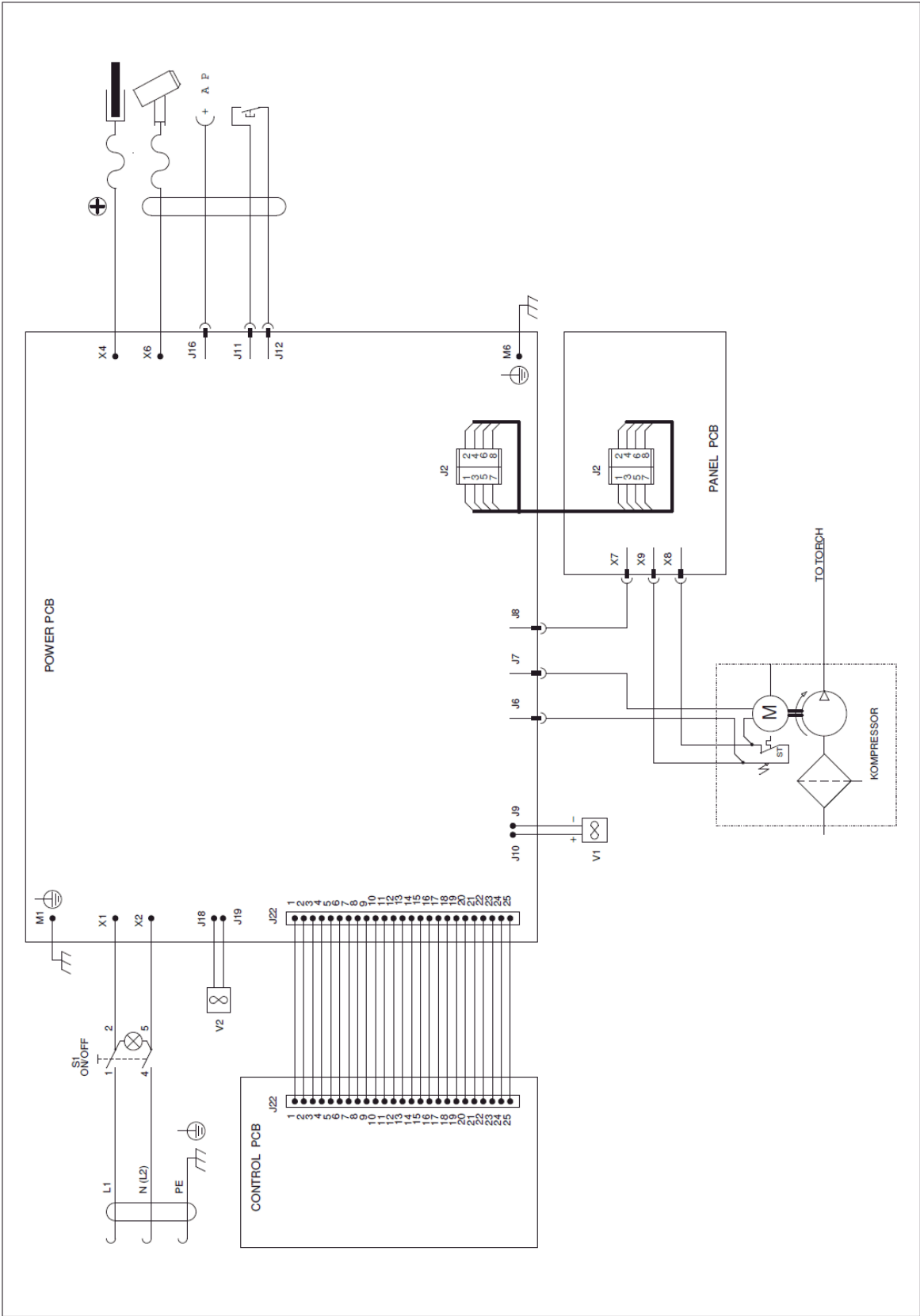

Figure 17

9 CARE & MAINTENANCE

9.1 Keep your Plasma Cutting Machine in Top Condition

The 43P 41PA do not require any special maintenance, however the user should take care of the machine as follows:

1. Regularly clean the ventilation slots
2. Keep the casing clean
3. Check all cables before use
4. Check electrode holders, work lead/clamps and cutting torches before use
5. Replace worn earth clamps which do not provide a good connection
6. Replace worn torch consumable parts in a timely manner
7. Use a soft cloth or brush to clean electrical components. Do not use liquid cleaning products, water or especially solvents
8. Do not use compressed air to clean electrical components as this can force dirt and dust further into components, causing electrical short circuits
9. Check for damaged parts

WARNING! Before performing cleaning/maintenance, replacing cables/connections, make sure the machine is switched off and disconnected from the power supply.

If damaged, before further use, the machine must be carefully checked by a qualified person to determine that it will operate properly. Check for breakage of parts, mountings and other conditions that may affect its operation.

Have your machine repaired by an expert. An authorised service centre should properly repair a damaged part.

This appliance is manufactured in accordance with relevant safety standards. Only experts must carry out repairing of electrical appliances, otherwise considerable danger for the user may result. Use only genuine replacement parts. Do not use modified or non-genuine parts.

9.2 Storing the Plasma Cutter

When not in use the machine should be stored in the dry, dust-free and frost-free environment.

10 GENERAL GUIDE TO PLASMA CUTTING

10.1 How does Plasma Cutting work?

Plasma technology works by ionising air such that it can conduct electricity. This ionized gas is used to produce an intense arc capable of cutting any electrically conductive material (i.e. all metals).

Plasma cutting only requires electricity and compressed air supply.

In simpler terms, Plasma cutters use an electric arc to cut or gouge metal, similar to Oxy cutting.

10.2 Duty Cycle Rating

CutForce machines are fitted with thermal overload protection which means the machine will cut out when it reaches a certain temperature, to prevent damage to components. The machine will then re-start when it returns to a safe temperature.

Duty cycle is a measure of the percentage of time a machine will operate within a certain time period at a given amperage. For example a duty cycle of 40A @ 30% means that a machine will operate at 40A for 3 minutes in a 10 minute time period. The machine will have to rest for the remaining 7 minutes to enable it to cool down.

The international standard for duty cycle rating is based on an ambient air temperature of 40°C with 50% humidity, over a 10 minute period. In an environment with temperatures exceeding 40°C, the duty cycle will be less than stated. In ambient temperature less than 40°C, duty cycle performance will be higher. There are numerous other factors that can influence actual duty cycle performance.

10.3 Pilot Arc System

This machine uses a pilot arc system to establish the main cutting arc.

A pilot arc system is a circuit where the return is back through the torch head and cable. This means it can create a small arc with some cutting power without making any electrical connection with the main machine earth. This is especially useful for starting cuts on material that does not have a good initial earth connection, such as paint, rust, scale.

Once the pilot arc is established and power is flowing back through the main earth, the pilot arc is switched off and the main arc started. Please note the pilot arc circuit is only designed to operate for short periods of time as an auxiliary starting system, so it has a safety protection that only allows the pilot arc to run for short periods at a time.

In addition to this, this machine has a pilot arc controller system. If the main arc cuts out and the torch remains to be triggered, the pilot arc will reignite. This is useful for cutting discontinuous workpieces like mesh or grids.

10.4 Plasma Torch Parts Wear & Replacement

It is very important to recognise that plasma torch consumables wear as part of normal operation and should be replaced in a timely manner.

Operating a torch with worn consumables will cause poor cutting results and possible damage to the torch and machine itself. Damage caused by untimely replacement of consumables will not be covered by warranty.

Use the following guidelines to determine when consumables should be replaced:

Cutting Tips: The cutting tip has a small calibrated orifice that the plasma passes through. If the orifice becomes partially blocked, deformed or enlarged, the cutting tip should be replaced.

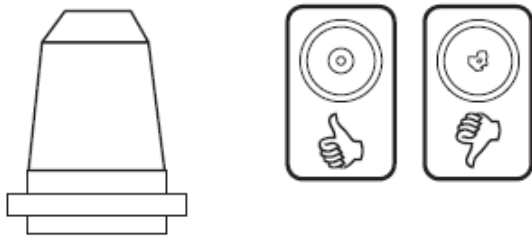

Electrodes: The electrode has a small silver 'hafnium' insert in the end of the tip. This is what generates the plasma ions. Once the hafnium insert is gone or is damaged or worn deeper than 1.5mm the tip must be replaced.

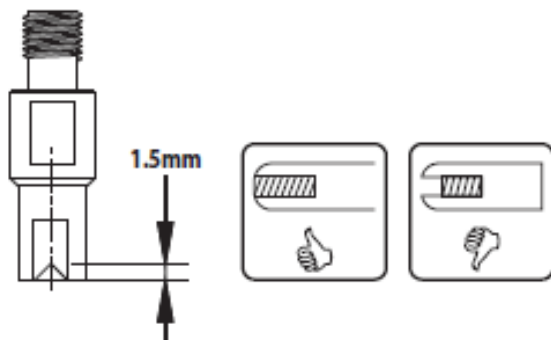

Swirl Ring: This should be replaced if broken, chipped, cracked, worn or badly heat damaged. The small air holes do wear over time. Whilst it is not usually visible with naked eye it can cause the flow & swirl of the air to be disrupted with causes an unstable or deformed arc.

Retaining Cap: This should be replaced if broken, chipped, cracked or badly heat damaged.

Tips and electrodes: These should wear reasonably evenly and it is normal practice to replace them both together. If a new tip is inserted with a worn electrode the tip will wear much more quickly than if the electrode was also replaced at that same time. If tips or electrodes are wearing much faster than the other component it is likely to be caused by one of the following:

- Wet or dirty air supply
- Incorrect air supply
- Poor operator technique
- Damaged torch head

It is also very important to only use genuine Weldclass consumables and parts for the plasma torch. They are engineered to suit the machine and non-genuine items may cause lack of performance, short life span, torch and machine damage and void warranty.

11 TROUBLESHOOTING

Problem	Cause	Solution
Torch will not come on/arc	Power switch OFF	Turn power switch to the ON position
	Air supply is not of sufficient volume or pressure	Check air supply (75-80psi, at least 3.5cfm required)
	Earth clamp not attached	Attach earth clamp to work piece or to steel table with work piece securely clamped to table
Sparks are shooting upward instead of down through the material	Plasma torch is not piecing the material	Increase amperage and/or reduce speed
	Travel speed too fast	Reduce travel speed
	Torch may be too far away from the material	The tip should be torching the material
	Material may be too thick for capacity of plasma	Several passes may be necessary or find some other method to cut the material
Beginning of cut not completely pierced	Possible earth connection problem	Check earth clamp is securely connected to the bare material. Check earth lead is securely plugged into machine. Ensure earth lead is in good condition.
Dross build-up on cuts	Material building up heat	Allow material to cool then continue cutting
	Incorrect speed / technique	Refer to 7.6 - Reducing Dross for Clean Cuts
	Worn torch parts	Replace with new torch parts
Arc stops in middle of cut	Insufficient air supply	Check air supply (75-80psi, at least 3.5cfm required). May have to wait for compressor to build up pressure again.
	Cutting speed is too slow	Increase cut speed until problem solved
	Tip to material distance is too high	Tip should be touching the material
	Worn torch parts	Replace with new torch parts
	Possible earth connection problem	Check earth clamp is securely connected to the bare material. Check earth lead is securely plugged into machine. Ensure earth lead is in good condition.
Insufficient penetration	Cutting speed too fast	Slow down travel speed
	Torch tilted too much	Adjust tilt
	Material may be too thick for capacity of plasma	Several passes may be necessary or find some other method to cut the material

Problem	Cause	Solution
	Worn torch parts	Replace with new torch parts
Arc splutters/flares	Water in the air supply	Install air drier or additional filtration. Drain compressor and air lines.
Torch parts wear quickly	Wet or dirty air supply	Install air drier or additional filtration. Drain compressor and air lines.
	Exceeding unit capability	If material too thick, increase angle to prevent blow back into torch tip
	Excessive ignition Arc use	Do not operate ignition arc for more than 3 seconds – ideally start in contact with edge of material. Do not start ignition arc in mid-air.
	Inadequate air supply, pressure too low	Check air filters, increase air pressure
	Faulty air compressor	Check air compressor operation and make sure supplied air pressure is at least 90psi.
Circuit breaker/fuse trips while operating	Extension cord being used is not heavy duty	Use a heavy duty extension cord (2.5mm ²)
	Extension cord being used is too long	Remove extension cord or use shorter one.
	Cutting beyond the duty cycle capacity of the machine	Turn the amperage down or do shorter cutting runs

12 KNOWLEDGE & RESOURCES

Please refer to Weldclass website www.weldclass.com.au for more information.

13 SAFETY

13.1 Store and Retain this Manual

Retain this manual for the safety warnings and precautions, assembly, operating, inspection, maintenance and cleaning procedures. Write the product's serial number into the NOTES section at the rear, and keep this manual and the receipt in a safe and dry place for future reference.

13.2 Important Safety Information

Failure to follow the warnings and instructions may result in electric shock, fire, serious injury and/or death. Save all warnings and instructions for future reference.

This is the safety alert symbol to alert you to potential personal injury hazards:



Obey all safety messages that follow this symbol to avoid possible injury or death.



DANGER! indicates a hazardous situation which, if not avoided, will result in death or serious injury.



WARNING! indicates a hazardous situation which, if not avoided, could result in death or serious injury.



CAUTION, used with the safety alert symbol, indicates a hazardous situation which, if not avoided, could result in minor or moderate injury.

NOTE, used to address practices not related to personal injury.

CAUTION, without the safety alert symbol, is used to address practices not related to personal injury.

13.3 General Safety Warnings

1. **Maintain labels and nameplates on the plasma cutter.** These carry important information. If unreadable or missing, contact Weldclass for a replacement.
2. **Avoid unintentional starting.** Make sure the plasma cutter is setup correctly and you are prepared to begin work before turning on the machine.
3. **Unplug before performing maintenance.** Always unplug the plasma cutter from its electrical outlet before performing any inspection, maintenance, or cleaning procedures.

4. **Never leave the plasma cutter unattended while plugged into power.** Turn power off before leaving the plasma cutter unattended.
5. **Do not touch live electrical parts.** Wear dry, insulating gloves. Do not touch the torch tip when machine is plugged in. Do not wear wet or damaged gloves. Plasma uses high electric voltage which can cause serious harm or death.
6. **Protect yourself from electric shock.** Do not use the plasma cutter outdoors. Insulate yourself from the work piece and the ground. Use non-flammable, dry insulating material if possible, or use dry rubber mats, dry wood or plywood, or other dry insulating material large enough to cover the area of contact with the work or the ground.
7. **Avoid inhaling fume.** Some fume and dust created by plasma cutting contain chemicals known to cause cancer, birth defects or other harm. Your risk from these exposures varies, depending on how often you do this type of work. To reduce your exposure to these chemicals, work in a well-ventilated area, and work with approved safety equipment, such as dust masks that are specially designed to filter out microscopic particles.
8. **People with pacemakers should consult their physician(s) before using this machine.**



WARNING! *Electromagnetic fields in close proximity to a heart pacemaker could cause interference, or failure of the pacemaker. The use of a Plasma Cutter is NOT RECOMMENDED for pacemaker wearers. Consult your doctor.*

9. **Ensure that the unit is placed on a stable location before use.**



WARNING! *If this unit falls while plugged in, severe injury, electric shock, or fire may result.*

10. **Transportation Methods.** Lift unit with the handle provided, or use a handcart or similar device of adequate capacity. If using a fork lift vehicle, secure the unit to a skid before transporting.



CAUTION! *Disconnect input power conductors from de-energized supply line before moving the machine.*

11. **Exercise good work practices.** The warnings, precautions, and instructions discussed in this instruction manual cannot cover all possible conditions and situations that may occur. It must be understood by the operator that common sense and caution are factors which cannot be built into this product, but must be considered by the operator.
12. **Do not use this machine for pipe thawing.** This machine was not designed for pipe thawing and will be a significant electrical & heat hazard if attempt is made to use for thawing pipe.

13.4 Plasma Cutting Safety Instructions & Warnings



WARNING! Protect yourself and others from possible serious injury or death. Keep children away. Read the operating/Instruction manual before installing, operating or servicing this equipment. Have all installation, operation, maintenance, and repair work performed by qualified people.

If an operator does not strictly observe all safety rules and take precautionary actions, plasma cutting and processes can cause serious injury or death, or damage to other equipment or property.

Safe practices have developed from past experience in the use of welding and cutting. These practices must be learned through study and training before using this equipment. Some of these practices apply to equipment connected to power lines; other practices apply to engine driven equipment. Anyone not having extensive training in welding and cutting practices should not attempt to use these machines.

Safe practices are outlined in the Australian Standard AS 1674.2 entitled: Safety in Welding and European Standard EN60974-1 entitled: Safety in welding and allied processes.



WARNING! Only use safety equipment that has been approved by an appropriate standards agency. Unapproved safety equipment may not provide adequate protection. Eye and breathing protection must be AS/NZS compliant for the specific hazards in the work area.



DANGER! Always wear AS/NZS compliant safety glasses and full face shield fitted with appropriate filter shade number.



CAUTION! Heavy-duty work gloves, non-skid safety shoes and hearing protection used for appropriate conditions will reduce personal injuries.



CAUTION! Have the equipment serviced by a qualified repair person using identical replacement parts. This will ensure that the safety of the power tool is maintained.

13.4.1 Personal Safety



CAUTION! *Keep the work area well lit. Make sure there is adequate space surrounding the work area. Always keep the work area free of obstructions, grease, oil, trash, and other debris. Do not use equipment in areas near flammable chemicals, dust, and vapours. Do not use this product in a damp or wet location.*

1. **Stay alert, watch what you are doing and use common sense when operating equipment.** Do not use a tool while you are tired or under the influence of drugs, alcohol or medication. A moment of distraction when operating equipment may result in serious personal injury.
2. **Do not overreach.** Keep proper footing and balance at all times. This enables better control of the power tool in unexpected situations.

13.4.2 Arc Rays can Burn Eyes and Skin



CAUTION! *Arc rays from the plasma cutting process produce intense heat and strong ultraviolet rays that can burn eyes and skin.*

1. Use a Welding Helmet or Full Face Shield fitted with a proper shade filter (refer AS 60974-1, AS/NZS 1337.1 and AS/NZS 1338.1 Safety Standards) to protect your face and eyes when cutting or watching.
2. Wear approved safety glasses. Side shields are recommended.
3. Use protective screens or barriers to protect others from flash and glare; warn others not to watch the arc.
4. Wear protective clothing made from durable, flame-resistant material (wool and leather) and foot safety protection.
5. Never wear contact lenses while plasma cutting.

13.4.3 Noise Can Damage Hearing



CAUTION! *Noise from some processes can damage hearing. Use AS/NZS compliant ear plugs or ear muffs if the noise level is high.*

13.4.4 Work Environment Safety



DANGER! Remove any combustible material from the work area.

1. When possible, move the work to a location well away from combustible materials. If relocation is not possible, protect the combustibles with a cover made of fire resistant material.
2. Remove or make safe all combustible materials for a radius of 10 metres around the work area. Use a fire resistant material to cover or block all doorways, windows, cracks, and other openings.
3. Enclose the work area with portable fire resistant screens. Protect combustible walls, ceilings, floors, etc., from sparks and heat with fire resistant covers.
4. If working on a metal wall, ceiling, etc., prevent ignition of combustibles on the other side by moving the combustibles to a safe location. If relocation of combustibles is not possible, designate someone to serve as a fire watch, equipped with a fire extinguisher, during the cutting process and well after the cutting is completed.
5. Do not weld or cut on materials having a combustible coating or combustible internal structure, as in walls or ceilings, without an approved method for eliminating the hazard.
6. After cutting or welding, make a thorough examination for evidence of fire. Be aware that visible smoke or flame may not be present for some time after the fire has started. Do not weld or cut in atmospheres containing dangerously reactive or flammable gases, vapours, liquids, and dust. Provide adequate ventilation in work areas to prevent accumulation of flammable gases, vapours, and dust.
7. Do not apply heat to a container that has held an unknown substance or a combustible material whose contents, when heated, can produce flammable or explosive vapours. Clean and purge containers before applying heat. Vent closed containers, including castings, before preheating, welding, or cutting.

13.4.5 Electricity Can Kill



DANGER! Touching live electrical parts can cause fatal shocks or severe burns.
The electrode and work circuit is electrically live whenever the output is on.

The input power circuit and machine internal circuits are also live when power is on. Incorrectly installed or improperly grounded equipment is a hazard.

1. Do not touch live electrical parts.
2. Wear dry, hole-free insulating gloves and body protection.
3. Insulate yourself from the work and the ground using dry insulating mats or covers.
4. Disconnect input power before installing or servicing this equipment. Lock input power, disconnect switch open, or remove line fuses so power cannot be turned on accidentally.
5. Properly install and ground this equipment according to national, state, and local codes.

6. Turn off all equipment when not in use. Disconnect power to equipment if it will be left unattended or out of service.
7. Never dip the plasma torch in water to cool it.
8. Do not use worn, damaged, undersized, or poorly spliced cables.
9. Do not wrap cables around your body.
10. Connect work piece to a good electrical ground.
11. Do not touch the torch tip machine is connected to power supply.
12. Use only well-maintained equipment. Repair or replace damaged parts as soon as practical.

13.4.6 Fumes And Gases



WARNING! *Plasma cutting produces fumes and gases. Breathing these fumes and gases can be hazardous to your health.*

1. Keep your head out of the fumes. Do not breathe the fumes.
2. If inside, ventilate the area and/or use an exhaust at the arc to remove plasma cutting fumes and gases.
3. If ventilation is poor, use an approved supplied-air respirator (PAPR).
4. Read the Safety Data Sheets (SDS) and the manufacturer's instruction for the metals, consumables, coatings, and cleaners.
5. Work in a confined space only if it is well ventilated, or while wearing an air-supplied respirator. Be sure the breathing air is safe.
6. Do not use plasma cutter in locations near degreasing, cleaning, or spraying operations. The heat and rays of the arc can react with vapours to form highly toxic and irritating gases.
7. Do not plasma cut on coated metals, such as galvanized, lead, or cadmium plated steel, unless the coating is removed from the cut area, the area is well ventilated, and if necessary, while wearing an air-supplied respirator. The coatings and any metals containing these elements can give off toxic fumes if plasma cut.

13.4.7 Fire & Explosive Risks



WARNING! *Sparks and spatter fly off when plasma cutting. The flying sparks and hot metal, weld spatter, work piece, and hot equipment can cause fires and burns.*

Accidental contact of torch tip to metal objects can cause sparks, overheating, or fire.

1. Protect yourself and others from flying sparks and hot metal.
2. Do not operate where flying sparks can strike flammable material.
3. Remove all flammables within 10m of the plasma cutting site.

4. Be alert that plasma cutting sparks and hot materials from plasma cutting can easily go through small cracks and openings to adjacent areas.
5. Watch for fire, and keep a fire extinguisher nearby.
6. Be aware that plasma cutting on a ceiling, floor, bulkhead, or partition can cause fire on the hidden side.
7. Do not plasma cut on closed containers such as tanks or drums.
8. Connect the work lead/clamp to the job as close to the plasma cutting area as practical to prevent plasma cutting current from traveling long, possibly unknown paths and causing electric shock and fire hazards.

13.4.8 Sparks & Hot Metal



WARNING! Chipping and grinding causes flying metal, and as welds cool they can throw off slag.

1. Wear an AS/NZS approved face shield or safety goggles. Side shields are recommended.
2. Wear appropriate safety equipment to protect the skin and body.

14 WARRANTY

14.1.1 Warranty Link

For full details on warranty period and terms and conditions, go to www.weldclass.com.au/WarrantyInfo



Weldclass

Be Outstanding

www.Weldclass.com.au