

KINCROME C

PROFESSIONAL QUALITY TOOLS

1/2" DRIVE AIR IMPACT WRENCH HEAVY DUTY

2
YEAR
WARRANTY

1492NM
MAX
TORQUE

LOW
AIR
CONSUMPTION

TWIN
HAMMER
MECHANISM



K13205

ED1 Sept 15

Table of Contents

Know Your Product	1
General Safety Instructions	2
Additional Safety Instructions.....	3
Operation.....	4-5
Maintenance & Warranty	5
Parts Breakdown	6

Know your product

1. Air Inlet
2. Exhaust
3. Variable Trigger
4. Speed Dial
5. Forward/Reverse Button
6. Anvil 1/2"
7. Nitto Style Fitting



Model No:	K13205
Description:	Impact Wrench Heavy Duty
Max Torque	1492Nm (1100ft.lb)
Air Inlet:	1/4"
Overall Length:	186mm
Drive Type:	1/2" (Square)
Clutch Type:	Twin Hammer
Free Speed:	5000RPM
Average Air Consumption	139LPM (4.9CFM)
Air Pressure Maximum:	90PSI
Max Hose Length:	10 Meters
Min. Hose Inner Diameter:	10mm (3/8")
Weight	2.4Kg

General Safety Warnings



Save all warnings and instructions for future reference.

WARNING! Read all safety warnings and all instructions. Failure to follow the warnings and instructions may result in serious injury.

1) Work Area

- a. **Keep the work area clean and well lit.** Cluttered benches and dark areas increase the risks of electric shock, fire, and injury to persons.
- b. **Keep bystanders, children, and visitors away while operating the tool.** Distractions are able to result in the loss of control of the tool.
- c. **Keep children and bystanders away while operating any powered products.** Distractions may result in loss of control.

2) Personal Safety

- a. **Stay alert. Watch what you are doing and use common sense when operating the tool.** Do not use the tool while tired or under the influence of drugs, alcohol, or medication. A moment of inattention while operating the tool increases the risk of injury to persons.
- b. **Dress properly. Do not wear loose clothing or jewellery.** Contain long hair. Keep hair, clothing, and gloves away from moving parts. Loose clothes, jewellery, or long hair increases the risk of injury to persons as a result of being caught in moving parts.
- c. **Avoid unintentional starting.** Be sure the switch is off before connecting to the air supply. Do not carry the tool with your finger on the switch or connect the tool to the air supply with the switch on.
- d. **Remove adjusting keys and wrenches before turning the tool on.** A wrench or a key that is left attached to a rotating part of the tool increases the risk of personal injury.
- e. **Do not overreach.** Keep proper footing and balance at all times. Proper footing and balance enables better control of the tool in unexpected situations.
- f. **Use safety equipment.** A dust mask, non-skid safety shoes and a hard hat must be used for the applicable conditions. Wear heavy-duty work gloves during use.
- g. **Always wear eye protection.** Wear approved safety eye protection.
- h. **Always wear hearing protection when using the tool.** Prolonged exposure to high intensity noise can contribute to hearing loss.

3) Tool Use and Care

- a. **Use clamps or other practical ways to secure and support the workpiece to a stable platform.** Holding the work by hand or against the body is unstable and can lead to loss of control.
- b. **Do not force the tool. Use the correct tool for the application.** The correct tool will do the job better and safer at the rate for which the tool is designed.
- c. **Do not use the tool if the switch does not turn the tool on or off.** Any tool that cannot be controlled with the switch is dangerous and must be repaired, at an authorised repair agent.
- d. **Disconnect the tool from the air source before making any adjustments, changing accessories, or storing the tool. Such preventive safety measures reduce the risk of starting the tool unintentionally.** Turn off and detach the air supply, safely discharge any residual air pressure, and release the throttle and/or turn the switch to its off position before leaving the work area.
- e. **Store the tool when it is idle out of reach of children and other untrained persons.** A tool is dangerous in the hands of untrained users.
- f. **Maintain the tool with care.** A properly maintained tool is easier to control.
- g. **Check for misalignment or binding of moving parts, breakage of parts, and any other condition that affects the tool's operation.** If damaged, have the tool serviced before using. Many accidents are caused by poorly maintained tools.
- h. **Use only accessories that are identified by the manufacturer for the specific tool model.** Use of an accessory not intended for use with the specific tool model, increases the risk of injury to persons.

4) Service





- a. Tool service must be performed only by qualified repair personnel.
- b. When servicing a tool, use only identical replacement parts. Use only authorized parts.
- c. Use only the lubricants specified by the manufacturer.

5) Additional Safety Warnings

- a. The warnings and precautions discussed in this manual cannot cover all possible conditions and situations that may occur. It must be understood by the operator that common sense and caution are factors which cannot be built into this product, but must be supplied by the operator.
- b. Only use with accessories rated to handle the forces exerted by this tool during operation. Other accessories not designed for the forces generated may break and forcefully launch pieces.
- c. Attach all accessories properly to the tool before connecting the air supply. A loose accessory may detach or break during operation.
- d. Thoroughly read and understand the manual for the air compressor used to power this tool. Install an in-line shutoff valve to allow immediate control over the air supply in an emergency, even if a hose is ruptured.
- e. Use this tool with both hands only. Using tools with only one hand can result in loss of control.
- f. Do not lay the tool down until it has come to a complete stop. Moving parts can grab the surface and pull the tool out of your control.
- g. Do not force the tool. Use a larger one if needed.
- h. Use a torque wrench to verify tightness of all fasteners after use (If required).
- i. Do not hold sockets, anvil or adapters during use.
- j. Anyone using vibrating tools regularly or for an extended period should first be examined by a doctor and then have regular medical check-ups to ensure medical problems are not being caused or worsened from use. Pregnant women or people who have impaired blood circulation to the hand, past hand injuries, nervous system disorders, diabetes, or Raynaud's Disease should not use this tool. If you feel any symptoms related to vibration (such as tingling, numbness, and white or blue fingers), stop using immediately and seek medical advice as soon as possible.
- k. Do not smoke during use. Nicotine reduces the blood supply to the hands and fingers, increasing the risk of vibration-related injury.
- l. Wear suitable gloves to reduce the vibration effects on the user.

6) Description of Symbols

The following symbols could be shown on the tool:

	Read the instruction manual before use.		Risk of Explosion
	Wear Ear Protection		Wear Eye Protection
no	No-load speed, Free Speed	CFM	Cubic Feet per Minute flow
.../min, RPM	Revolutions or reciprocation per minute	SCFM	Cubic Feet per Minute flow at standard conditions
PSI	Pounds per square inch of pressure	NPT	National pipe thread, tapered
ft-lb	Foot-pounds of torque	BPM	Beats/ Blows per minute
Nm	Newton meters of force	BSP	British standard pipe

Impact Wrench User Instructions

7) Before Starting

TO PREVENT SERIOUS INJURY FROM EXPLOSION:



Verify compressor is off before setup. Use only clean, dry, regulated, compressed air to power this tool. Do not use oxygen, carbon dioxide, combustible gases, or any other bottled gas as a power source for this tool.

1. It is recommended a filter, regulator with pressure gauge, oiler, in-line shut-off valve, and quick coupler be fitted for optimal operation, as shown on Figure A.
2. An in-line shut-off ball valve is an important safety device, it will shut-off the air supply even if the air hose is ruptured. The shut-off valve should be a ball valve because it can be closed quickly.

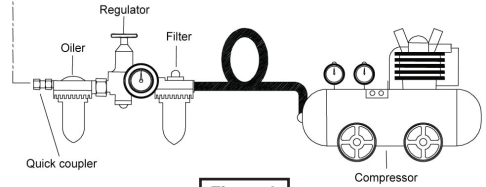
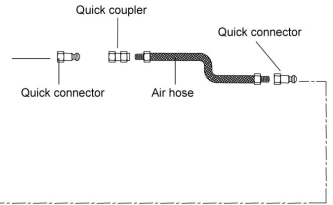

Figure A

Note: If an automatic oiler system is not used, add a 4 to 5 drops of Kinchrome Air Tool Oil to the air inlet before operation. Add 1-2 drops every hour for continual use.

3. Attach an air hose to the compressor's air outlet. Connect the air hose to the air inlet (1) of the tool. Other components, such as a quick connect fitting and quick connect coupler, will make operation more efficient, but are not required.



WARNING! Do not install a quick coupler directly on the tool. Couplers contains an air valve that will allow the air tool to retain pressure and inadvertently operate after the air supply is disconnected.

4. The air hose must be long enough to reach the work area and allow free movement while working.
5. Turn on the air compressor according to the manufacturer's directions and allow the tank to build up pressure until it cuts-off.
6. Adjust the air compressor's regulator so that the air output is at the tools recommended working pressure, the output must not exceed the tool's maximum air pressure at any time. Adjust the pressure gradually, while checking the air output gauge to set the optimal pressure range.
7. Inspect all air connections for leaks. Repair any leaks.
8. If the tool is not being used, turn off and detach the air supply, safely discharge any residual air pressure, and release the trigger (2) and/or turn the tools switch to its off position to prevent inadvertent operation.

8) Operation

1. Screw in Nitto Style Fitting (6) to the air inlet (1). Thread (teflon) tape may be required to ensure a leak free seal.
2. Connect the air hose to the air inlet (1) of the tool.
3. Push and lock a 1/2" drive socket (not included) onto the Anvil (6). (Use only Impact Rated Kinchrome Sockets)
4. The Impact Wrench can be used in either Forward or Reverse direction by push the forward/reverse button (5) backwards or forwards.

Note: There are 3 speed/torque settings for the forward and 1 speed for reverse direction.

5. For forward, from the front of the impact wrench push the forward/reverse button (5) backwards.
6. For Reverse, from the back of the impact wrench push the forward/reverse button (5) forwards.
7. To tighten a nut or bolt, place the socket (not included) over the nut or bolt head of bolt you wish to tighten.
8. Hold the handle firmly and place other hand on top of tool. Then gently squeeze the trigger (3). When the nut or bolt is tightened or loosened, release the trigger (3).
9. To loosen, set the forward/reverse button (5) to the Reverse setting.
10. Place socket (not included) over desired nut or bolt head, hold the handle firmly and place other hand on top of tool and gently squeeze the trigger (3). When the nut or bolt is tightened or loosened, release the trigger (3).
11. If tool requires more power to accomplish task in forward or reverse, ensure that the tool is receiving sufficient, un-obstructed airflow (CFM), increase/decrease the pressure (PSI) output of regulator ensuring you do not exceed the rated maximum inlet air pressure of the tool.

Caution: Do not exceed tool's maximum inlet air pressure rating (90 PSI). If tool still does not have sufficient force at maximum pressure and sufficient airflow, then a larger tool may be required.

To change the speed setting

1. To select slow speed/high torque rotate the speed dial (4) to the left.
2. To select medium speed/medium torque rotate the speed dial (4) to the central position.
3. To select fast speed/low torque dial rotate the speed dial (4) to the right position.

9) Cleaning, Maintenance, and Lubrication

Note: These procedures are in addition to the regular checks and maintenance explained as part of the regular operation of the air-operated tool.

The air motor and bearing uses compressed air to power the tool. Moisture in compressed air will rust the motor components, you must lubricate the motor daily with Kincome air tool oil.

Lubrication

1. Disconnect the tool from the air supply holding it so the air inlet (1) faces up.
2. Hold the trigger (3) down and put 4 to 5 drops of Kincome Air Tool Oil in the air inlet (1). Holding the trigger (3) down helps circulate oil in the motor.
3. Connect the tool to air supply, cover the exhaust (2) with a towel and run for a few seconds.



WARNING! Any excess oil in the motor is immediately expelled from the exhaust (2). Always direct exhaust (2) away from people or objects.

Storage

1. Avoid storing the tool in a location subject to high humidity. If the tool is left as it is used, the residual moisture inside the tool can cause rust. Before storing and after operation, oil the tool and run it for a short time.
2. Regular inspection should be carried out of spindles, threads, and clamping devices in-respect of wear and for location of abrasive products.

10) Warranty

Warranty given by Kincome Australia Pty Ltd of 3 Lakeview Drive, Caribbean Park, Scoresby, Victoria (Tel 1300 657 528).

The applicable warranty period (24 months) commences on the date that the product is purchased. If this product has materials or workmanship defects (other than defects caused by abnormal or non warranted use) you can, at your cost, send the product to place of purchase, an authorised Kincome service agent or one of Kincomes addresses for repair or replacement. Your rights under this warranty are in addition to any other rights you have under the Australian Consumer Law or other applicable laws. Our goods come with guarantees that cannot be excluded under the Australian Consumer Law. You are entitled to a replacement or refund for a major failure and compensation for any other reasonably foreseeable loss or damage. You are also entitled to have the goods repaired or replaced if the goods fail to be of acceptable quality and the failure does not amount to a major failure. For further details please visit www.kincrome.com.au or call us. Due to minor changes in design or manufacture, the product you purchase may sometimes differ from the one shown on the packaging..

IMPORTANT! If the tool fails to operate correctly, call customer service on 1800 657 528 for advice on the best resolution for your situation. If a resolution cannot be achieved over the phone please take the tool and all related accessories to an authorised service centre or place of purchase showing proof of purchase for assistance.

11) Parts Breakdown

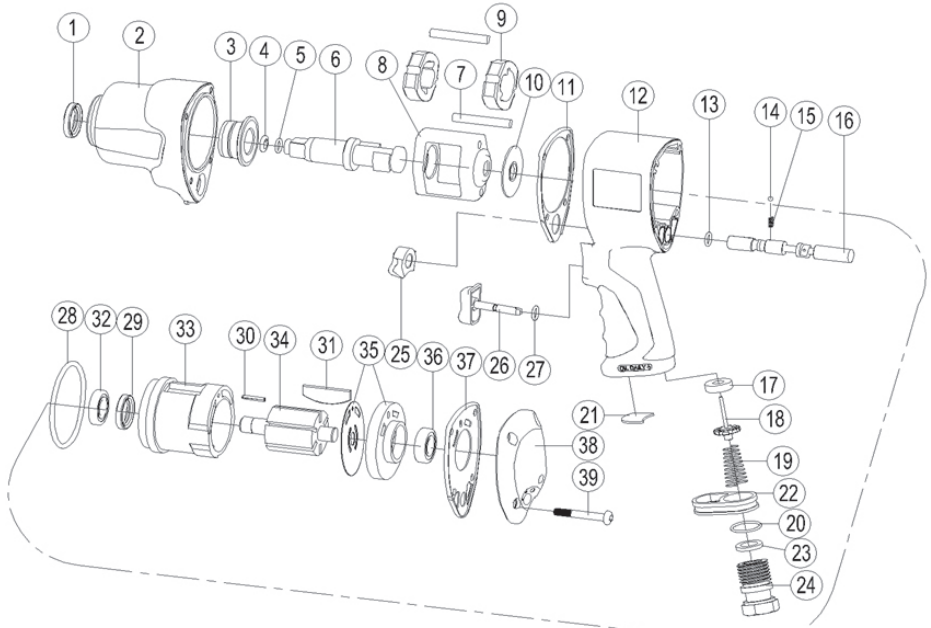

PARTS NO.	DESCRIPTION	QTY	PARTS NO.	DESCRIPTION	QTY
K13205-1	Oil Seal	1	K13205-21	Muffler	1
K13205-2	Hammer Case	1	K13205-22	Exhaust Deflector	1
K13205-3	Bushing	1	K13205-23	Washer	1
* K13205-4	Anvil Collar	1	K13205-24	Hose Adaptor -19PT	1
* K13205-5	O-Ring	1	K13205-25	Regulator Knob	1
* K13205-6	Anvil	1	K13205-26	Trigger	1
K13205-7	Hammer Pin	2	K13205-27	O-Ring	1
K13205-8	Hammer Cage	1	K13205-28	O-Ring	1
K13205-9	Hammer Dog	2	K13205-29	Oil Seal	1
K13205-10	Washer	1	K13205-30	Spring Pin	1
* K13205-11	Front Gasket	1	* K13205-31	Rotor Blade	6
K13205-12	Motor Housing	1	K13205-32	Ball Bearing	1
K13205-13	O-Ring	1	K13205-33	Cylinder	1
* K13205-14	Steel Ball	1	K13205-34	Rotor	1
* K13205-15	Spring	1	K13205-35	Rear Plate	1
K13205-16	Reverse Valve	1	K13205-36	Ball Bearing	1
K13205-17	Retainer	1	* K13205-37	Rear Gasket	1
K13205-18	Valve Stem	1	K13205-38	Rear Cover	1
K13205-19	Spring	1	K13205-39	Screw	4
K13205-20	O-Ring	1	* DENOTES STOCKED SPARE PART		

K13205 WE RESERVE THE RIGHT TO CHANGE SPARE PARTS WITHOUT NOTICE

* INDICATES STOCKED SPARE PARTS

KINCROME 
PROFESSIONAL QUALITY TOOLS

www.kincrome.com.au