

*X*series

MST

MIG • STICK • TIG Inverter

**AC/DC MULTI PROCESS
INVERTER WELDER
240V MANUAL**



MST200X4
Inverter Welder



BOSSWELD
WELD LIKE A BOSS

*X*series

Thank you for choosing a BOSSWELD MST 200 X4 AC/DC Multi Process Inverter Welder

In this manual you will find instructions on how to set up your welder along with general welding information, safety information and helpful tips. We encourage you to go online to our website for more tips and troubleshooting as well as many welding resources.

The BOSSWELD MST 200 X4 is the latest in IGBT multipurpose welder technology, this very portable power source enables the user to complete high quality welds in both MIG - TIG - MMA/Stick electrode applications. This welder is easy to set up, easy to use and will provide very smooth output.

We truly hope you enjoy using your welder!

**M**

MIG

- Simple to learn
- MIG Wire is fed through the gun to create the weld pool
- Gas or flux prevents oxidation in the weld
- Weld with or without gas
- Point and pull the trigger
- Great for maintenance, small projects & automotive repairs

METAL TYPES

Mild steel, stainless steel & aluminium

S

STICK

- Easiest process to learn
- Best choice for quick repairs
- Slower than MIG welding
- Forgiving in dirty/rusty environments
- Not recommended for thin sheet metal welding

METAL TYPES

Mild steel, stainless steel & cast iron

T

TIG

- Gives a better weld finish
- Accurate heat control
- Considered the most challenging process to learn
- Good way to weld thin material
- Argon gas is required

METAL TYPES

Mild steel, stainless steel & aluminium

CONTENTS	PAGE
WARRANTY	4
BOX CONTENTS	5
WARNINGS	6
MACHINE CARE / SAFETY INSTRUCTIONS	7
WORK AREA SAFETY	8
MAINTENANCE & DISPOSAL / GAS BOTTLE	9
FRONT & REAR PANEL LAYOUT	10
MACHINE CONTROLS PANEL & SIDE PANEL (INSIDE)	11
DUTY CYCLE	12
MIG SYNERGIC SETUP	13
MIG MANUAL SETUP (GAS)	16-17
MIG MANUAL SETUP (GASLESS)	18
MIG MANUAL SPOOL GUN SETUP (GAS)	20-22
MIG MANUAL SPOOL GUN SETUP (GASLESS)	23
BASIC MIG WELDING GUIDE	24-26
SETTING GUIDES FOR WELDING WITH MST 200X4	27
TIG SETUP	28-31
LIFT ARC START AND HR ARC START	32
TUNGSTEN PREPARATION & GRINDING AND FOOT CONTROL OPTION	33
BASIC TIG WELDING GUIDE	34
AC / DC WELDING	34-35
PULSE TIG WELDING	36
STICK AC / DC SETUP	37-38
GENERAL MMA WELDING GUIDE	39
SET UP OF WIRE SPOOL & WIRE FEED UNIT	40
MIG TORCH SETUP	41
MACHINE DRIVE ROLLER SIZE GUIDE	41
MIG TORCH LINER INSTALLATION / REPLACEMENT	42
MIG TORCH AND CONSUMABLE CARE	43
LIST OF ERROR CODES	44
JOB PROGRAM DISPLAY INTRODUCTION	44
BZ 24 MIG TORCH PARTS BREAK DOWN	45
17 TIG TORCH PARTS BREAKDOWN	46
SPOOL GUN PARTS BREAKDOWN	47
HELPFUL INFORMATION & TROUBLE SHOOTING	48-51



WARRANTY

This warranty is in addition to the statutory warranty provided under Australian Consumer Law, but does not include damage resulting from transport, misuse, neglect or if the product has been tampered with. The product must be maintained as per this manual, and installed and used according to these instructions on an appropriate power supply. The product must be used in accordance with industry standards and acceptable practice.

This warranty covers the materials used to manufacture the machine and the workmanship used to produce the item. This Warranty does not cover damage caused by:

1. Normal wear and tear due to usage
2. Misuse /abuse or Neglect of the item
3. Transport / handling breakages
4. Lack of maintenance, care and cleaning
5. Environmental factors, such as usage in temperatures exceeding 40 degrees, above 1000mt sea level, rain, water, excessive damp, cold or humid conditions.
6. Improper setup or installation
7. Use on Incorrect voltage or non authorised electrical connections and plugs
8. Use of non standard parts
9. Repair, case opening, tampering with, modifications to any part of the item by non authorised BOSSWELD repairers.

This warranty covers the machine only and does not include Torches, Leads, Earth Clamps, Electrode holders, Plasma Torches, Tig Torches and any of the parts on those items unless there is a manufacturing fault.

1. REGISTRATION

Purchasers are encouraged to register for warranty on our website. www.bossweld.com.au/warranty

2. TIME PERIOD - 3 Years

A warranty claim must be made within 3 years from the date of purchase of this product. Any claim must include proof of purchase.

3. HOW TO MAKE A CLAIM - NEED SOME HELP?

- Visit our website www.bossweld.com.au/troubleshooting for many helpful tips and guides to assist with the setup and usage of your new machine. Still stuck....?
- Call the BOSSWELD Helpdesk on 1300 899 710 for over the phone assistance.
- If the machine is not operational then return the item to the place of purchase.

Note:

If this welders duty cycle is exceeded the welder will enter “thermal overload” which will automatically stop the welding output in order to protect, both the user and the welder. You will know the welder has gone into thermal overload when the overload error indicator light is illuminated. The welder will then cool itself down, and once the overload error indicator light is no longer illuminated, welding can then re-commence. Please note. Exceeding the machine’s duty cycle, cannot be considered grounds for warranty or return.

BOSSWELD MAKES NO OTHER WARRANTY, EXPRESS OR IMPLIED. THIS WARRANTY IS EXCLUSIVE AND IN LIEU OF ALL OTHERS, INCLUDING, BUT NOT LIMITED TO ANY WARRANTY OF MERCHANTABILITY OR FITNESS FOR ANY PARTICULAR PURPOSE.

BOSSWELD MST 200 X4 AC/DC Multi Process Inverter Welder Box Contents

1. BOSSWELD MST 200 X4 AC/DC Multi Process Inverter Welder
2. 3 metre BZ 24 Series MIG Torch
3. 4 metre 17 Series TIG Torch
4. 3 metre welding cable with electrode holder
5. 3 metre earth cable with earth clamp
6. 2 metre quick connect gas hose
7. Dual stage Argon regulator
8. Spanner
9. 0.8/0.9mm V groove drive rollers (Fitted)
0.8/0.9mm Knurled drive roller (Spare)
10. Operating manual (not shown)

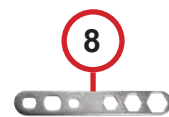

Note: Pictures may vary from your machine model



WARNING

The device and packaging material are not toys! Children must not be allowed to play with the machine and its accessories. Plastic parts and packaging are choking risks for children.

- Open the packaging and remove the welder carefully.
- Check that the delivery is complete.
- If possible, store the packaging until the warranty period has expired.

PERSONAL PROTECTIVE EQUIPMENT (PPE)



GLOVES AND PROTECTIVE CLOTHING

Use protective gloves and fire resistant protective clothing when welding. Avoid exposing skin to ultraviolet rays produced by the arc.



WELDING HELMET

Under no circumstances should the welder be operated unless the operator is wearing a welding helmet to protect the eyes and face. There is serious risk of eye damage if a helmet is not used. The sparks and metal projectiles can cause serious damage to the eyes and face. The light radiation produced by the arc can cause damage to eyesight, and burns to skin. Never remove the welding helmet whilst welding.



SAFETY GLASSES

After welding use appropriate safety glasses when brushing, chipping or grinding the slag from the weld.



OTHER PERSONS

Ensure that other persons are screened from the welding arc and are at least 15 metres away from the work piece. Always ensure that the welding arc is screened from onlookers, or people just passing by. Use screens if necessary, or non-reflecting welding curtain. Do not let children or animals have access to the welding equipment or to the work area.



SWITCHING OFF

When the operator has finished welding they must switch the welder off.

DO NOT put the electrode holder down with the welder switched ON.

When leaving the welder unattended, move the ON/OFF switch to the OFF position and disconnect the welder from the electrical mains supply.

Do not leave hot material unattended after welding.



FUMES & GASES ARE DANGEROUS

Smoke and gas generated whilst welding or cutting can be harmful to people's health. Welding produces fumes and gases. Breathing these fumes and gases can be hazardous to your health.

- Do not breathe the smoke and gas generated whilst welding or cutting, keep your head out of the fumes
- Keep the working area well ventilated, use fume extraction or ventilation to remove welding fumes and gases.
- In confined or heavy fume environments always wear an approved air-supplied respirator. Welding fumes and gases can displace air and lower the oxygen level causing injury or death. Be sure the breathing air is safe.
- Do not weld in locations near de-greasing, cleaning, or spraying operations. The heat and rays of the arc can react with vapours to form highly toxic and irritating gases.
- Materials such as galvanized, lead, or cadmium plated steel, containing elements that can give off toxic fumes when welded. Do not weld these materials unless the area is very well ventilated, and or wearing an air supplied respirator.



MACHINE CARE / SAFETY

Keep the welding cables, earth clamp and electrode holder in good condition. Failure to do this can result in poor welding quality, which could be dangerous in structural situations.

Prior to use, check for breakage of parts and any other conditions that may affect operation of the welder. Any part of the welder that is damaged should be carefully checked to determine whether it will perform its intended function whilst being safe for the operator. Any part that is damaged should be properly repaired, or replaced by an authorised service centre.

IMPROPER USE

It is hazardous to use the welding machine for any work other than that for which it was designed e.g. do not use welder for thawing pipes.

HANDLING

Ensure the handle is correctly fitted. As welding machines can be heavy, always use safe lifting practices when lifting.

POSITION AND HANDLING

To reduce risk of the machine being unstable / danger of overturning, position the welding machine on a horizontal surface that is able to support the machine weight. Operators **MUST NOT BE ALLOWED** to weld in raised positions unless safety platforms are used.



SAFETY INSTRUCTIONS

WARNING

The user of this welder is responsible for their own safety and the safety of others. It is important to read, understand and respect the contents of this user guide. When using this welder, basic safety precautions, including those in the following sections must be followed to reduce the risk of fire, electric shock and personal injury. Ensure that you have read and understood all of these instructions before using this welder.

Persons who are not familiar with this user guide should not use this welder. Keep this booklet in a safe place for future reference.

TRAINING

The operator should be properly trained to use the welding machine safely and should be informed about the risks relating to arc welding procedures. This user guide does not attempt to cover welding technique. Training should be sought from qualified / experienced personnel on this aspect, especially for any welds requiring a high level of integrity for safety.





SERIOUS FIRE RISK

The welding process produces sparks, droplets of fused metal, metal projectiles and fumes.

This constitutes a serious fire risk. Ensure that the area in which welding will be undertaken is clear of all inflammable materials. It is also advisable to have a fire extinguisher, and a welding blanket on hand to protect work surfaces.



WORK AREA

-  Ensure a clear, well lit work area with unrestricted movement for the operator.
-  The work area should be well ventilated, as welding emits fumes which can be dangerous.
-  Always maintain easy access to the ON/OFF switch of the welder, and the electrical mains supply.
-  Do not expose the welder to rain and do not operate in damp or wet locations

Where welding must be undertaken in environments with increased risk of electric shock, confined spaces or in the presence of flammable or explosive materials, it is important that the environment be evaluated in advance by an “expert supervisor”. It is also recommended that welding in these circumstances be carried out in the presence of persons trained to intervene in emergencies.

AVOID ELECTRICAL CONTACT

Use adequate electrical insulation with regard to the electrode, the work piece and any accessible earthed metal parts in the vicinity. Avoid direct contact with the welding circuit. The no load voltage between the earth clamp and the electrode can be dangerous under certain circumstances.

Note: For additional protection from electric shock. It is recommended that this welder be used in conjunction with a residual current device (RCD) with rated residual current of 30MA or less.

In general the use of extension leads should be avoided. If used however, ensure that the extension lead is used with the welder is of a suitable current rating and heavy duty in nature that **MUST** have an earth connection. If using the welder outdoors, ensure that the extension lead is suitable for outdoor use. Always keep extension leads away from the welding zone, moisture and any hot materials.

WELDING SURFACES

Do not weld containers or pipes that hold, or have held, flammable liquids or combustible gases or pressure. Do not weld on coated, painted or varnished surfaces as the coatings may ignite, or can give off dangerous fumes.

WORK PIECE

When welding, the work piece will remain at high temperature for a relatively long period. The operator must not touch the weld or the work piece unless wearing welding gloves. Always use pliers or tongs. Never touch the welded material with bare hands until it has completely cooled.

VOLTAGE BETWEEN ELECTRODE HOLDERS OR TORCHES

Working with more than one welding machine on a single work piece, or on work pieces that are connected, may generate a dangerous accumulation of no-load voltage between two different electrode holders or torches, the value of which may reach double the allowed limit.



MAINTENANCE

WARNING

Before starting any cleaning, or maintenance procedures on the welding machine, make sure that it is switched OFF and disconnected from the mains supply.

There are no user serviceable parts inside the welder. Refer to a qualified service personnel if any internal maintenance is required. After use, wipe the welder down with a clean soft dry cloth.

Regular inspection of the supply cord is required and if damaged is suspected, it must be immediately replaced by the manufacturer, its service agent or similarly qualified persons in order to avoid a hazard

STORAGE/ TRANSPORT

Store the welder and accessories out of children's reach in a dry place. If possible store the welder in the original packaging. The appliance must unconditionally be secured against falling or rolling over during transport.



DISPOSAL

DISPOSING OF THE PACKAGING

Recycling packaging reduces the need for landfill and raw materials. Reuse of the recycled material decreases pollution in the environment. Please recycle packaging where facilities exist. Check with your local council authority for recycling advice.

DISPOSING OF THE WELDER

Welders that are no longer usable should not be disposed of with household waste but in an environmentally friendly way. Please recycle where facilities exist. Check with your local council authority for recycling advice.



GAS BOTTLE

ATTENTION! - CHECK FOR GAS LEAKS

At initial set up and at regular intervals we recommend to check for gas leakage

Recommended procedure is as follows:

1. Connect the regulator and gas hose assembly and tighten all connectors and clamps.
2. Slowly open the cylinder valve.
3. Set the flow rate on the regulator to approximately 10-15 l/min.
4. Close the cylinder valve and pay attention to the needle indicator of the contents pressure gauge on the regulator, if the needle drops away towards zero there is a gas leak. Sometimes a gas leak can be slow and to identify it will require leaving the gas pressure in the regulator and line for an extended time period. In this situation it is recommended to open the cylinder valve, set the flow rate to 8-10 l/min, close the cylinder valve and check after a minimum of 15 minutes. Ensuring adequate ventilation fore small spaces.
5. If there is a gas loss then check all connectors and clamps for leakage by brushing or spraying with / soapy water, bubbles will appear at the leakage point.
6. Tighten clamps or fittings to eliminate gas leakage.

IMPORTANT! - We strongly recommend that you check for gas leakage prior to operation of your machine. We recommend that you close the cylinder valve when the machine is not in use. BOSSWELD, authorised representatives or agents of BOSSWELD will not be liable or responsible for the loss of any gas.

FRONT PANEL

1. Control Panel
2. Positive Output Connection Socket
3. MIG Torch Euro Connector
4. Control Socket
5. Polarity Switching Cable
6. TIG Torch Gas Connector
7. Negative Output Connection Socket



REAR PANEL

8. Power Switch
9. Input Power Cable
10. Cooling Fan
11. Gas Inlet Connector

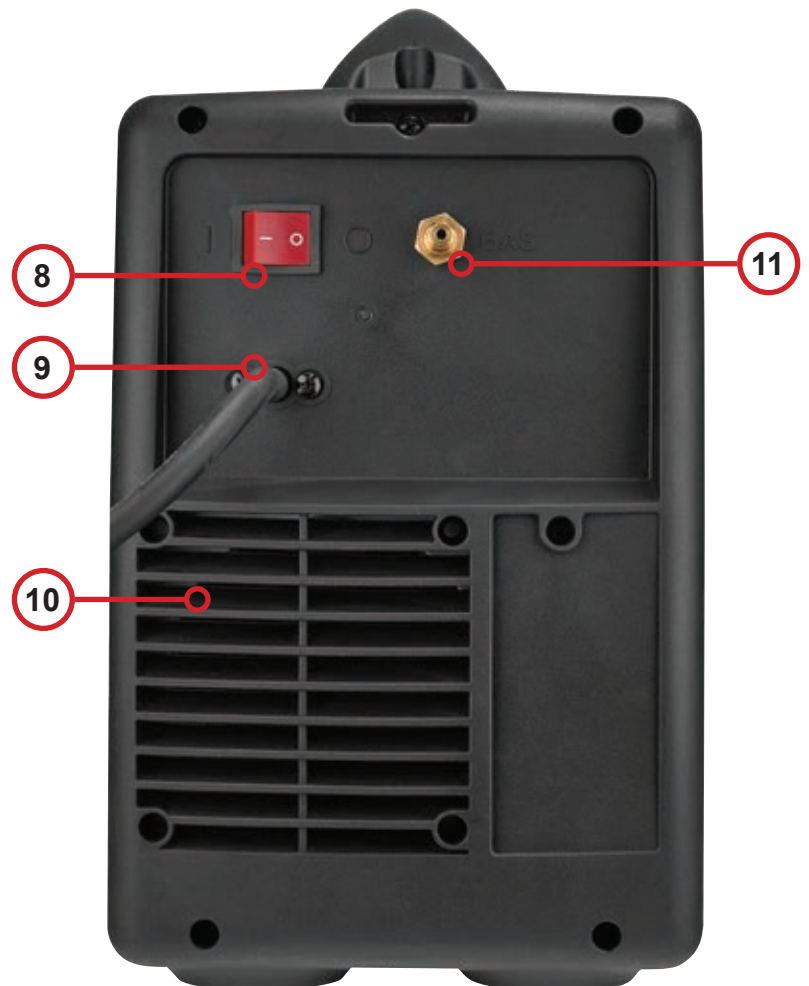

CONTROL PANEL



1. **Welding mode button:** MIG Synergic, MIG Manual, TIG Lift, TIG HF, Stick DC, Stick AC welding mode.
2. **Trigger mode button:** Direct select 2T or 4T trigger mode.
3. **JOB button:** Press for 3s to open JOB program and press for 1s to save parameters into JOB number.
4. **Synergic button:** Press to select wire material, wire diameter and type of gas.
5. **Gas check button:** Manually purge to gas lines.
6. **Manual wire feed button.**
7. **L parameter knob:** Press to select parameters and rotate to adjust values, such as welding current. In function interface, rotate to select parameters.
8. **Function button:** Press to select parameters or enter the function interface.
9. **R parameter knob:** Press to select parameters and rotate to adjust values.

SIDE PANEL (DOOR OPEN)

- A. Spool Hub
- B. Spool Hub Nut
- C. Wire Feed Tensioning Adjustment
- D. Idle Roller / Wire Tensioning Arm
- E. Wire Inlet
- F. Drive Roller
- G. Drive Roller Retainer Nut
- H. Wire Guide Inlet Tube

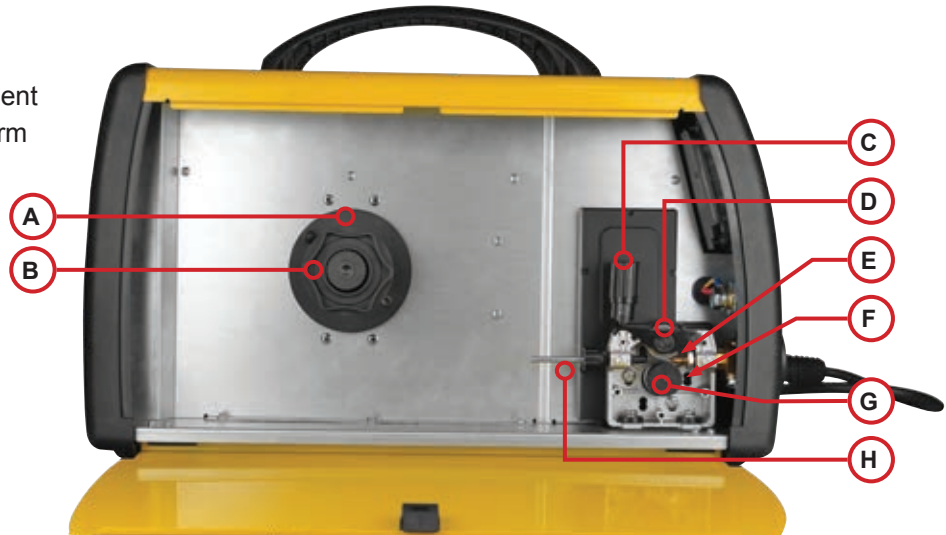

DUTY CYCLE:

Special note:

If this welders duty cycle is exceeded the welder will enter “thermal overload” which will automatically stop the welding output in order to protect, both the user and the welder. You will know the welder has gone into thermal overload when the overload error signal show on screen.
 The welder should not be welding for 10~15 minutes to cool down with the fan running. When operating the machine again, the welding output current or the duty cycle should be reduced. Please note.
 Exceeding the machine’s duty cycle, cannot be considered grounds for warranty or return.

The term duty cycle indicates the percentage welding time available at the output current for each 10 min period over 4 hours, The specification plate on the machine list three given ratings at a given current and voltage.

NOTE MIG SETTINGS SHOW BELOW : Amps refer to the Current setting

10%	60%	100%
200 - Amps	85-Amps	65-Amps
24.0 Volts	18.3 Volts	17.3 Volts

For example this means when the machine is set at is highest current of 200 Amps it can weld for 1 minute in a Ten minute period. The power source is protected by a built in temperature protection device, This will activate if the machine is operated in excess of its amperage and duty cycle rating.

BOSSWELD		PART NO.		699104								
MST 200 X4		STANDARD		EN 60974-1:2012								
		MIG (DC)		30A/15.5V-200A/24V								
		TIG (AC/DC)		10A/10.4V-200A/18V								
		MMA (AC/DC)		10A/20.4V-200A/28V								
		X		10%		60%		100%				
		MODE		MIG	TIG	MMA	MIG	TIG	MMA	MIG	TIG	MMA
		I ₂		200A	200A	200A	85A	85A	85A	65A	65A	65A
U ₂		24V	18V	28V	18.3V	13.4V	23.4V	17.3V	12.6V	22.6V		
		U _i =230V		I _{max}		I _{eff}						
1~50/60Hz				26.9A (MIG DC)		8.5A (MIG DC)						
				22.3A/22.0A (TIG AC/DC)		7.1A/7.0A (TIG AC/DC)						
				28.3A/31.6A (MMA AC/DC)		8.9A/10A (MMA AC/DC)						
IP21S		19kg										

Duty Cycle
 Amperage / Current
 Voltage



Amperage and Voltage display

MIG SYNERGIC SETUP

11 & 12. Fit gas regulator to bottle and install gas hose to the inlet on the back panel of welder. Turn on regulator and set gas flow to between 10-15 L/min depending on your welding environment

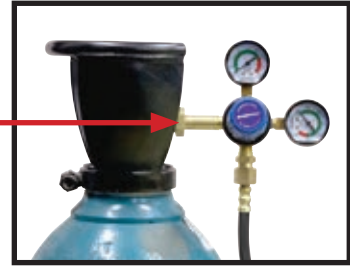

10. Select MIG Synergic mode

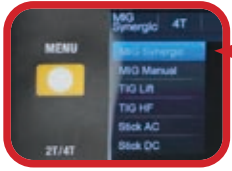

4. Connect polarity switching cable to the **+** terminal

4. Connect MIG Torch to the Euro Connection terminal
NOTE: Ensure connector nut is tighten firmly

5. Connect earth clamp to the **-** terminal

IMPORTANT! - We strongly recommend that you check for gas leakage prior to operation of your machine. We recommend that you close the cylinder valve when the machine is not in use. BOSSWELD authorised representatives or agents of BOSSWELD will not be liable or responsible for the loss of any gas.



1 Plug the machine 10Amp input power lead into the wall socket, ensuring that the power switch on the machine is in the **OFF** position.

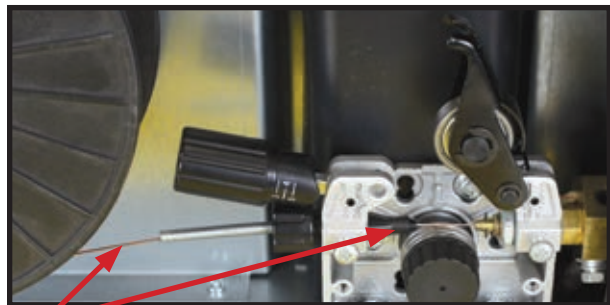

3 Set up the wire feed unit as per section "Set up Wire Feed Unit". Ref page 40

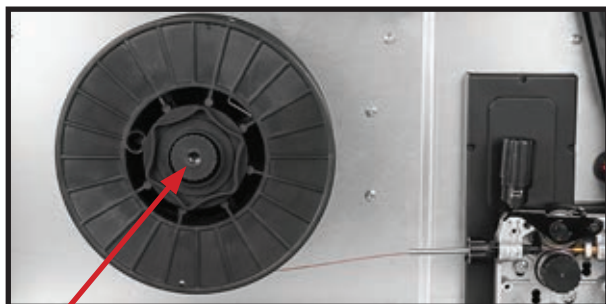

2 Open wire feed side panel and install **GAS** wire into machine ensuring the drive roller is matched to the wire size and type. Refer to Machine Drive Roller Size Guide on page 41
Note: Wire to roll from under spool into the wire guide inlet tube

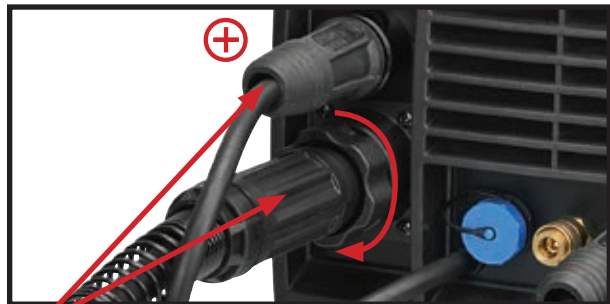

4 Install Euro connect MIG torch over the protruding wire, line up and screw the Euro connector nut up firmly. Ensure the polarity switching cable is plug into positive output connection socket for gas welding.



SETTING MACHINE POLARITY

DCEN - GASLESS		DCEP - GAS	
+		+	
-		-	

Note: Pictures may vary from your machine model

MIG SYNERGIC SETUP CONTINUE



5 Fit the Earth lead Dinse Plug to the negative terminal for gas welding and then connect earth clamp to the work piece ensuring that the clamp makes good contact with bare metal.



6 Switch the machine **ON** using the mains power switch. Wait a few seconds whilst the machine powers up.



7 Press Menu button and adjust knob to select MIG Synergic then press knob to confirm.



8 Remove nozzle and tip from torch and press wire feed button, this will feed the wire through the torch. Release button when wire appears at the end of the torch.



9 Re install tip and nozzle to torch and trim wire to the end of the nozzle.



10 Press Synergic button and adjust knob to select wire material, wire diameter & type of gas. Press knob to confirm.

Wire Material	Wire Diameter	Type of gas
Iron	Fe	∅ 0.6 / 0.8 / 0.9 / 1.0mm 80%Ar+20%CO2
Flux Cored Iron	Flux.c.w Fe	∅ 0.8 / 0.9 / 1.0mm CO2
Stainless Steel	Ss	∅ 0.8 / 0.9 / 1.0mm 98%Ar+2%CO2
Aluminium	Al	∅ 0.8 / 0.9 / 1.0mm Ar 100%
Copper-Silicon	Cusi3	Ar 100%



Follow Synergic control instruction to get the right type of gas to set up for this machine.

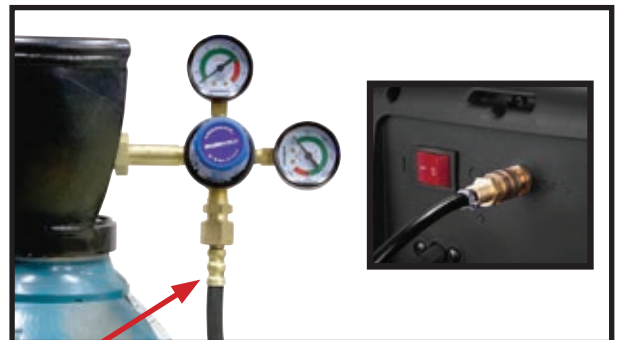

11 Fit gas regulator to the gas bottle and install gas hose to the gas inlet on the back panel of welder.

Note: Pictures may vary from your machine model

MIG SYNERGIC SETUP CONTINUE



12 Turn on regulator and set gas flow to between 10-15 L/min depending on your welding environment.



13 Press 2T/4T button to select 2T or 4T mode. **2T Mode.** Press the gun/torch trigger to weld and release to stop. **4T Mode.** Press and release the gun/torch trigger to start, weld without holding the trigger on and stop by pressing and releasing the trigger again.



14 To adjust functions, press parameter button, rotate left knob for function selection and rotate right knob for adjustment then press parameter button again for confirmation.

Function	Setting	
1 Trigger	2T or 4T	Selection for 2T and 4T.
2 Burnback	0 ~ 10	Selection for the amount of wire to 'burn back' after release the torch trigger.
3 Pre-Flow	0.1s ~ 5s	Selection for gas flow time prior to the arc starting.
4 Post Flow	0.1s ~ 10s	Selection for gas flow time after the arc finishes.
5 Slow Feed	0 ~ 10	Selection for wire feed speed before arc start



15 Machine is ready to weld at optimum setting. If the welder is running too hot, adjusting the left knob back a little will also adjust the wire feed speed and Amps, all in 'Synergy' with each other.



16 Rotate right knob to trim the welding voltage. Press 2 times on the right knob for ΔU Delta Voltage; it's show the difference of the preset voltage programmed, rotate to adjust if necessary.

Press 1 time on the right knob for \sim Inductance; it works by creating a magnetic field which opposes the welding current in the short circuit thereby slowing the rate of rise. If the inductance is increased it will cause an increase in arc time and reduction in the dip frequency, this will help reduce spatter.

Ref MIG Welding Setting Guide on page 24-27

Settings	Adjustments
ΔU Delta Voltage	-4 ~ 4
\sim Inductance	0 ~ 10

Note: It is advisable to run a few test welds using scrap or offcut materials, in order to tune the machine to the correct settings prior to welding the job.

Note: Pictures may vary from your machine model

MIG MANUAL SETUP (GAS)

6 & 7. Fit gas regulator to bottle and install gas hose to the inlet on the back panel of welder. Turn on regulator and set gas flow to between 10-15 L/min depending on your welding environment

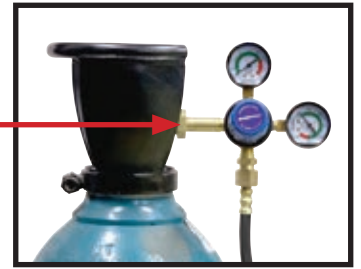

9. Select MIG Manual mode



4. Connect MIG Torch to the Euro Connection terminal
NOTE: Ensure connector nut is tighten firmly



4. Connect polarity switching cable to the **+** terminal

5. Connect earth clamp to the **-** terminal

IMPORTANT! - We strongly recommend that you check for gas leakage prior to operation of your machine. We recommend that you close the cylinder valve when the machine is not in use. BOSSWELD authorised representatives or agents of BOSSWELD will not be liable or responsible for the loss of any gas.



1 Plug the machine 10Amp input power lead into the wall socket, ensuring that the power switch on the machine is in the OFF position.

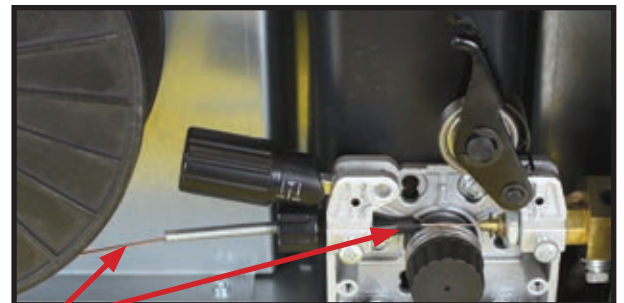

3 Set up the wire feed unit as per section "Set up Wire Feed Unit". Ref page 40

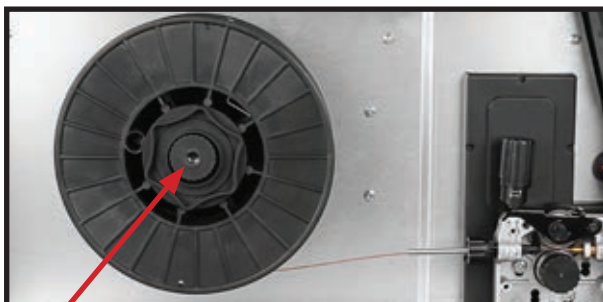

2 Open wire feed side panel and install **GAS** wire into machine ensuring the drive roller is matched to the wire size and type. Refer to Machine Drive Roller Size Guide on page 41
Note: Wire to roll from under spool into the wire guide inlet tube

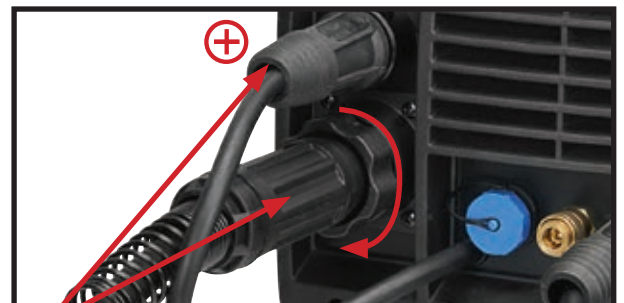

4 Install Euro connect MIG torch over the protruding wire, line up and screw the Euro connector nut up firmly. Ensure the polarity switching cable is plug into positive output connection socket for gas welding.

SETTING MACHINE POLARITY

DCEN - GASLESS		DCEP - GAS	
+	●	+	●
-	●	-	●

Note: Pictures may vary from your machine model

MIG MANUAL SETUP (GAS) CONTINUE



- 5** Fit the Earth lead Dinse Plug to the negative terminal for gas welding and then connect earth clamp to the work piece ensuring that the clamp makes good contact with bare metal.

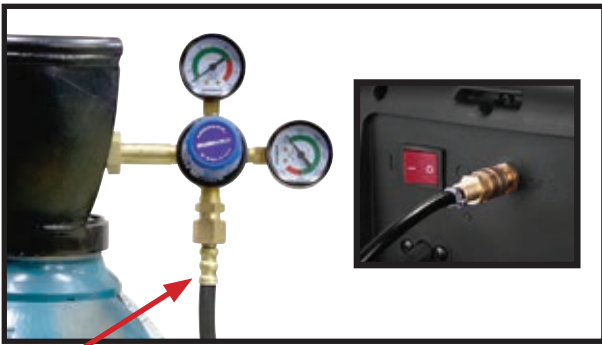

- 6** Fit gas regulator to the gas bottle and install gas hose to the gas inlet on the back panel of welder.

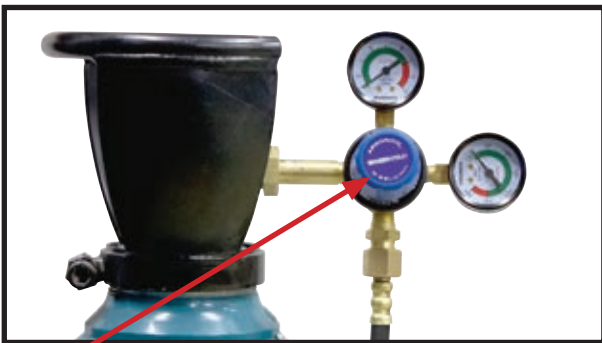

- 7** Turn on regulator and set gas flow to between 10-15 L/min depending on your welding environment.



- 8** Switch the machine **ON** using the mains power switch. Wait a few seconds whilst the machine powers up.



- 9** Press Menu button and adjust knob to select MIG Manual then press knob to confirm.

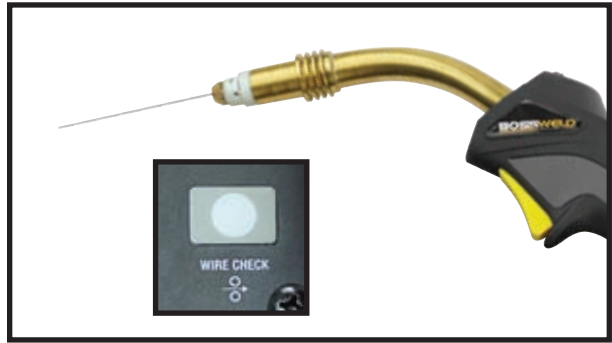

- 10** Remove nozzle and tip from torch and press wire feed button, this will feed the wire through the torch. Release button when wire appears at the end of the torch.



- 11** Re install tip and nozzle to torch and trim wire to the end of the nozzle.



- 12** Press 2T/4T button to select 2T or 4T mode. **2T Mode.** Press the gun/torch trigger to weld and release to stop. **4T Mode.** Press and release the gun/torch trigger to start, weld without holding the trigger on and stop by pressing and releasing the trigger again.

Note: Pictures may vary from your machine model

MIG MANUAL SETUP (GAS) CONTINUE



13 To adjust functions, press parameter button, rotate left knob for function selection and rotate right knob for adjustment then press parameter button again for confirmation.

Function	Setting	
1 Trigger	2T or 4T	Selection for 2T and 4T.
2 Burnback	0 ~ 10	Selection for the amount of wire to 'burn back' after release the torch trigger.
3 Pre-Flow	0.1s ~ 5s	Selection for gas flow time prior to the arc starting.
4 Post Flow	0.1s ~ 10s	Selection for gas flow time after the arc finishes.
5 Slow Feed	0 ~ 10	Selection for wire feed speed when welding

Note:
It is advisable to run a few test welds using scrap or offcut materials, in order to tune the machine to the correct settings prior to welding the job.



14 Rotate left knob to adjust wire feeding speed. Rotate right knob to adjust welding voltage.

Press 1 time on the right knob for Inductance; it works by creating a magnetic field which opposes the welding current in the short circuit thereby slowing the rate of rise. If the inductance is increased it will cause an increase in arc time and reduction in the dip frequency, this will help reduce spatter.

Function	Setting
m/min Wire Feeding Speed	1.5 ~ 18.0
U Welding Voltage	10.0 ~ 27.0
 Inductance	0 ~ 10

Ref MIG Welding Setting Guide on page 24-27

MIG MANUAL SET UP (GASLESS)

9. Select MIG Manual mode



6. Connect earth Clamp to the  terminal

4. Connect MIG Torch to the Euro Connection terminal
NOTE: Ensure connector nut is tighten firmly



5. Connect polarity switching cable to the  terminal

Note: Pictures may vary from your machine model

MIG MANUAL SETUP (GASLESS) CONTINUE



1 Plug the machine 10Amp input power lead into the wall socket, ensuring that the power switch on the machine is in the OFF position.

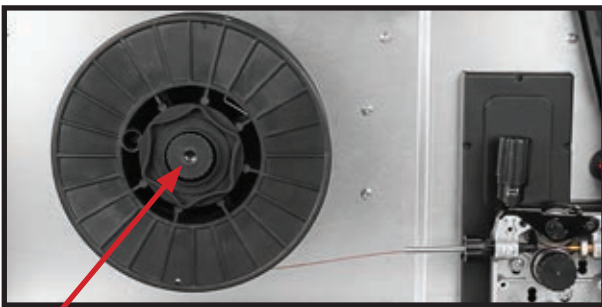

2 Open wire feed side panel & install **GASLESS** wire into machine ensuring the drive roller is matched to the wire size and type. Refer to Machine Drive Roller Size Guide on page 41
Note: Wire to roll from under spool into the wire guide inlet tube

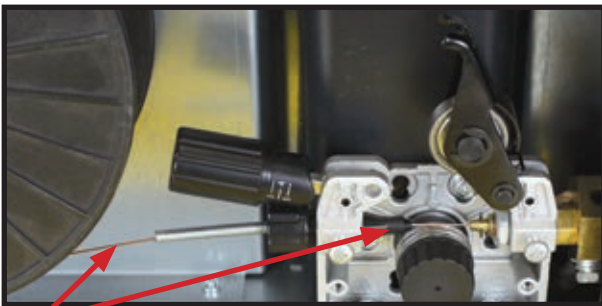

3 Set up the wire feed unit as per section "Set up Wire Feed Unit". Ref page 40

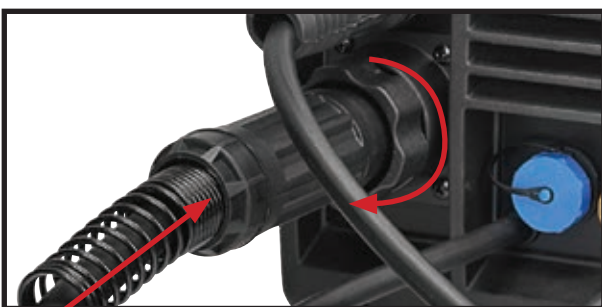

4 Install Euro connect MIG torch over the protruding wire, line up the spring connectors and screw the Euro connector nut up firmly.

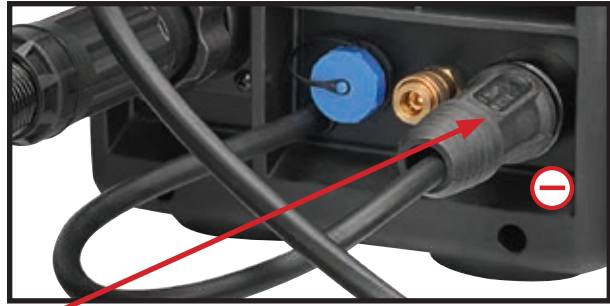

5 Ensure the polarity switching cable is plug into negative output connection socket for gasless welding

SETTING MACHINE POLARITY

DCEN - GASLESS

DCEP - GAS

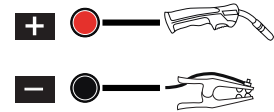
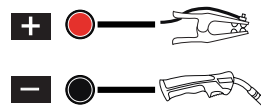

6 Fit the Earth lead Dinse Plug to the positive terminal for gasless welding and then connect earth clamp to the work piece ensuring that the clamp makes good contact with bare metal.



7 Switch the machine **ON** using the mains power switch. Wait a few seconds whilst the machine powers up.

8 Continue from MIG manual GAS set up page 17; step 9 to 14.

Note:
It is advisable to run a few test welds using scrap or offcut materials, in order to tune the machine to the correct settings prior to welding the job.

Note: Pictures may vary from your machine model

NOTE: SPOOL GUN IS NOT SUPPLIED WITH MACHINE - SEE PAGE 47 FOR TORCH OPTIONS
MIG MANUAL SPOOL GUN SETUP

14. Select MIG Manual mode



5 & 6. Fit gas regulator to bottle and install gas hose to the inlet on the back panel of welder. Turn on regulator and set gas flow to between 10-15 L/min depending on your welding environment

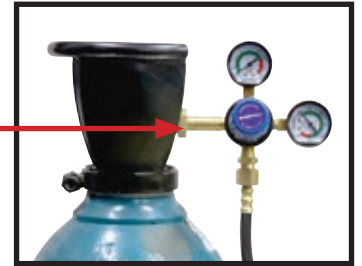

3. Connect polarity switching cable to the **+** terminal

2. Connect Spool Gun to the Euro Connection terminal
NOTE: Ensure connector nut is tighten firmly

3. Connect earth Clamp to the **-** terminal



IMPORTANT! - We strongly recommend that you check for gas leakage prior to operation of your machine. We recommend that you close the cylinder valve when the machine is not in use. BOSSWELD authorised representatives or agents of BOSSWELD will not be liable or responsible for the loss of any gas.



1 Plug the machine 10Amp input power lead into the wall socket, ensuring that the power switch on the machine is in the OFF position.

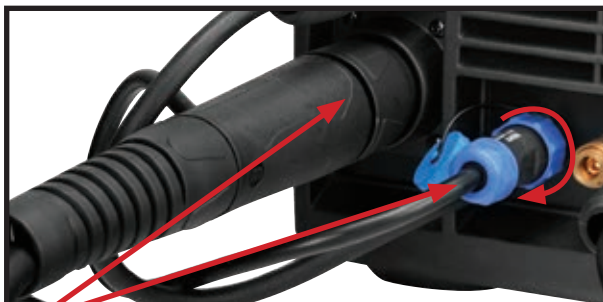

2 Install the Spool Gun to the machine by connecting Euro Connector and the Control Socket and screw the nut up firmly

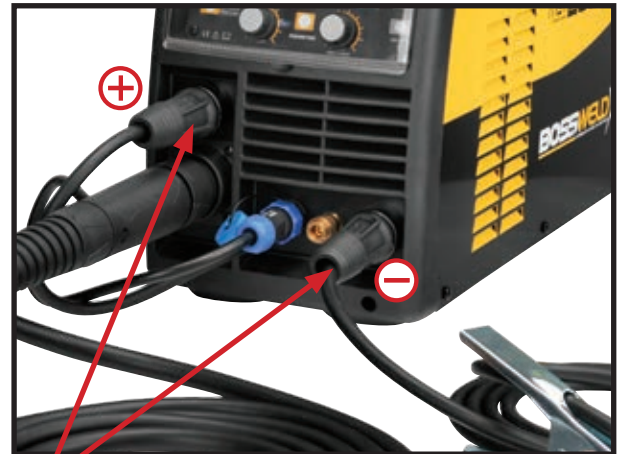

3 Fit the earth clamp to negative terminal and ensure the polarity switching cable is connect to positive output connection socket

SETTING MACHINE POLARITY

DCEN - GASLESS	DCEP - GAS
+	+
-	-

Note: Pictures may vary from your machine model

MIG MANUAL SPOOL GUN SETUP CONTINUED



- 4 Connect earth clamp to the work piece ensuring that the clamp makes good contact with bare metal.

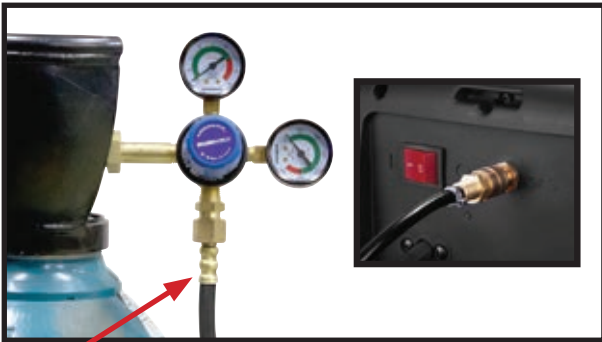

- 5 Fit gas regulator to the gas bottle and install gas hose to the gas inlet on the back panel of welder.

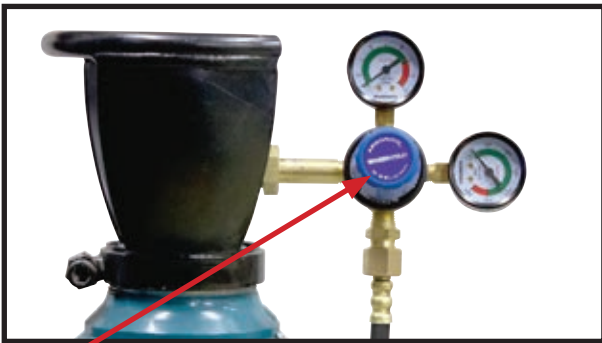

- 6 Turn on regulator and set gas flow to between 10-15 L/min depending on your welding environment.

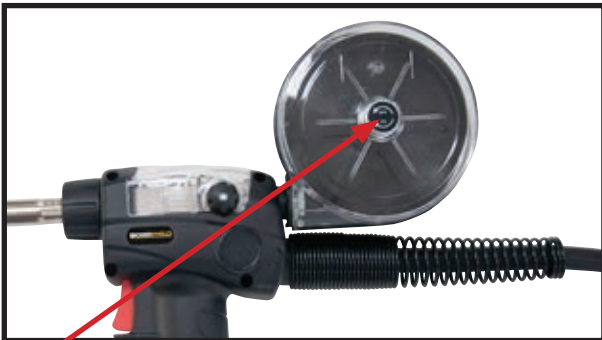

- 7 Open wire cover panel by loosening the retaining nut and removing the cover

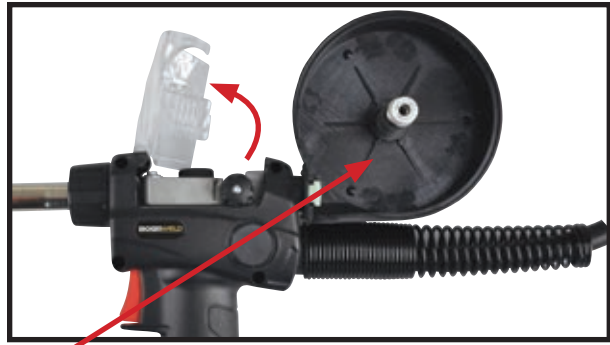

- 8 Remove the spool cover and lift wire drive cover

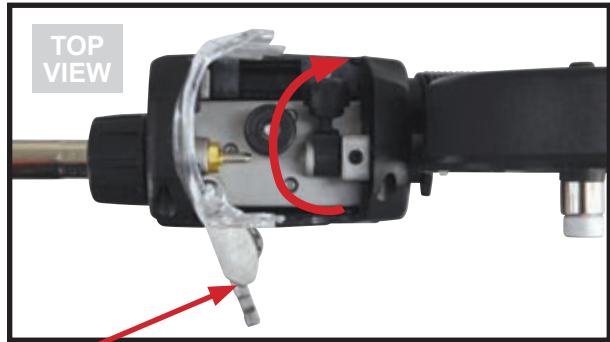

- 9 Release the wire tensioning arm, and check the correct drive roller size matches the wire being used



- 10 Feed the wire over the drive roller and into the inlet guide, make sure you hold the spool to stop it unraveling.

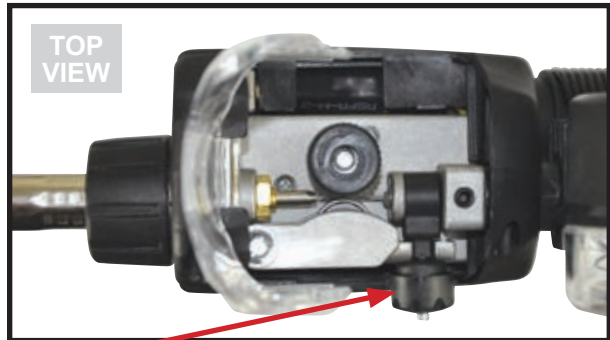

- 11 Re-latch the tensioning arm, making sure you still hold the spool to stop it unraveling. Screw in to increase tension.

Note: Pictures may vary from your machine model

MIG MANUAL SPOOL GUN SETUP CONTINUED



12 Replace the spool cover and close the wire drive cover



13 Switch the machine **ON** using the mains power switch. Wait a few seconds whilst the machine powers up.



14 Press Menu button and adjust knob to select MIG Manual then press knob to confirm

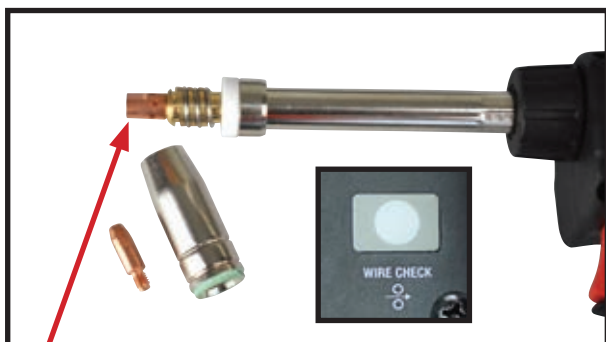

15 Remove nozzle and tip from torch and press wire feed button, this will feed the wire through the torch. Release trigger when wire appears at the end of the torch.

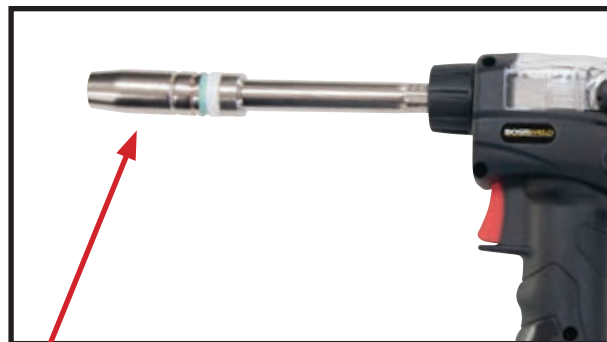

16 Re install tip and nozzle to torch and trim wire to the end of the nozzle.



17 Press 2T/4T button to select 2T or 4T mode.

2T Mode. Press the gun/torch trigger to weld and release to stop. **4T Mode.** Press and release the gun/torch trigger to start, weld without holding the trigger on and stop by pressing and releasing the trigger again.



18 To adjust functions, press parameter button, rotate left knob for function selection and rotate right knob for adjustment then press parameter button again for confirmation. Turn the spool gun selection ON.

Function	Setting	
1 Trigger	2T or 4T	Selection for 2T and 4T.
2 Burnback	0 ~ 10	Selection for the amount of wire to 'burn back' after release the torch trigger.
3 Pre-Flow	0.1s ~ 5s	Selection for gas flow time prior to the arc starting.
4 Post Flow	0.1s ~ 10s	Selection for gas flow time after the arc finishes.
5 Slow Feed	0 ~ 10	Selection for wire feed speed when welding
6 Spool Gun	ON or OFF	Switch for Spool Gun

Note: Pictures may vary from your machine model

MIG MANUAL SPOOL GUN SETUP CONTINUED



Ref MIG Welding Setting Guide on page 24-27

Function		Setting
m/min	Wire Feeding Speed	1.5 ~ 16.0
U	Welding Voltage	10.0 ~ 27.0
	Inductance	0 ~ 10

- 19** Rotate left knob to adjust wire feeding speed.
 Rotate right knob to adjust welding voltage.
 Press 1 time on the right knob for Inductance; it works by creating a magnetic field which opposes the welding current in the short circuit thereby slowing the rate of rise. If the inductance is increased it will cause an increase in arc time and reduction in the dip frequency, this will help reduce spatter.

Note:
 It is advisable to run a few test welds using scrap or offcut materials, in order to tune the machine to the correct settings prior to welding the job.

MIG MANUAL SPOOL GUN SET UP (GASLESS)



- 1** Plug the machine 10Amp input power lead into the wall socket, ensuring that the power switch on the machine is in the OFF position.



- 2** Ensure the polarity switching cable is plug into negative output connection socket for gasless welding

SETTING MACHINE POLARITY

DCEN - GASLESS		DCEP - GAS	

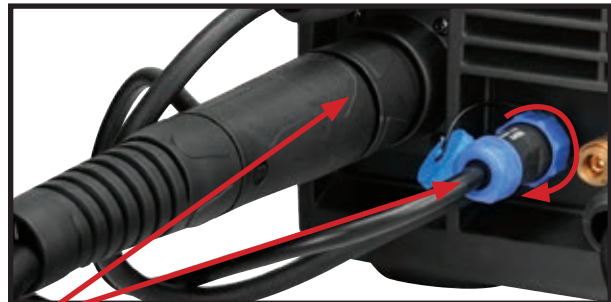

- 3** Install the Spool Gun to the machine by connecting Euro Connector and the Control Socket and screw the nut up firmly



- 4** Fit the Earth lead Dinse Plug to the positive terminal for gasless welding and then connect earth clamp to the work piece ensuring that the clamp makes good contact with bare metal.

- 5** Continue from MIG manual spool gun set up page 21; step 7 to 19.

Note: Pictures may vary from your machine model

BASIC MIG WELDING GUIDE

The welding power supply has two control settings that have to balance. These are voltage control switches and the wire speed control. The welding amperage is determined by the voltage settings, the wire diameter, gas selection and the wire feed speed. The amperage will increase with higher voltage selection on the machine and higher wire feed speed. This is typically used for welding thick sections of steel. When welding thin sections of steel, a lower voltage selection and lower wire feed speed is required.

- When changing to a different wire diameter different control settings are required. A thinner wire needs more wire speed to achieve the same current level.
- A satisfactory weld cannot be obtained if the wire speed and voltage switch settings are not adjusted to suit the wire diameter and thickness of the material being welded.
- If the wire speed is too high for the welding voltage, “stubby” will occur as the wire dips into the molten pool. If the wire speed is too slow for the welding voltage, large drops will form on the end of the electrode wire, causing spatter. Suppose that wire speed is constant, if the welding voltage is too high, large drops will form on the end of the electrode wire, causing spatter; if the voltage is too low, the wire will not melt.

POSITION OF MIG GUN

The angle of MIG gun to the weld has an effect on the width of the weld run.

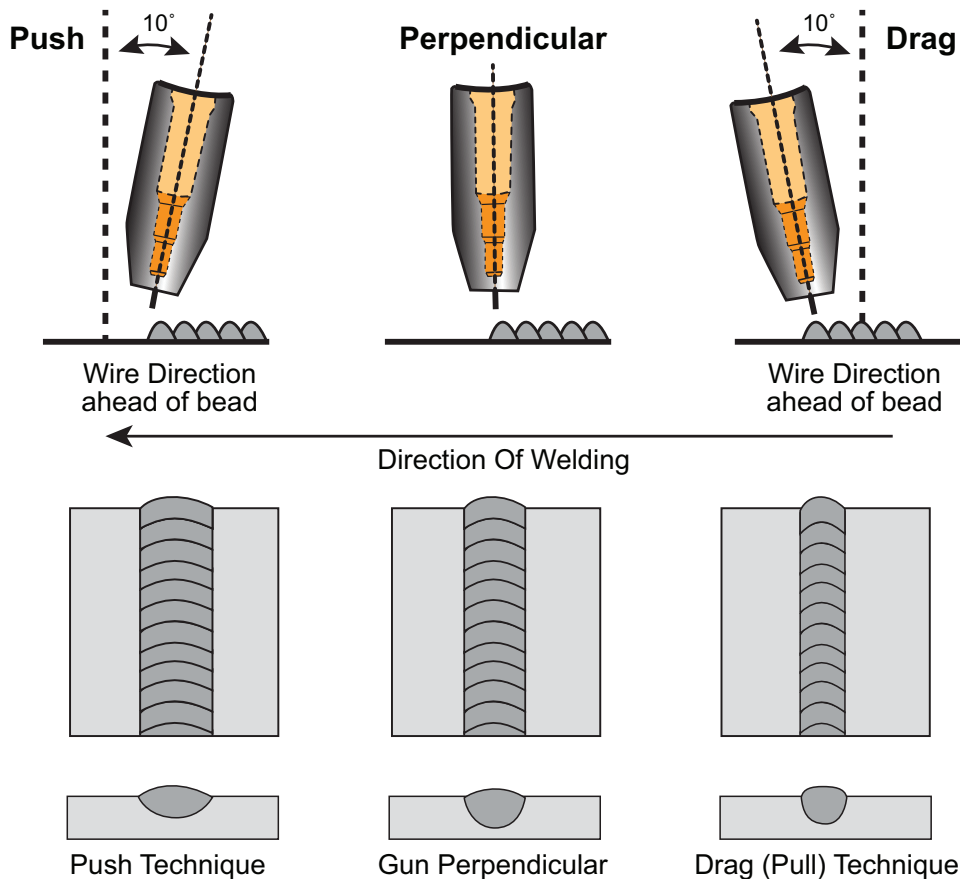

Distance from the MIG Gun Nozzle to the Work Piece

The electrode stick out from the MIG gun nozzle should be between 2.0mm to 5.0mm when welding with gas shielded wire. An increased distance of 5mm to 10mm is required when welding with Gasless wire. This distance will vary depending on the type of joint that is being weld. .

Travel Speed

Speed at which a weld travels influences the width of the weld and penetration of the welding run. Welding thin steel will have a faster travel speed than welding thick steel.

Wire Size Selection

The choice of wire size in conjunction with shielding gas used depends on:

- Thickness of the metal to be welded.
- Type of joint configuration
- Capacity of the wire feed unit and power supply.
- The amount of penetration required.
- The deposition rate required.
- The bead profile desired
- The position of welding and cost of the wire.
- Location of welding

Metal inert gas (MIG) welding is an attractive alternative to MMA (stick welding), offering high deposition rates and high productivity.

PROCESS CHARACTERISTICS

MIG welding is a versatile technique suitable for both thin sheet and thick section components. An arc is struck between the end of a wire electrode and the workpiece, melting both of them to form a weld pool. The wire serves as both heat source (via the arc at the wire tip) and filler metal for the joint. The wire is fed through a copper contact tube (contact tip) which conducts welding current into the wire. The weld pool is protected from the surrounding atmosphere by a shielding gas fed through a nozzle surrounding the wire. Shielding gas selection depends on the material being welded and the application. The wire is fed from a reel by a motor drive, and the welder moves the welding torch along the joint line. Wires may be solid (simple drawn wires), or cored (composites formed from a metal sheath with a powdered flux or metal filling). Consumables are generally competitively priced compared with those for other processes. The process offers high productivity, as the wire is continuously fed.

Manual MIG welding is often referred as a semi-automatic process, as the wire feed rate and arc length are controlled by the power source, but the travel speed and wire position are under manual control. The process can also be mechanised when all the process parameters are not directly controlled by a welder, but might still require manual adjustment during welding. When no manual intervention is needed during welding, the process can be referred to as automatic. The process usually operates with the wire positively charged and connected to a power source delivering a constant voltage. Selection of wire diameter (usually between 0.6 and 1.6mm) and wire feed speed determine the welding current, as the burn-off rate of the wire will form an equilibrium with the feed speed.

BASIC MIG WELDING GUIDE - CONTINUE

SHIELDING GAS

In addition to general shielding of the arc and the weld pool, the shielding gas performs a number of important functions:



- forms the arc plasma
- stabilises the arc roots on the material surface
- ensures smooth transfer of molten droplets from the wire to the weld pool

The shielding gas will have a substantial effect on the stability of the arc and metal transfer and the behaviour of the weld pool, in particular, its penetration. General purpose shielding gases for MIG welding are mixtures of argon, oxygen and CO₂, and special gas mixtures may contain helium.

The gases which are normally used for the various materials are:

- Steels: CO₂, argon +2 to 5% oxygen, argon +5 to 25% CO₂.
- Non-ferrous (e.g. Aluminium, copper or nickel alloys): Argon, argon / helium.

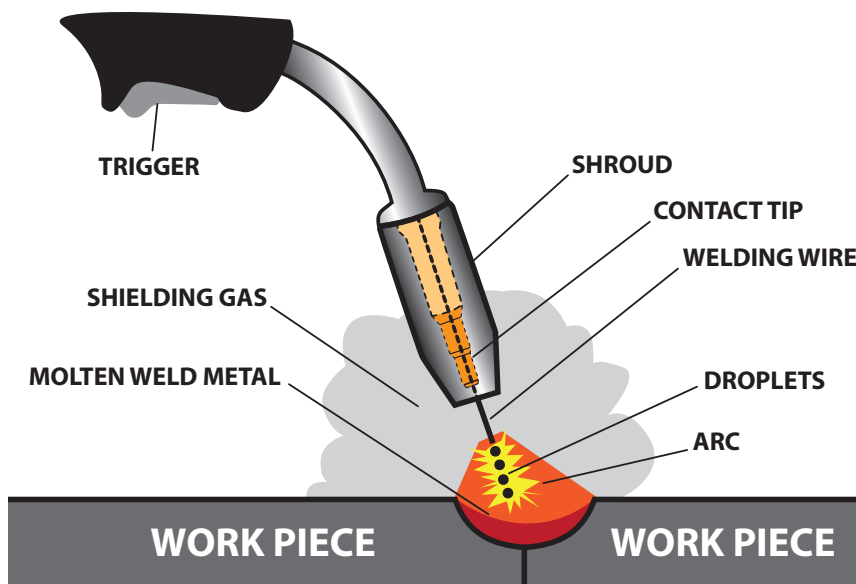

Argon based gases, compared with CO₂, are generally more tolerant to parameter settings and generate lower spatter levels with the dip transfer mode. However, there is a greater risk of lack of fusion defects because these gases are colder. As CO₂ cannot be used in the open arc (pulsed or spray transfer) modes due to high back-plasma forces, argon based gases containing oxygen or CO₂ are normally employed.

WELDING GAS SELECTION CHART GUIDE		
 MIG MIG WELDING	 ARGON	 Ar-CO₂-O₂
	MILD STEEL	X
STAINLESS STEEL	X	✓
LOW ALLOY STEEL	X	✓
GALVANISED STEEL	X	✓
ALUMINIUM	✓	X

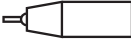

SETTING GUIDE FOR WELDING WITH MST 200X4

Material Thickness	Steel													
	 DC (+)													
	Solid													
	80% Argon 20% CO ₂							100% CO ₂						
	Ø 0.6mm		Ø 0.8mm		Ø 0.9mm		Ø 1.0mm		Ø 0.8mm		Ø 0.9mm		Ø 1.0mm	
m/min	V	m/min	V	m/min	V	m/min	V	m/min	V	m/min	V	m/min	V	
0.8mm	5.5	14.0	3.0	14.5	-	-	-	-	-	-	-	-	-	
1.0mm	6.7	14.8	3.6	15.0	2.9	14.3	-	-	3.4	16.0	3.5	17.0	-	
1.2mm	8.1	15.3	4.4	15.6	3.7	14.8	14.0	14.0	3.8	16.5	4.1	17.7	3.0	16.5
1.6mm	9.5	17.0	5.1	16.3	4.3	16.4	14.8	14.8	4.8	17.3	4.6	18.6	3.4	17.0
2.0mm	11.0	18.5	5.5	16.8	4.9	16.8	14.5	14.5	6.0	18.1	5.1	19.0	3.7	17.2
3.0mm	14.0	20.0	6.8	18.0	6.8	19.0	15.8	15.8	6.8	18.8	6.3	19.8	14.5	17.9
5.0mm	-	-	10.0	19.5	9.5	21.8	18.4	18.4	8.3	20.4	9.2	22.2	6.7	20.8
6.0mm	-	-	12.5	20.5	10.8	22.4	20.5	20.5	14.0	23.4	11.1	24.1	8.3	23.5
8.0mm	-	-	15.3	23.8	12.8	26.8	24.5	24.5	15.8	24.5	-	-	10.4	26.5

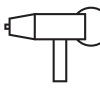
Material Thickness	Stainless						Steel						Aluminium			
	 DC (+)						 DC (-)						 DC (+)			
	Solid						Cored									
	98% Argon 2% CO ₂						No Gas for Inner Shield Wires						100% Argon			
	Ø 0.8mm		Ø 0.9mm		Ø 1.0mm		Ø 0.8mm		Ø 0.9mm		Ø 1.0mm		Ø 1.0mm		Ø 1.0mm	
m/min	V	m/min	V	m/min	V	m/min	V	m/min	V	m/min	V	m/min	V	m/min	V	
0.8mm	-	-	-	-	-	-	-	-	-	-	-	-	-	-	-	
1.0mm	4.6	14.2	-	-	-	-	5.1	15.0	5.0	17.4	-	-	-	-	-	
1.2mm	6.3	15.7	4.8	15.1	4.1	15.1	6.0	15.3	5.8	17.9	4.8	17.3	-	7.0	16.4	
1.6mm	8.3	16.7	5.8	16.0	5.0	16.1	7.4	17.3	7.0	18.6	5.3	17.5	7.0	17.0	9.0	17.6
2.0mm	9.4	17.4	7.0	17.2	5.9	16.7	8.7	19.5	8.1	19.2	6.1	18.0	8.3	17.4	11.0	18.4
3.0mm	12.5	18.6	9.7	18.8	8.2	18.3	12.0	21.5	10.7	21.9	7.6	19.0	10.3	19.3	15.0	19.8
5.0mm	-	-	-	-	12.6	22.2	-	-	14.2	24.4	11.2	22.4	13.3	23.0	16.0	21.0
6.0mm	-	-	-	-	14.2	23.7	-	-	-	-	12.5	23.2	-	-	-	-
8.0mm	-	-	-	-	-	-	-	-	-	-	-	-	-	-	-	-

TIG SET UP

6 & 7. Fit gas regulator to bottle and install gas hose to the inlet on the back panel of welder. Turn on regulator and set gas flow to between 10-15 L/min depending on your welding environment

10. Select TIG LIFT OR HF Start mode

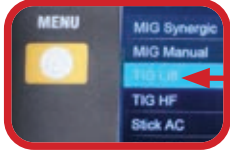

5. Connect earth Clamp to the **(+)** terminal

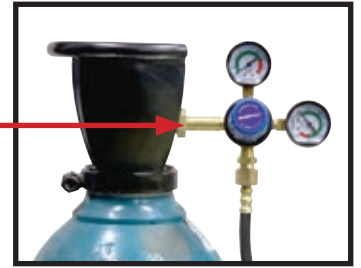

2. Connect TIG Torch Control Socket and screw the nut up firmly

2. Connect the Gas hose to the Gas Output

2. Connect TIG Torch to the **(-)** terminal



1 Plug the machine 10Amp input power lead into the wall socket, ensuring that the power switch on the machine is in the OFF position.



3 Set up the TIG torch. Ensure collect body, collet with back cap are screw in firmly.

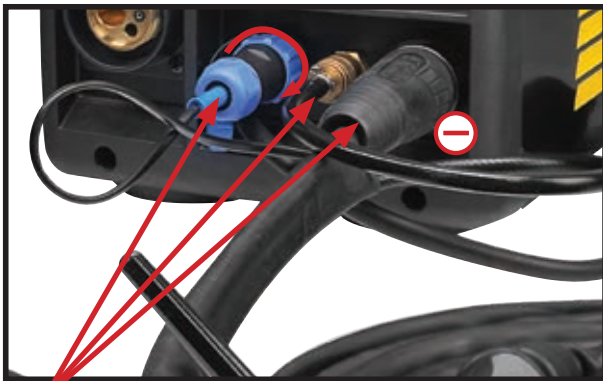

2 Install the TIG Torch to the machine by connecting the Dinse Connector to the Negative Output Connection Socket, the Gas hose to the Gas Output and the TIG Torch Control Socket and screw the nut up firmly.

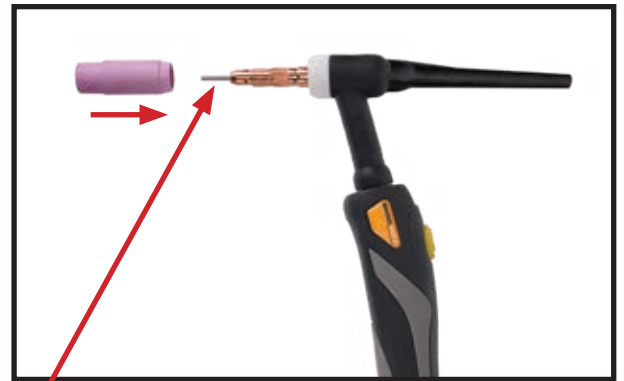

4 Place the Tungsten Electrode into the torch head then screw in alumina cap.

Note: Pictures may vary from your machine model

TIG SET UP - CONTINUED

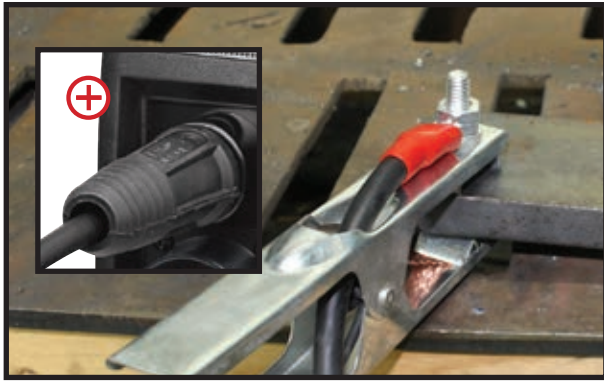

- 5 Fit the Earth lead Dinse Plug to the positive terminal for gas welding and then connect earth clamp to the work piece ensuring that the clamp makes good contact with bare metal.

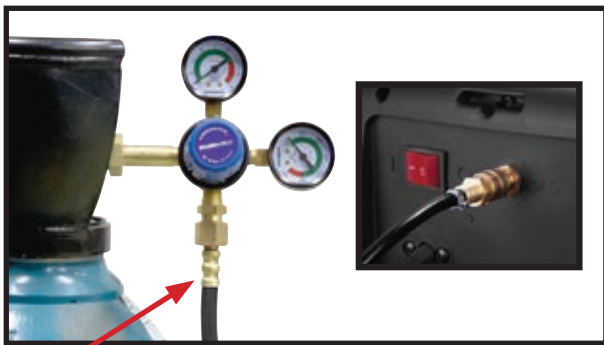

- 6 Fit gas regulator to the gas bottle and install gas hose to the gas inlet on the back panel of welder.



- 7 Turn on regulator and set gas flow to between 10-15 L/min depending on your welding environment.

IMPORTANT! - We strongly recommend that you check for gas leakage prior to operation of your machine. We recommend that you close the cylinder valve when the machine is not in use. BOSSWELD authorised representatives or agents of BOSSWELD will not be liable or responsible for the loss of any gas.

Note: Pictures may vary from your machine model



- 13 Switch the machine ON using the mains power switch. Wait a few seconds whilst the machine powers up.



- 9 Press 2T/4T button to select 2T or 4T mode. **2T Mode.** Press the gun/torch trigger to weld and release to stop. **4T Mode.** Press and release the gun/torch trigger to start, weld without holding the trigger on and stop by pressing and releasing the trigger again.



- 10 Press MENU and adjust knob to select TIG Lift or HF mode then press knob to confirm.

TIG Lift is a method of starting the arc when TIG welding that enables the operator to touch the tungsten to the work piece, lift it off the work piece, and then have full welding current begin flowing.

TIG HF (high frequency ignition) allows the operator to position the tungsten electrode near the job, and simply press the torch trigger to start the arc.

Ref Lift Arc Start and HF Arc Start Guide on page 32

TIG SET UP - CONTINUED



For NO Pulse Welding

11A

To adjust functions, press parameter button, rotate left knob for function selection and rotate right knob for adjustment then press parameter button again for confirmation.

Ref Pulse TIG Welding Guide on page 36



For Pulse Welding

11B

Pulse TIG welding is most commonly used to weld thin sections of stainless steel, non-ferrous metals such as aluminum, magnesium and copper alloys. It is comparatively more complex in functions.

To adjust functions, press parameter button, rotate left knob for function selection and rotate right knob for adjustment then press parameter button again for confirmation.

Ref Pulse TIG Welding Guide on page 36

Function	Setting	
1 AC/DC	AC: Sine, Square & Triangle DC	DC AC AC AA AC AA
2 Pulse Weld	On or off (TIG HF: Spot)	Selection for Pulse, No Pulse or Spot
3 Trigger	2T or 4T	Selection for 2T and 4T
4 Pre-Flow	0.0s ~ 2.0s	Selection for gas flow time prior to the arc starting
5 Pre Current	10A ~ 200A	Selection for the amount of amps required at the start of the weld
6 Up Slope	0.0s ~ 10.0s	Selection for the transition time from Start Amperage to Peak Amperage
7 Welding Current	10A ~ 200A	Selection for the current that flows through a circuit while a weld is being made.
8 Down Slope	0s ~ 10s	Selection for the transition time from Peak Amperage to Finish Amperage
9 Post Current	10A ~ 200A	Selection for the amount of amps required at the end of the weld
10 Post Flow	0s ~ 10s	Selection for gas flow time after the arc finishes



Direct current TIG (DC) welding is when the current flows in one direction only. Compared with AC (Alternating Current) TIG welding the current once flowing will not go to zero until welding has ended.

DC is used for TIG welding Mild Steel/Stainless material and AC would be used for welding Aluminium.

Ref AC / DC Welding Guide on page 34-35

Function	Setting	
1 AC/DC	AC: Sine, Square & Triangle DC	DC AC AC AA AC AA
2 Pulse Weld	On or off (TIG HF: Spot)	Selection for Pulse, No Pulse or Spot
3 Trigger	2T or 4T	Selection for 2T and 4T
4 Pre-Flow	0.0s ~ 2.0s	Selection for gas flow time prior to the arc starting
5 Pre Current	10A ~ 200A	Selection for the amount of amps required at the start of the weld
6 Up Slope	0.0s ~ 10.0s	Selection for the transition time from Start Amperage to Peak Amperage
7 Peak Current	10A ~ 200A	Selection for the Maximum Welding Amperage required during welding
8 Base Current	10A ~ 200A	Selection for the Base Welding Amperage required during welding
9 Pulse Frequency	0.5Hz ~ 999Hz	Selection for the frequency with which the welding amperage goes from peak amperage to a basic current in a second
10 Duty Cycle	5% ~ 95%	Selection for the percentage of time for safely operate
11 Down Slope	0s ~ 10s	Selection for the transition time from Peak Amperage to Finish Amperage
12 Post Current	10A ~ 200A	Selection for the amount of amps required at the end of the weld
13 Post Flow	0s ~ 10s	Selection for gas flow time after the arc finishes



For Spot Welding

11C Spot welding is quick and easy and creates a strong joint. It doesn't use any flux or filler metal, so there is no need to grind excess slag when finished, and there is no dangerous open flame.

It can only create localized joints and can be challenging to join oddly shaped pieces of metal.

To adjust functions, press parameter button, rotate left knob for function selection and rotate right knob for adjustment then press parameter button again for confirmation.

Function	Setting	
1 AC/DC	AC: Sine, Square & Triangle DC	DC AC 𠄎 AC AA AC AA Selection and DC output or AC wave output
2 Pulse Weld	On or off (TIG HF: Spot)	Selection for Pulse, No Pulse or Spot
3 Pre-Flow	0.1s ~ 2.0s	Selection for gas flow time prior to the arc starting
4 Welding Current	10A ~ 200A	Selection for the current that flows through a circuit while a weld is being made.
5 Time on	0.2s ~ 1.0s	The amount of time welding, to ensure welds are the same size and or length.
6 Time off	0s ~ 10s	The time between welds, to allow to move the torch position to new location / stitch weld.
7 Post Flow	0.1s ~ 10s	Selection for gas flow time after the arc finishes

Note:
It is advisable to run a few test welds using scrap or offcut materials, in order to tune the machine to the correct settings prior to welding the job.



For DC Welding

12A Rotate left knob to adjust welding current. Rotate right knob to adjust the welding voltage. Ref AC / DC Welding Guide on page 34-35



For AC Welding

12B Rotate left knob to adjust welding current. Rotate right knob to adjust the welding voltage. Press one time on the right knob for **AC Balance**; this control allows the operator to adjust the balance between the penetration (EN) and cleaning action (EP) portions of the cycle.

It produces a greater cleaning action to remove heavy oxidation and minimizes penetration, which may help prevent burn-through on thin materials. Reducing the EN cycle, however, decreases tungsten electrode life and increases balling action because more heat is being directed into the electrode. This creates a large ball at the end of the tungsten and causes the arc to lose stability, making it hard to direct the arc weld puddle.

Press two times on the right knob for **AC Frequency**; it controls the width of the arc cone. Increasing the AC frequency provides a more focused arc with increased directional control. Decreasing the AC frequency softens the arc and broadens the weld puddle for a wider weld band.

Ref AC / DC Welding Guide on page 34-35

Function	Setting
AC Balance	-5 ~ 5
AC Frequency	50 ~ 250Hz

LIFT ARC START

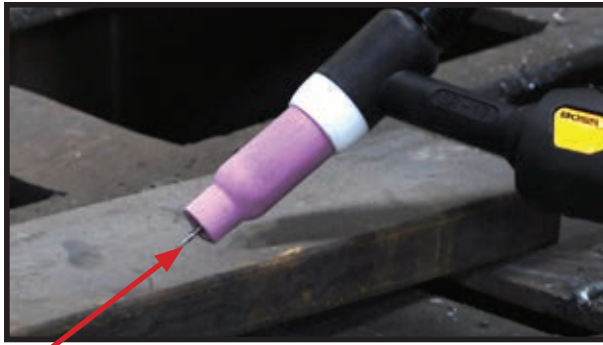

1 Lay the outside edge of the Gas Cup on the work piece with the Tungsten Electrode 1- 2mm from the work piece.

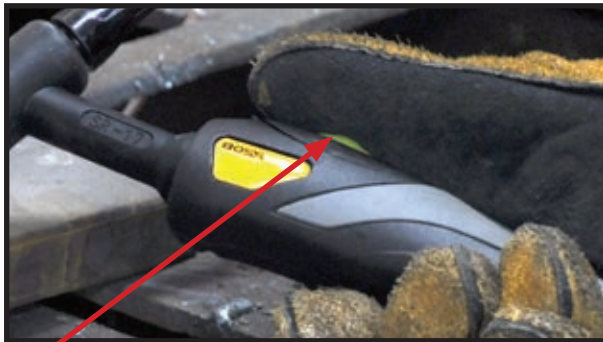

2 Press the button on the TIG torch

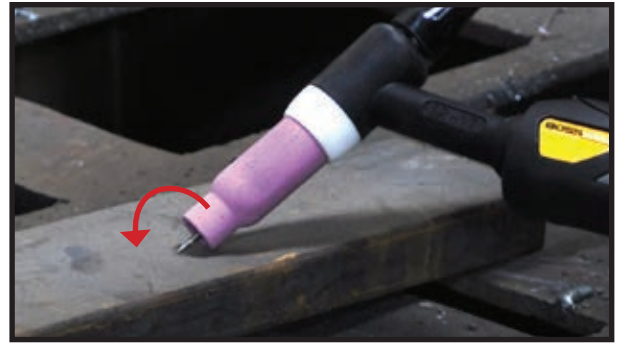

3 With a small movement rotate the Gas Cup forward so that the Tungsten Electrode touches the work piece.



4 Now rotate the Gas Cup in the reverse direction to lift the Tungsten electrode from the work piece to create the arc.

HF ARC START

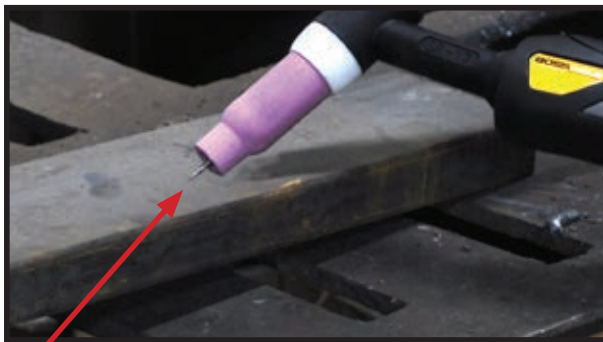

1 Lay the outside edge of the Gas Cup on the work piece with the Tungsten Electrode 1- 2mm from the work piece.



2 Press the button on the TIG torch



3 The Arc will start forming an arc between the tungsten tip and the work piece

TUNGSTEN PREPARATION & GRINDING

Caution: Grinding can create a hazard as the exposed tungsten/thoria area is greatly increased and fine particles of dust are released into the atmosphere. It is recommended that a dedicated grindstone with local dust extraction is used, and a simple filter mask is worn. If the grinding wheel is not fitted with a protective viewing screen, eye protection must be worn.

CORRECT PREPERATION - STABLE ARC

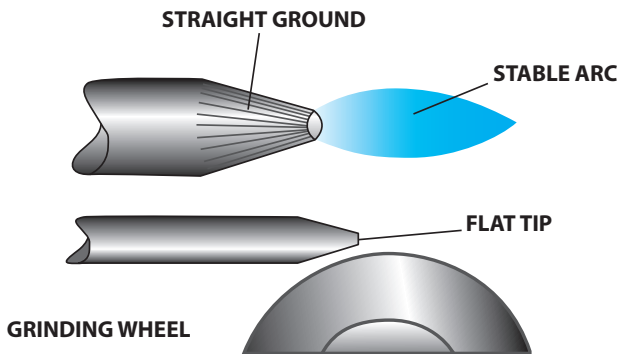

INCORRECT PREPERATION - STABLE ARC

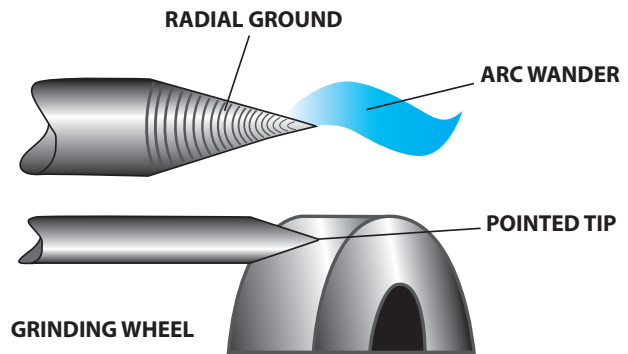

Note: Do not use wheel for other jobs or tungsten can become contaminated and cause lower weld quality

FOOT CONTROL - OPTIONS

Bossweld Foot Control 3mt

Part No: 660201



3 metre cord Ideal for bench work Parent-Child relationship between the welder and foot controller. This means if you set the welder to 120 Amps, the foot controller range will be between min and 120 Amps.

Bossweld 12-9 Plug Adaptor

Part No: 95.PA1209

This plug adaptor must be used with the Bossweld foot controller (P/N-660201), when used with the MST 200X4.

The adaptor also allows the Bossweld TIG torches with 12 pin plugs to be used with the MST 200X4.



BASIC TIG WELDING GUIDE

PROCESS CHARACTERISTICS

In the TIG process the arc is formed between a pointed tungsten electrode and the workpiece in an inert atmosphere of argon. The small intense arc provided by the pointed electrode is ideal for high quality and precision welding. Because the electrode is not consumed during welding, the welder does not have to balance the heat input from the arc as the metal is deposited from the melting electrode. When filler metal is required, it must be added separately to the weldpool.

POWER SOURCE

TIG must be operated with a constant current power source. A constant current power source is essential to avoid excessively high currents being drawn when the electrode is short-circuited onto the workpiece surface. This could happen either deliberately during arc starting or inadvertently during welding. If, as in MIG welding, a flat characteristic power source is used, any contact with the workpiece surface would damage the electrode tip or fuse the electrode to the workpiece surface. In DC, because arc heat is distributed approximately one-third at the cathode (negative) and two-thirds at the anode (positive), the electrode is always negative polarity to prevent overheating and melting. However, the alternative power source connection of DC electrode positive polarity has the advantage in that when the cathode is on the workpiece, the surface is cleaned of oxide contamination.

APPLICATIONS

TIG is applied in all industrial sectors but is especially suitable for high quality welding. In manual welding, the relatively small arc is ideal for thin sheet material or controlled penetration (in the root run of pipe welds). Because deposition rate can be quite low (using a separate filler rod) MMA or MIG may be preferable for thicker material and for fill passes in thick-wall pipe welds.

WELDING GAS SELECTION CHART GUIDE		
 TIG TIG WELDING	ARGON	Ar-CO ₂ -O ₂
	MILD STEEL	✓
STAINLESS STEEL	✓	✗
LOW ALLOY STEEL	✓	✗
ALUMINIUM	✗	✓

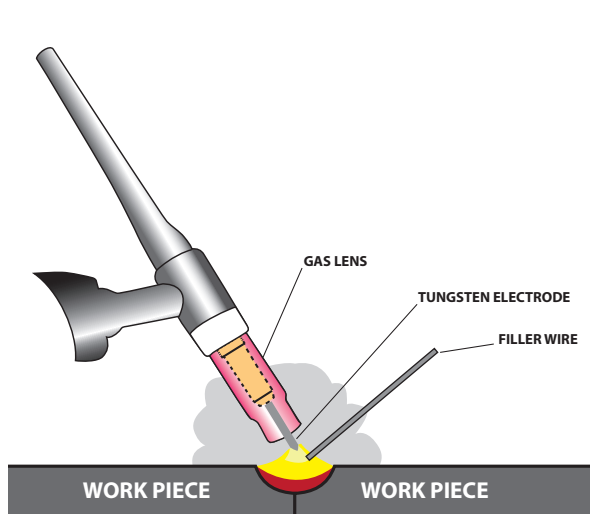

AC / DC WELDING

Alternating current (AC) is electricity that switches direction back and forth so the voltage also periodically reverses because the current changes direction. Typical AC currents are what you would expect to see from your electrical outlets in your home and often used in higher voltage devices such as household appliances. AC current changes its polarity 120 times per second with a 60-hertz current. Reversed polarity (AC) results in deeper penetration. In Alternate Current (AC) welding, since the current and the magnetic field of the arc reverse direction many times a second, there is no net deflection of the arc.

Applications of AC Welding

AC welding can be used to weld magnetic metals. This cannot be done with DC welding. AC welding is ideal for the following types of welds:

- Downhand heavy plate
- Fast fill
- Aluminum TIG welding with high frequency

The primary advantage of using AC welding is that it allows the weld operator to weld on magnetized materials. In AC current, the current changes direction and is not affected by magnetism. The arc remains stable and is easier to control.



AC welding is also the preferred method for:

- TIG welding aluminum, because the current supports welding at a higher temperature.
- Making repairs on machinery because the machinery usually has a magnetized field and is older and may have rusty areas where there is concern about the higher heat penetration that can occur with DC welding.
- Seam welding in shipbuilding because the current settings can often be higher than those used in DC welding and a deeper penetration of plate metals can be obtained.

The biggest drawback to using AC welding is the quality of the weld. It is not as smooth as DC welding because of the continuous change in directional flow and there is likely to be more spatter.

Different waveforms for AC welding on TIG welding machines

There will be different waveforms depending on the parameter settings. This gives the welder even more precise control of the weld pool and the seam's appearance. The flickering of the pulse arc can also be affected, reducing the stress on the welder's eyes in the process. There are also acoustic differences as noise is reduced.

AC 	AC 	AC 
Waveform: Hard rectangle	Waveform: Soft rectangle	Waveform: Triangle
<p>Switching between the plus and minus pole is very fast.</p> <p>Effect: The goal is an extremely fast zero crossing of the half-wave. The arc becomes highly stable while a very loud, "hard" arc noise is produced at the same time.</p> <p>Applications: This "hard" arc is still the standard today for many welders as they have always been used to it and it offers good welding properties. There is also the advantage that the arc can be used on very thick oxide layers.</p>	<p>The switching between plus and minus is therefore not quite as abrupt as it is with the hard rectangle function, and not as delayed as in sine mode.</p> <p>Effect: The arc combines the advantage of the sine and the hard rectangle modes. The result is a relatively stable arc, with relatively low/quiet background noise.</p> <p>Applications: Due to these properties, the option "soft rectangle" for TIG welding systems is also the universal setting— for a wide range of welding tasks.</p>	<p>The variation of the current between plus and minus is distributed entirely evenly over time.</p> <p>Effect: The zero crossing is therefore rather slow in comparison to the other waveforms. However, the even distribution of the current-time area achieves a higher peak current, although the mean current remains the same. This in turn results in a particularly high arc pressure. Acoustically, the arc is only slightly louder than the sine setting.</p> <p>Applications: The high arc pressure means the triangle setting is particularly well suited for root passes.</p>

Applications of DC Welding

Welding with DC is best used for:

- Hard facing
- Build-up of heavy deposits
- Overhead or vertical welding
- Stainless steel TIG welding
- Single carbon brazing
- Cutting tap

As a rule of thumb, DC is preferred for welding because:

It produces a smoother weld and there is less spatter because of the constant linear direction of the current. It maintains a constant and stable arc and is thus easier to handle and more reliable than AC current. Machinery that uses DC current is generally cheaper and easier to use. It welds thinner metals better than AC current.

Overall Strength of Welds

Overall the strength of the weld can be determined by many factors, such as:

- Proper electrode, welding apparatus and procedures;
- Properties of the materials being welded-magnetic vs. non-magnetic;
- Proper edge preparation-the cleaner the edge, the better the weld;
- Current settings – DC vs. AC;
- Speed of travel – the angle of the electrode needs to be maintained throughout the length of the joint as it is being welded.

A strong weld can be achieved in both AC welding and DC welding so long as you weld with the current and polarity appropriate for the material being welded. One doesn't necessarily, always and everywhere, produce a better weld than the other. It's a matter of choosing the right one for your job.

PULSE TIG WELDING

TIG welding with the pulse feature is most often done for thin metals such as aluminum and can also be used with copper and varieties of steel. Pulsing can be set up with a foot pedal or as a setting on your TIG welder, but when should you use pulsing? There are some very specific applications for pulsing with a TIG welder and then there are times when it can just come in handy to get a job done better. Here's a look at some TIG welding with pulse applications:

Greater Control Over the Heat

Pulse for TIG is all about improving your control when you don't want to burn through your metal work piece. Using the pedal or setting up the pulse will moderate the heat as you weld and ensure you have enough heat present at the joint without laying a ton of filler metal into the joint or burning through the metal.

Too much metal in the weld joint could create a headache for your welding project, as you'll have to stop to grind it down and then clean up the metal before you can start welding again. The pulse setting gives you far more control over the welding process without compromising the strength and integrity of your weld.

When You Need a Neat Weld

Pulsing your weld is an easy way to create a smooth, clean weld for a TIG welding application.

Getting yourself in a steady pulsing rhythm is an ideal way to keep moving the puddle forward or walking the cup along a weld joint.

TIG welding is most often used when there is little margin for error and the metal is especially thin.

By pulsing along the weld joint you can moderate the amount of filler metal you add so that it's evenly distributed and you create a great looking weld.

Minimal Movement

If you're in a tight spot and you don't have a lot of room to maneuver, pulsing your TIG welder is one way to glide along the weld joint, adding filler metal as you go, without worrying about introducing too much heat and filler. The main thing for this application will be a steady hand on the torch and an even pace for the filler metal. If this is a particularly tight spot, you can pick up shorter torches that have a very small head and can fit in a variety of spaces. With TIG welding you can reach a tight spot much better than with a stick welder and you can control the input of filler metal better than with MIG, making it a great option when welding is particularly challenging.

Moving Faster with High Speed Pulse

Given some practice, many welders can effectively weld at the high speed of 150 pulses per second, creating neat welds in far less time. While you wouldn't want to try a faster pulsing speed if you're not used to it, many welders prefer to move either really slow or really fast in order to create a steady rhythm. Pulsing at around 20 per second has led some welders to make uneven, spotty welds.

This would be especially useful in a fabrication shop where you're seeing a lot of the same metal work pieces over and over and over again. If you have a handle on how fast you need to move on each piece, then there's a good chance you can bump up the pulsing rate to improve your welding speed.

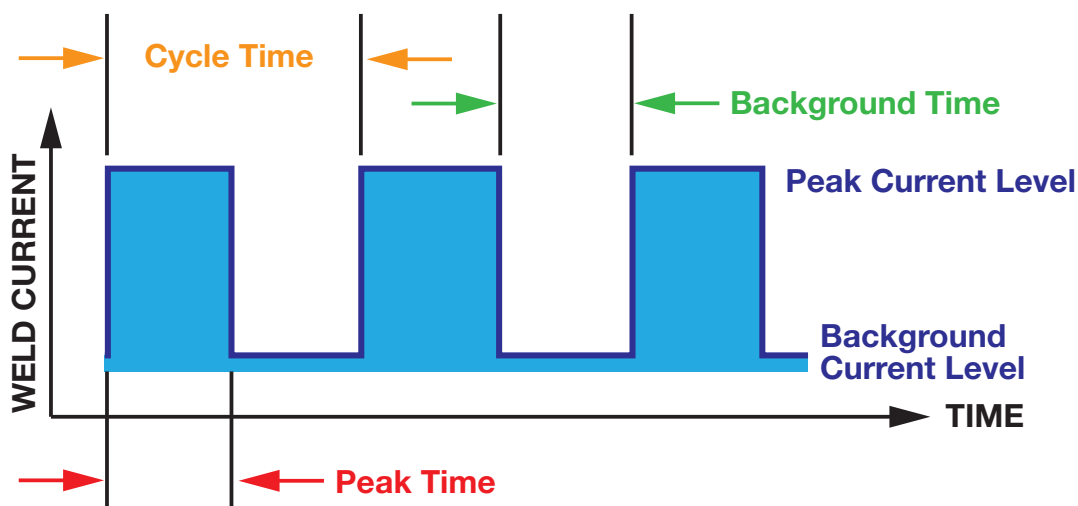

STICK AC / DC SETUP

Note: The below image shows setup for DCEP / Negative Polarity
(Most Common application)

6. Select Stick AC or DC mode

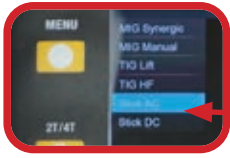

2. Connect Electrode holder to the **+** terminal

2. Connect earth Clamp to the **-** terminal



1 Plug the machine 10Amp input power lead into the wall socket, ensuring that the power switch on the machine is in the **OFF** position.

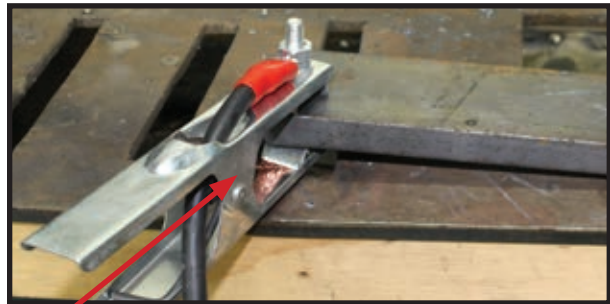

3 Connect earth clamp firmly to work-piece ensuring that the clamp makes good contact with bare metal.



2 Assemble Arc and Earth leads into the welding terminals depending on requirements of electrodes. Refer to your electrode packet for polarity and current requirements.

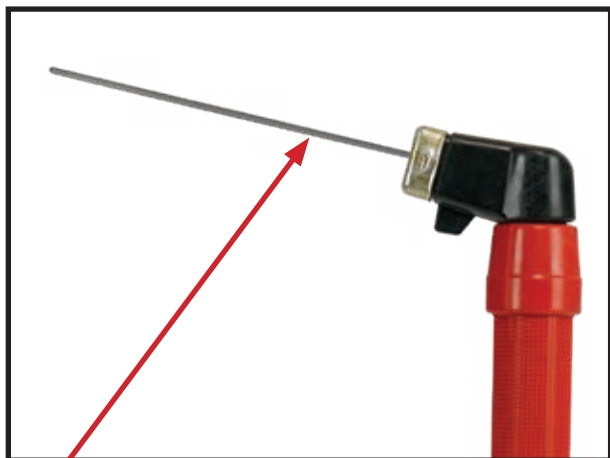

4 Take electrode holder and insert bare metal rod end of electrode and twist red handle to clamp electrode.

DCEP: Electrode connected to Positive (+) output socket.

DCEN: Electrode connected to Negative (-) output socket.

Note: Pictures may vary from your machine model

STICK AC / DC SETUP - CONTINUED



5 Ensure the electrode / electrode holder is not near the work-piece or can earth out, turn the machine on using the mains power switch. The front displays will light up and the cooling fan will start.



6 Press Menu button and adjust knob to select Stick AC or DC then press knob to confirm.

MMA (DC): Choosing the connection of DCEN or DCEP according to the different electrodes. Please refer to the electrode manual.

MMA (AC): No requirements for polarity connection.





7 Rotate left knob to adjust welding current.



Note: Pictures may vary from your machine model



8 Rotate right knob to adjust the welding voltage.

Press 1 time on the right knob for  **Hot Start**. This control provides extra power when the weld starts to counteract the high resistance of the electrode and workpiece as the arc is started.

Press 2 times on the right knob for  **Arc Force**. This control boosts the welding power if its senses the welding voltage is getting too low. The higher the arc force adjustment, the higher the minimum voltage that the power source will allow. This effect will also cause the welding current to increase.

Function	Setting
 Hot Start	0 ~ 10
 Arc Force	0 ~ 10

Average Metal Thickness	Electrode Size
1.0 - 2.0mm	2.0mm
2.0 - 5.0mm	2.6mm
5.0 - 8mm	3.2mm
8.0mm +	4.0mm

Amperage Selection Guide	
Rod Size/ Gauge	Welding Current
1.6mm	40-50 Amps
2.0mm	50-75 Amps
2.5mm	75-105 Amps
3.2mm	105-140 Amps
4.0mm	140-160 Amps

9 Please see table on page 39 as a guide to Welding Parameters.

Note: It is advisable to run a few test welds using scrap or offcut materials, in order to tune the machine to the correct settings prior to welding the job.

MANUAL METAL ARC PROCESS (MMA WELDING)

When an arc is struck between the metal rod (electrode) and the workpiece, both the rod and workpiece surface melt to form a weld pool. Simultaneous melting of the flux coating on the rod will form gas and slag which protects the weld pool from the surrounding atmosphere. The slag will solidify and cool and must be chipped off the weld bead once the weld run is complete (or before the next weld pass is deposited). The process allows only short lengths of weld to be produced before a new electrode needs to be inserted in the holder. Weld penetration is low and the quality of the weld deposit is highly dependent on the skill of the welder.

TYPES OF ELECTRODES

Arc stability, depth of penetration, metal deposition rate and positional capability are greatly influenced by the chemical composition of the flux coating on the electrode. There are many types of Electrodes, and these are generally matched to the base metal. For example if welding Mild Steel then select a Mild Steel (General Purpose Electrode). Electrodes are identified by a universal numbering system (AWS Type code).

Base Metal	Electrode Type	Type
Mild Steel	Mild Steel General Purpose	6013
Stainless Steel	Stainless Steel 316L	316L
Dissimilar Metals	Dissimilar 680	312
Cast Iron	Nickel Arc 98	Ni99
High Strength Steel	Low Hydrogen	TC16

Electrodes are often packed in sealed packaging to keep moisture out. However, if a pack has been opened or damaged, it is essential that the electrodes are redried according to the manufacturer's instructions.

ARC FORCE

Also called Dig and Arc Control. Gives a power source variable additional amperage during low voltage (short arc length) conditions while welding. Helps avoid "sticking" stick electrodes when a short arc length is used.

POWER SOURCE

Electrodes can be operated with AC and DC power supplies. Not all DC electrodes can be operated on AC power sources; however AC electrodes may be used on either AC or DC

ELECTRODE SIZE SELECTION

Electrode size selection will be determined by the thickness of the section being welded. A thicker section will need a larger diameter electrode. The table below shows the maximum size of electrodes for average thicknesses of section (based on General Purpose 6013 Electrode).

Average Metal Thickness	Electrode Size
1.0 - 2.0mm	2.0mm
2.0 - 5.0mm	2.6mm
5.0 - 8mm	3.2mm
8.0mm +	4.0mm

WELDING CURRENT

Welding current level is determined by the size of electrode - the normal operating range and current are recommended by manufacturers. Typical operating ranges for a selection of electrode sizes are illustrated in the table. As a rule of thumb when selecting a suitable current level, an electrode will require about 40 Amps per millimetre (diameter). Therefore, the preferred current level for a 4mm diameter electrode would be 160 Amps, but the acceptable operating range is 140 to 180 Amps. It is important to match the machine to the job

Amperage Selection Guide	
Rod Size/ Gauge	Welding Current
1.6mm	40-50 Amps
2.0mm	50-75 Amps
2.5mm	75-105 Amps
3.2mm	105-140 Amps
4.0mm	140-160 Amps

SET UP OF WIRE SPOOL & WIRE FEED UNIT

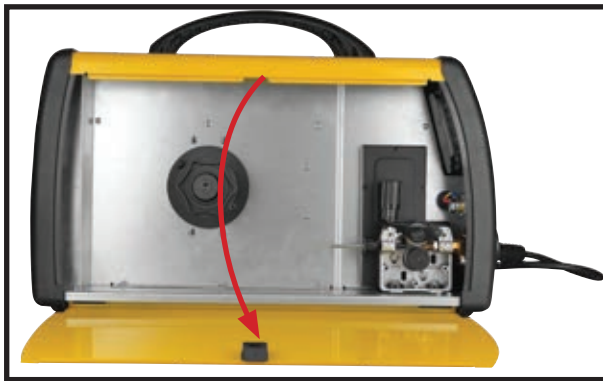

1 Open the side door of the machine.



2 Remove the Spool Hub Nut and place spool of wire on Spool Hub.
Note: Wire to roll from under spool into the wire guide inlet tube



3 Replace Spool Hub Nut and adjust firmly - without too much pressure.

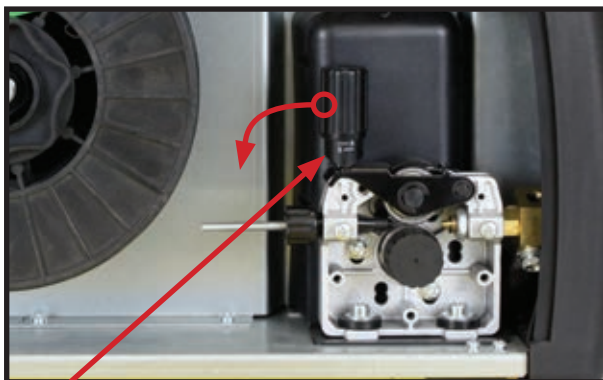

4 Release the Wire Feed Tensioning Knob by pulling it to the left.

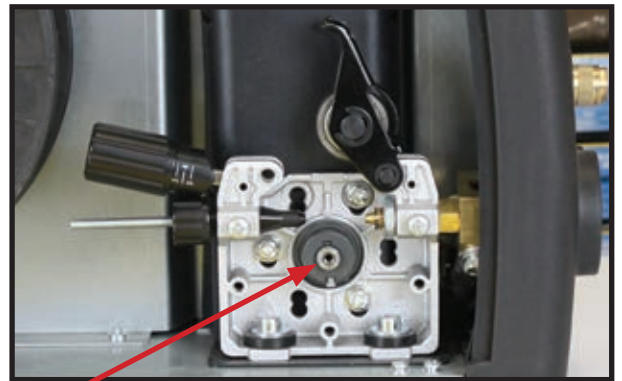

5 Remove the Drive Roller Cover. Check the Drive roller is matched to the wire size for the job. **Note:** Correct wire side on roller to face into machine when fitting. Then replace the Drive Roller Cover.

See Page 41 for drive roller size and type.

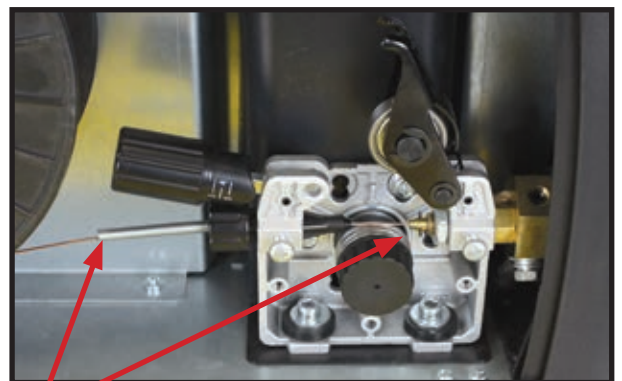

6 Take the end of the wire and feed into the Guide tube until it passes to the Inlet Tube, & out of the Euro connection Approx 3-5cm

Ensure you hold the spool and check tension to stop wire spool unraveling

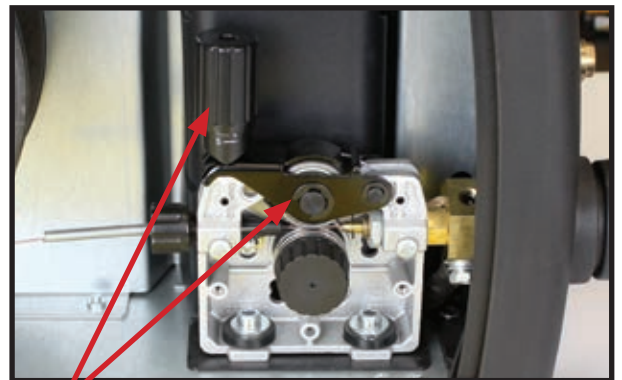

7 Put down Wire Tensioning Arm so it locks into position, and turn the Wire Feed Tensioning Knob to gently tighten.

Note: Pictures may vary from your machine model

MIG TORCH SET

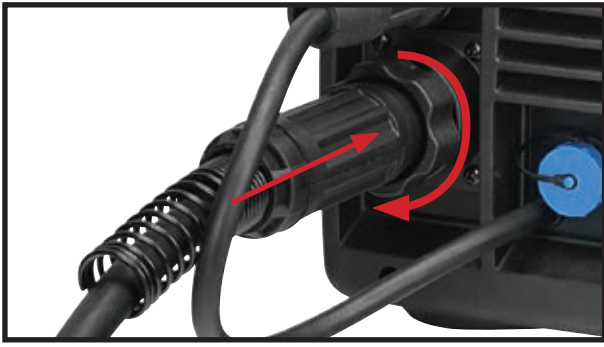

- 1** Attach the Euro Connect MIG torch to the machine feeding the wire into the liner. Tighten MIG Torch connector to machine.

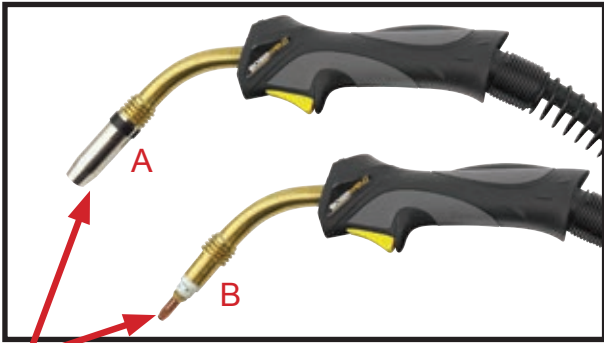

- 3** Remove nozzle (A) and tip (B) from torch.



- 4** Plug machine into 240V and switch to the ON position on the back of machine.

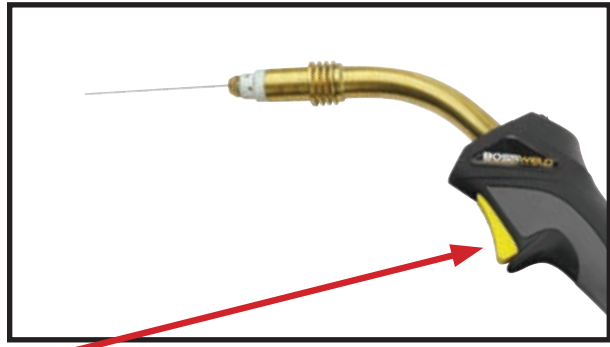

- 5** Press the trigger. This will feed the wire through the torch. Release button when wire appears at the end of the torch.

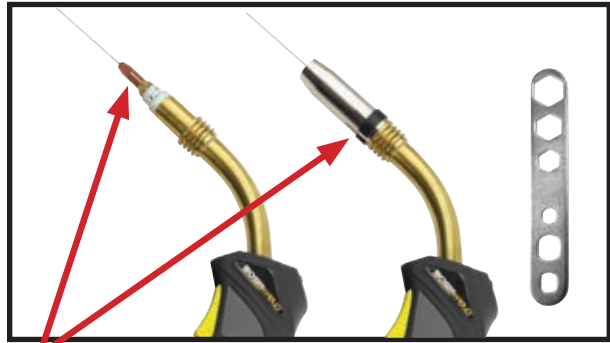

- 6** Re install tip over the wire and tighten using the tool supplied, Do NOT over tighten, or you may damage the tip holder and re-attach nozzle to torch.



- 7** Trim wire to the end of the nozzle.

MACHINE DRIVE ROLLER SIZE GUIDE (NOTE: MACHINE WILL RUN UP TO 1.2MM WIRE)

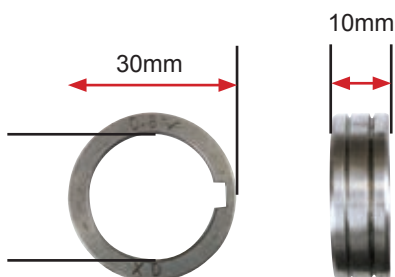

PART No:

Knurled Drive Roller For Gasless Wire

RK302210.08.10	Drive Roller 0.8/1.0mm Knurled 30 x 22 x 10mm
RK302210.09.12	Drive Roller 0.9/1.2mm Knurled 30 x 22 x 10mm
RK302210.10.12	Drive Roller 1.0/1.2mm Knurled 30 x 22 x 10mm

U Grooved Drive Roller For Aluminium Wire

RU302210.06.08	Drive Roller 0.6/0.8mm U Groove 30 x 22 x 10mm
RU302210.08.09	Drive Roller 0.8/0.9mm U Groove 30 x 22 x 10mm
RU302210.08.10	Drive Roller 0.8/1.0mm U Groove 30 x 22 x 10mm
RU302210.09.12	Drive Roller 0.9/1.2mm U Groove 30 x 22 x 10mm

V Grooved Drive Roller For Solid Wire

RV302210.06.08	Drive Roller 0.6/0.8mm V Groove 30 x 22 x 10mm
RV302210.08.10	Drive Roller 0.8/1.0mm V Groove 30 x 22 x 10mm
RV302210.09.12	Drive Roller 0.9/1.2mm V Groove 30 x 22 x 10mm
RV302210.10.12	Drive Roller 1.0/1.2mm V Groove 30 x 22 x 10mm

Note: Pictures may vary from your machine model

MIG TORCH LINER INSTALLATION / REPLACEMENT

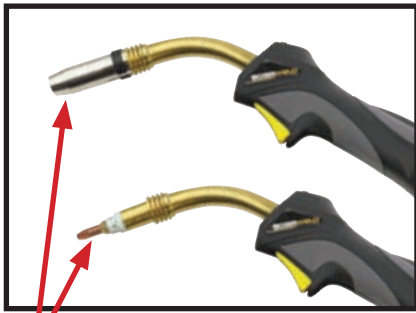

1 Lay the MIG torch out straight and flat on the ground and remove the front end parts

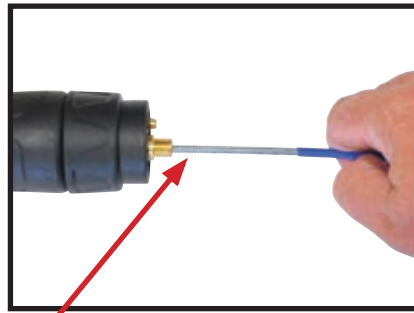

4 Carefully feed the new liner into the torch lead all the way out the end of the torch

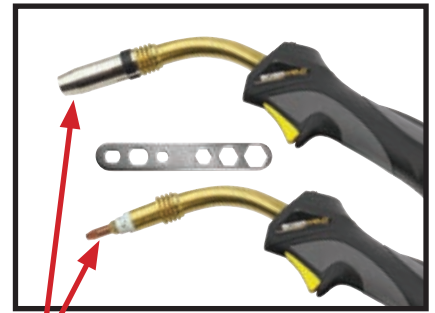

7 Re install tip and tighten using the tool provided and re attach nozzle to torch. Do NOT over tighten, or you may damage the tip holder

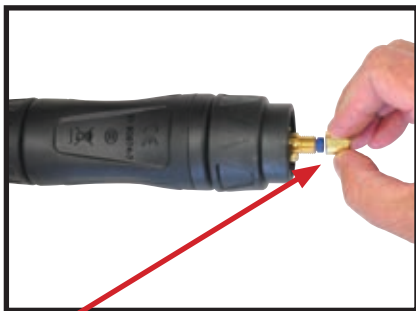

2 Remove the liner retaining nut from the euro torch end

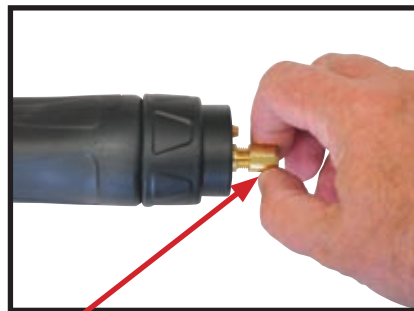

5 Fit the retaining nut and slightly tighten the nut about half way

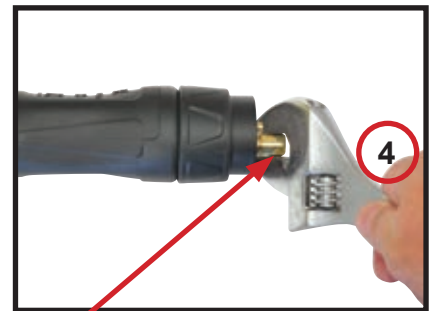

8 Tighten the retaining nut up all the way

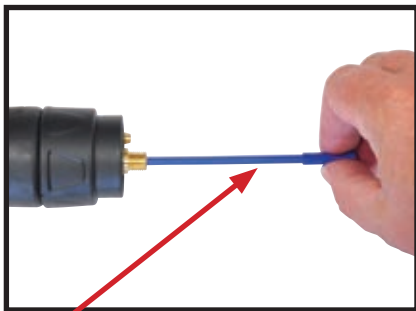

3 Carefully remove the liner completely from the torch

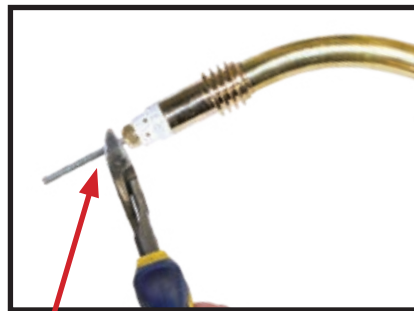

6 Snip the new liner 3mm past the end of the torch neck

Steel Liners



Teflon Liners for Aluminium



PART NO.	DESCRIPTION	ORIGINAL REF
92.04.B3	Blue steel liner 0.6 - 0.8mm 3mt	124.0011
92.04.B4	Blue steel liner 0.6 - 0.8mm 4mt	124.0012
92.04.B5	Blue steel liner 0.6 - 0.8mm 5mt	124.0015
92.04.R3	Red steel liner 0.9 - 1.2mm 3mt	124.0026
92.04.R4	Red steel liner 0.9 - 1.2mm 4mt	124.0031
92.04.R5	Red steel liner 0.9 - 1.2mm 5mt	124.0035
92.04.BT3	Blue teflon liner 0.6 - 0.9mm 3mt	126.0005
92.04.BT4	Blue teflon liner 0.6 - 0.9mm 4mt	126.0008
92.04.RT3	Red teflon liner 0.9 - 1.2mm 3mt	124.0011
92.04.RT4	Red teflon liner 0.9 - 1.2mm 4mt	124.0012
92.04.RT5	Red teflon liner 0.9 - 1.2mm 5mt	124.0015

Note: Pictures may vary from your machine model

Proper MIG Torch inspection

Prior to welding, ensure all connections are tight and that consumables and equipment are in good condition and free from damage. Start with the front of the gun and work your way back to the feeder. A tight neck connection is essential to carry the electrical current from the welding cable to the front-end consumables. Also, be sure to visually inspect the handle and trigger to check there are no missing screws or damage. The cable should be free of cuts, kinks and damage along the outer cover. Cuts in the cable can expose the internal copper wiring and create a potential safety hazard to the welding operator. In addition, these issues can lead to electrical resistance that causes heat buildup — and ultimately cable failure.

Consumables

MIG gun front-end consumables are exposed to heat and spatter and therefore often require frequent replacement. However, performing some simple maintenance can help extend consumable life and improve gun performance and weld quality. The gas diffuser provides gas flow to the weld pool and also connects to the neck and carries the electrical current to the contact tip. Make sure all connections are tight, and check the diffuser's O-rings for cracks, cuts or damage. The nozzle's main role is to focus the shielding gas around the weld pool. Watch for spatter buildup in the nozzle, which can obstruct gas flow and lead to problems due to inadequate shielding coverage. Use MIG pliers to clean spatter from the nozzle. The contact tip is the last point of contact between the welding equipment and the welding wire. Keyholing of the contact tip is a concern to watch for with this consumable. This occurs when the wire passing through the tip wears an oblong-shaped slot into the diameter of the tip. Keyholing can put the wire out of center and cause problems such as an erratic arc. If you are experiencing wire feeding issues, try changing the contact tip or switching to a larger-size contact tip. Tips that look worn should be replaced.

Spatter removal from inside and outside the nozzle using MIG pliers

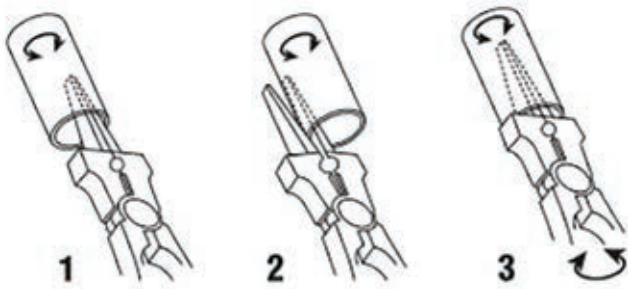

Build up of spatter can cause damage to nozzle and tip

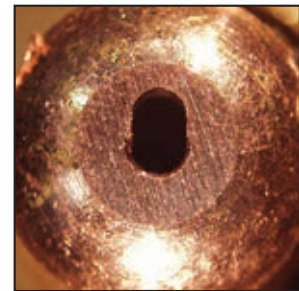

Keyholing of the contact tip

Final thoughts

Taking the time for preventative maintenance can pay off in less downtime in the long run. Along with that, always remember to properly store your MIG gun consumables to help you achieve the best results and extend the life of your equipment. When not in use, the MIG gun should be stored in a coiled position, either hanging or lying flat, such as on a shelf. Do not leave MIG gun on the floor of the shop, where there is a chance the cable could be run over, kinked or damaged.

WELDING PRODUCTS TO HELP PROLONG, MAINTAIN AND PRODUCE BETTER WELDS

Bossweld Aerosol Anti Spatter Spray

This silicon free spatter release coating is a colourless film which stops weld spatter from sticking to welding equipment, work pieces & fixtures. Easily removed before painting or finishing.

Bossweld Tip Dip Gel

Non toxic water based dipping gel for the prevention of weld spatter adherence to MIG torch parts. This silicon free compound is used to prolong the life of nozzles & tips.

Bossweld 8 Ways MIG Welding Pliers

Handy 8 function welders pliers. Functions include, nozzle removal, tip removal, cleaning inside of nozzle and wire cutting.



LIST OF ERROR CODES

Error Type	Code	Description
Thermal relay	E01	Over-heating (1st thermal relay)
	E02	Over-heating (2nd thermal relay)
	E03	Over-heating (3rd thermal relay)
	E04	Over-heating (4th thermal relay)
	E09	Over-heating (Program default)
Welding machine	E10	Phase loss
	E11	N/A
	E12	No gas
	E13	Under voltage
	E14	Over voltage
	E15	Over current
	E16	Wire feeder over load
Switch	E20	Button fault on operating panel when switch on the machine
	E21	Other faults on operating panel when switch on the machine
	E22	Torch fault when switch on the machine
	E23	Torch fault during normal working process
Accessory	E30	Cutting torch disconnection
	E31	N/A
Communication	E40	Connection problem between wire feeder and power source
	E41	Communication error



JOB PROGRAM DISPLAY INTRODUCTION



- 1. JOB button:** Press it for 3s to enter JOB programs and press it for 1s to save parameters. (Can't save when all slots are in used)
- 2. Parameters display:** Selected parameter settings.
- 3. JOB number display:** 10 slots to save your parameter settings
- 4. L parameter knob:** Rotate it to turn the page and press it to delete the parameters.
- 5. R parameter knob:** Rotate it to select JOB program number and press it to load the selected JOB program number.

BZ 24 BOSSWELD BINZEL STYLE MIG TORCH COMPLETE

PART NO.	DESCRIPTION
92.ER.24.3	BZ Style 24 MIG Torch 3m
92.ER.24.4	BZ Style 24 MIG Torch 4m
92.ER.24.5	BZ Style 24 MIG Torch 5m



BOSSWELD BINZEL STYLE 24 MIG TORCH SPARE PARTS



PART NO.	DESCRIPTION	ORIGINAL REF
92.02.24.CO	Adjustable conical nozzle ϕ 12.5 STD	145.0075
92.02.24.CL	Adjustable cylindrical ϕ 17mm	145.0022
92.02.24.10	Adjustable tapered nozzle ϕ 10mm	145.0123



PART NO.	DESCRIPTION	ORIGINAL REF
92.05.24.M6	Tip Holder M6	142.0003



PART NO.	DESCRIPTION	ORIGINAL REF
92.05.24	Gas Diffuser - Ceramic	012.0017
92.05.24R	Gas Diffuser - Red Rubber	N/A



PART NO.	DESCRIPTION	ORIGINAL REF
92.06.24	Swan Neck	012.0001



PART NO.	DESCRIPTION	ORIGINAL REF
92.09.HANDLE	Ergonomic handle with screws	N/A
92.09.BWT	Trigger	N/A



PART NO.	DESCRIPTION	ORIGINAL REF
92.01.15.06	Contact tip 0.6mm x M6 x 6mm dia x 25mm long	140.0008
92.01.15.08	Contact tip 0.8mm x M6 x 6mm dia x 25mm long	140.0059
92.01.15.09	Contact tip 0.9mm x M6 x 6mm dia x 25mm long	140.0177
92.01.15.10	Contact tip 1.0mm x M6 x 6mm dia x 25mm long	140.0253
92.01.25.06	Contact tip 0.6mm x M6 x 8mm dia x 25mm long	140.0005
92.01.25.08	Contact tip 0.8mm x M6 x 8mm dia x 25mm long	140.0051
92.01.25.09	Contact tip 0.9mm x M6 x 8mm dia x 25mm long	140.0169
92.01.25.10	Contact tip 1.0mm x M6 x 8mm dia x 25mm long	140.0242
92.01.25.12	Contact tip 1.2mm x M6 x 8mm dia x 25mm long	140.0379
92.01.25.14	Contact tip 1.4mm x M6 x 8mm dia x 25mm long	140.0516
92.01.25.16	Contact tip 1.6mm x M6 x 8mm dia x 25mm long	140.0555
92.01.M6A09	Contact tip 0.9mm x M6 Al x 8mm dia x 28mm long	141.0004
92.01.M6A10	Contact tip 1.0mm x M6 Al x 8mm dia x 28mm long	141.0006
92.01.M6A12	Contact tip 1.2mm x M6 Al x 8mm dia x 28mm long	141.0072

Steel Liners

Teflon Liners for Aluminium

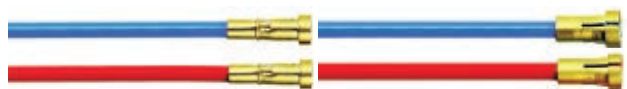

PART NO.	DESCRIPTION	ORIGINAL REF
92.04.B3	Blue steel liner 0.6 - 0.8mm 3mt	124.0011
92.04.B4	Blue steel liner 0.6 - 0.8mm 4mt	124.0012
92.04.B5	Blue steel liner 0.6 - 0.8mm 5mt	124.0015
92.04.R3	Red steel liner 0.9 - 1.2mm 3mt	124.0026
92.04.R4	Red steel liner 0.9 - 1.2mm 4mt	124.0031
92.04.R5	Red steel liner 0.9 - 1.2mm 5mt	124.0035
92.04.BT3	Blue teflon liner 0.6 - 0.9mm 3mt	126.0005
92.04.BT4	Blue teflon liner 0.6 - 0.9mm 4mt	126.0008
92.04.RT3	Red teflon liner 0.9 - 1.2mm 3mt	124.0011
92.04.RT4	Red teflon liner 0.9 - 1.2mm 4mt	124.0012
92.04.RT5	Red teflon liner 0.9 - 1.2mm 5mt	124.0015

BOSSWELD 17 SERIES 150AMP & 26 SERIES 180AMP TIG TORCH COMPLETE & SPARES



PART NO.	DESCRIPTION
95.17F.4.1.SW9A	Bossweld 17 Series TIG Torch 4mt 9 pin Plug
95.17F.8.1.SW9A	Bossweld 17 Series TIG Torch 8mt 9 pin Plug
95.26F.4.1.SW9A	Bossweld 26 Series TIG Torch 4mt 9 pin Plug
95.26F.8.1.SW9A	Bossweld 26 Series TIG Torch 8mt 9 pin Plug



PART NO.	DESCRIPTION
9957Y04	Back Cap Short
9557Y05	Back Cap Medium
955Y02	Back Cap Long



PART NO.	DESCRIPTION
9510N21	Collet 0.5mm
9510N22	Collet 1.0mm
9510N23	Collet 1.6mm
9510N24	Collet 2.4mm
9510N25	Collet 3.2mm
9510N20	Collet 4.0mm



PART NO.	DESCRIPTION
9510N29	Collet Body 0.5mm
9510N30	Collet Body 1.0mm
9510N31	Collet Body 1.6mm
9510N32	Collet Body 2.4mm
9510N28	Collet Body 3.2mm
95406488	Collet Body 4.0mm



PART NO.	DESCRIPTION
9510N50	Alumin Cup Size 4
9510N49	Alumin Cup Size 5
9510N48	Alumin Cup Size 6
9510N47	Alumin Cup Size 7
9510N46	Alumin Cup Size 8
9510N45	Alumin Cup Size 10
9510N44	Alumin Cup Size 12



PART NO.	DESCRIPTION
9518CG	Torch Body Front Insulator
9554N01	Torch Body Front Insulator Lens Cup



PART NO.	DESCRIPTION
95WP26	Torch Head
954WP26V	Torch Head with Valve
95WP26F	Flex Torch Head
95WP26FV	Flex Torch Head with Valve



PART NO.	DESCRIPTION
9545V24	Gas Lens Collet 1.0mm
9545V25	Gas Lens Collet 1.6mm
9545V26	Gas Lens Collet 2.4mm
9545V27	Gas Lens Collet 3.2mm
9545V28	Gas Lens Collet 4.0mm



PART NO.	DESCRIPTION
9554N18	Gas Len Alumin Cup Size 4 - 6.0mm
9554N17	Gas Len Alumin Cup Size 5 - 8.0mm
9554N16	Gas Len Alumin Cup Size 6 - 9.5mm
9554N15	Gas Len Alumin Cup Size 7 - 11.0mm
9554N14	Gas Len Alumin Cup Size 8 - 12.7mm
9554N19	Gas Len Alumin Cup Size 11 - 17.5mm

BOSSWELD SPOOL GUN 180/250AMP - 9PIN

This spool gun is the perfect solution for welding soft alloys, especially aluminium where feeding the aluminium MIG wire is always a challenge due to birds nesting, tangles and feedability problems. A spool gun overcomes these issues by providing a reliable solution that delivers the wire at the gun point with a short feed length compared to a standard mig gun length of at least 3 metres.

FEATURES

- Suits the X series range of machines.
- Primarily used for MIG (GMAW) welding of aluminium and aluminium alloys.
- Can be also used for MIG welding of mild steel and stainless steel.



SPX15 SPOOL GUN

NO.	PART NO.	DESCRIPTION
	97.SPX15.4.9	Bossweld 4mt spool gun SPX15 9 pin Plug
	97.SPX15.8.9	Bossweld 8mt spool gun SPX15 9 pin Plug
1	92.05.15	Tip holder with spring l/hand
2	92.01.M6A09	Contact Tip 0.9mm x M6 Al x 8mm dia x 28mm long
	92.01.M6A10	Contact Tip 1.0mm x M6 Al x 8mm dia x 28mm long
3	92.01.15.08	Contact Tip 0.8mm x M6 x 6mm dia x 25mm long
	92.01.15.09	Contact Tip 0.9mm x M6 x 6mm dia x 25mm long
	92.01.15.10	Contact Tip 1.0mm x M6 x 6mm dia x 25mm long
4	92.01.25.06	Contact Tip heavy duty 0.6mm x M6 x 8mm dia x 25mm long
	92.01.25.08	Contact Tip heavy duty 0.8mm x M6 x 8mm dia x 25mm long
	92.01.25.09	Contact Tip heavy duty 0.9mm x M6 x 8mm dia x 25mm long
	92.01.25.10	Contact Tip heavy duty 1.0mm x M6 x 8mm dia x 25mm long
5	92.02.15.10	Adjustable tapered nozzle ϕ 10mm
6	92.02.15.CO	Adjustable conical nozzle ϕ 12 mm
7	92.02.15.CL	Adjustable cylindrical nozzle ϕ 19mm

Current	180 Amps
Duty Cycle @ 40°C	60% @ 180 Amps CO2 60% @ 150 Amps MIX
Cooling	Air
Wire Size	0.6mm > 1.0mm

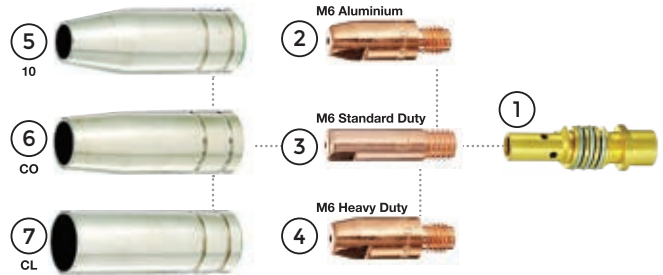

SPX24 SPOOL GUN

NO.	PART NO.	DESCRIPTION
	97.SPX24.4.9	Bossweld 4mt spool gun SPX24 9 pin Plug
	97.SPX24.8.9	Bossweld 8mt spool gun SPX24 9 pin Plug
1	92.05.24R	Gas Diffuser - Red Rubber
2	92.05.24	Gas Diffuser - Ceramic
3	92.05.24.M6	Tip Holder M6
4	92.01.M6A09	Contact Tip 0.9mm x M6 Al x 8mm dia x 28mm long
	92.01.M6A10	Contact Tip 1.0mm x M6 Al x 8mm dia x 28mm long
	92.01.M6A12	Contact Tip 1.2mm x M6 Al x 8mm dia x 28mm long
5	92.01.15.08	Contact Tip 0.8mm x M6 x 6mm dia x 25mm long
	92.01.15.09	Contact Tip 0.9mm x M6 x 6mm dia x 25mm long
	92.01.15.10	Contact Tip 1.0mm x M6 x 6mm dia x 25mm long
6	92.01.25.08	Contact Tip heavy duty 0.8mm x M6 x 8mm dia x 25mm long
	92.01.25.09	Contact Tip heavy duty 0.9mm x M6 x 8mm dia x 25mm long
	92.01.25.10	Contact Tip heavy duty 1.0mm x M6 x 8mm dia x 25mm long
	92.01.25.12	Contact Tip heavy duty 1.2mm x M6 x 8mm dia x 25mm long
7	92.02.24.10	Adjustable tapered nozzle ϕ 10mm
8	92.02.24.CO	Adjustable conical nozzle ϕ 12.5 mm
9	92.02.24.CL	Adjustable cylindrical nozzle ϕ 17mm



Current	250 Amps
Duty Cycle @ 40°C	60% @ 250 Amps CO2 60% @ 220 Amps MIX
Cooling	Air
Wire Size	0.6mm > 1.2mm

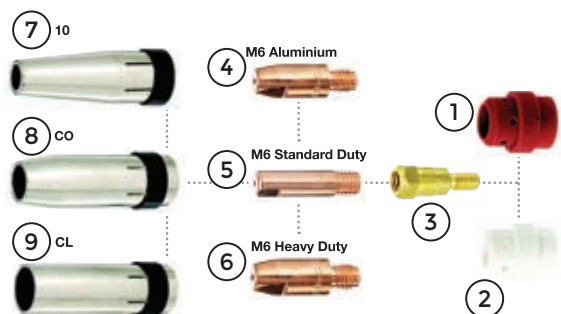

HELPFUL INFORMATION

Filler Metal	Notes
Solid Mild Steel wire	<ul style="list-style-type: none"> • Use Industry standard - copper coated ER70S-6 Steel MIG Wire. This requires a shielding gas (CO2 or argon/CO2 mix), excellent results on panel steel.
Gasless Flux cored Mild Steel Wire (Known as GS)	<ul style="list-style-type: none"> • Use Industry standard flux cored ER71T-GS Steel MIG Wire. This does not require a shielding gas. • Suitable for outside use where gas shield can be blown away or not available. • Suitable for seldom use or when bottle hire is not practical or too costly for small jobs and infrequent use. • Great on galvanised materials • Not suitable for panel steel • Leaves chalky residue. This is normal. • Produces smoke and splatters.
Drive Feed Roller Selection	It is important that correct drive roller is used to get the best results.
Solid mild steel Stainless steel wire	"V" groove Roller. Roller has a small V shaped groove to guide the wire.
Flux cored wire	"V Knurled" roller (assists in gripping as wire is soft)
Aluminium wire	"U" groove Roller (assist in gripping as wire is softest)
Polarity	Machine can be used in both DC + and DC - modes
Wire Type -Gas shield wire (solid or CO2 shielded flux)	"- " earth
Self-shielded Flux core Wire	"+ " earth
Aluminium	3m only for push torch, Teflon liner, "U" groove roller, alloy tips or one size larger, argon shielding wire

OPERATIONAL ENVIRONMENT

- Height above sea level $\leq 1000\text{m}$
- Operation temperature range $-10^{\circ}\text{C} \sim +40^{\circ}\text{C}$
- Air relative humidity is below 90% (20°C)
- Preferably sit the machine above floor level, ensure the maximum angle does not exceed 15 degrees.
- Protect the machine against heavy rain and against direct sunshine.
- The content of dust, acid, corrosive gas in the surrounding air or substance must not exceed normal standards.
- Take care that there is sufficient ventilation during welding. There must be at least 30cm free distance between the machine and wall.

MIG WIRE FEED TROUBLE SHOOTING

The following chart addresses some of the common WIRE FEED problems during MIG welding.

Issue	Possible Reason	Suggested Remedy
No wire feed	<ul style="list-style-type: none"> • Wrong mode selected 	<ul style="list-style-type: none"> • Check that the TIG/MMA/MIG selector switch set to MIG position
Inconsistent / interrupted wire feed	<ul style="list-style-type: none"> • Adjusting wrong dial • Wrong polarity selected • Incorrect wire speed setting • Voltage setting incorrect • MIG torch lead too long • MIG torch lead kinked or too sharp angle being held • Contact tip worn, wrong size, wrong type • Liner worn or clogged (the most common causes of bad feeding) • Wrong size liner • Blocked or worn inlet guide tube • Wire misaligned in drive roller groove • Incorrect drive roller size • Wrong type of drive roller selected • Worn drive rollers • Drive roller pressure too high • Too much tension on wire spool hub • Wire crossed over on the spool or tangled • Contaminated MIG wire 	<ul style="list-style-type: none"> • Be sure to adjust the wire feed and voltage dials for MIG welding. The amperage dial is for MMA and TIG welding mode. • Select the correct polarity for the wire being used - see machine set up. • Adjust the wire feed speed • Adjust the voltage setting Small diameter wires and soft wires like aluminium don't feed well through long torch leads - replace the torch with a lesser length torch. • Remove the kink, reduce the angle or bend • Replace the tip with correct size and type • Try to clear the liner by blowing out with compressed air as a temporary cure, it is recommended to replace the liner. • Install the correct size liner • Clear or replace the inlet guide tube • Locate the wire into the groove of the drive roller • Fit the correct size drive roller e.g. 0.8mm wire requires 0.8mm drive roller. • Fit the correct type roller (e.g. knurled rollers needed for flux cored wires). • Replace the drive rollers Can flatten the wire electrode causing it to lodge in the contact tip - reduce the drive roller pressure. • Reduce the spool hub brake tension • Remove the spool untangle the wire or replace the wire. • Use clean dry rust free wire. Do not lubricate the wire with oil, grease etc.

TROUBLE SHOOTING

Issue	Possible Reason	Suggested Remedy
Power indicator is not lit, fan does not work and no output current	<ul style="list-style-type: none"> • Welder is not plugged into power supply • Circuit breaker may have operated • Main power switch may not be in the ON position 	<ul style="list-style-type: none"> • Check that the welder is plugged into the 240V mains outlet and is switched on. • Check that the mains fuse or breaker has not operated. • Check that the main switch on the rear of the unit is in the on position.
Power indicator is lit, fan works, no output current	<ul style="list-style-type: none"> • Output connectors may be disconnected or damaged • Welding cables or earth clamp not connected properly 	<ul style="list-style-type: none"> • Check output connectors are connected properly and are not damaged • Check connections and that workpiece is free of paint and rust at connection point
Over temperature indicator is on, no output current	<ul style="list-style-type: none"> • Duty cycle of the unit has been exceeded. . 	<ul style="list-style-type: none"> • Allow the unit to cool for 20 minutes
Output current is not stable.	<ul style="list-style-type: none"> • Earth clamp connection loose • Mains Voltage is not constant • Loose welding cables • Leads reversed 	<ul style="list-style-type: none"> • Check earth clamp is connected to work piece properly. • Change the Main Supply to an alternative • Check the welding connectors are tight in the sockets. • Check Leads are not reversed and correct +/-
Hot Welding Clamp	Welding clamp rated current is too small,	Replace with larger size welding clamp.
Excessive Spatter	<ul style="list-style-type: none"> • Wire feed speed set too high • Voltage too high • Wrong polarity set • Stick out too long • Contaminated base metal Contaminated MIG wire • Inadequate gas flow or too much gas flow • Worn contact tip 	<ul style="list-style-type: none"> • Select lower wire feed speed • Select a lower voltage setting • Select the correct polarity for the wire being used • Bring the torch closer to the work • Remove materials like paint, grease, oil, and dirt, including mill scale from base metal • Use clean dry rust free wire. Do not lubricate the wire with oil, grease etc • Check the gas is connected, check hoses, gas valve and torch are not restricted. Set the gas flow between 6-12 l/min flow rate. Check hoses and fittings for holes, leaks. Protect the welding zone from wind and drafts • Change contact tip.
Porosity - small cavities or holes resulting from gas pockets in weld metal	<ul style="list-style-type: none"> • Wrong gas • Inadequate gas flow or too much gas flow • Moisture on the base metal • Contaminated base metal • Contaminated MIG wire • Loose gas connection 	<ul style="list-style-type: none"> • Check that the correct gas is being used • Check the gas is connected; check hoses, gas valve and torch are not restricted. Set the gas flow between 10 - 15 l/min flow rate. Check hoses and fittings for holes, leaks etc. Protect the welding zone from wind and drafts • Remove all moisture from base metal before welding • Remove materials like paint, grease, oil, and dirt, including mill scale from base metal • Use clean dry rust free wire. Do not lubricate the wire with oil, grease etc. • Check and tighten connection.

TROUBLE SHOOTING - CONTINUED

Issue	Possible Reason	Suggested Remedy
Porosity - small cavities or holes resulting from gas pockets in weld metal	<ul style="list-style-type: none"> • Gas nozzle clogged with spatter, worn or out of shape • Missing or damaged gas diffuser • MIG torch euro connect O-Ring missing or damaged 	<ul style="list-style-type: none"> • Clean or replace the gas nozzle • Replace the gas diffuser • Check and replace the O-Ring
Wire stubbing during welding	<ul style="list-style-type: none"> • Holding the torch too far away • Welding voltage set too low • Wire speed set too high 	<ul style="list-style-type: none"> • Bring the torch closer to the work and maintain stick out of 5-10mm • Increase the voltage • Decrease the wire feed speed
Lack of Fusion – failure of weld metal to fuse completely with base metal or a proceeding weld bead	<ul style="list-style-type: none"> • Contaminated base metal • Not enough heat input • Improper welding technique • Too much heat 	<ul style="list-style-type: none"> • Remove materials like paint, grease, oil, and dirt, including mill scale from base metal • Select a higher voltage range and /or adjust the wire speed to suit <p>Keep the arc at the leading edge of the weld pool. Gun angle to work should be between 5 & 15° Direct the arc at the weld joint</p> <p>Adjust work angle or widen groove to access bottom during welding, Momentarily hold arc on side walls if using weaving technique</p> <ul style="list-style-type: none"> • Select a lower voltage range and /or adjust the wire speed to suit Increase travel speed
Excessive Penetration – weld metal melting through base meta	<p>Poor in incorrect joint preparation</p>	<ul style="list-style-type: none"> • Material too thick. Joint preparation and design needs to allow access to bottom of groove while maintaining proper welding wire extension and arc characteristics <p>Keep the arc at the leading edge of the weld pool and maintain the gun angle at 5 & 15° keeping the stick out between 5-10mm</p>
Lack of Penetration – shallow fusion between weld metal and base metal	<ul style="list-style-type: none"> • Not enough heat input • Contaminated base metal 	<ul style="list-style-type: none"> • Select a higher voltage range and /or adjust the wire speed to suit Reduce travel speed • Remove materials like paint, grease, oil, and dirt, including mill scale from base metal
Error Codes display on screen (E01 to E41)	<p>A range of trouble shooting in</p> <ul style="list-style-type: none"> • Thermal relay • Welding machine • Switch • Accessory • Communication 	<p>Check page 13 for the list of error code's descriptions</p>



OTHER PRODUCTS IN OUR RANGE

- ELECTRODES
- TIG RODS
- WELDING HELMETS
- WELDING MACHINES
- TORCH SPARE PARTS
- WELDING ACCESSORIES
- MIG WIRE
- GAS EQUIPMENT
- WELDING SAFETY
- MIG TORCHES
- TIG TORCHES
- WELDING CABLE

BOSSWELD *X* series
WELD LIKE A BOSS