

INNOVATIVE FIT-UP
TOOLS: CLAMPS,
MAGNETS, PLIERS
AND WELDING
TABLES.





We are dedicated to helping you work safely, efficiently, comfortably, and cost effectively.

We're on a mission to make "Better Tools at Better Prices." For over 35 years we have communicated with welders and craftsmen to develop innovative, quick-acting clamping tools that allow you to create a "proper" setup as the foundation for safe, and efficient work in welding, assembly, and repair applications. We've re-engineered traditional tools such as: Sliding Arm Clamps, Magnetic Welding Squares, Pliers, and Vises for improved performance in clamping and fixturing.

Strong Hand Tools Features and Benefits:

Our tools are multi-functional, and adaptable for all types of workholding in welding, assembly, and repair operations.

All Strong Hand Tools are "Quick Acting" for fast setup and affordably priced to fit any budget.

We remain dedicated to designing the most innovative, time-saving, money-saving workholding tools to improve your efficiency, productivity, and profitability.

Find your local Strong Hand Tools Distributor at:

www.StrongHandTools.com.

BE SURE TO LOOK FOR
GENUINE, PATENTED
STRONG HAND TOOLS®



Modular Welding Tables
www.BuildProTables.com



Heavy Duty German Made Welding Tables
www.siegmundtables.com



Operating Accessories & Tooling Components
www.valtrainc.com



Toggle Clamps & Latches
www.goodhandinc.com

* Call to request the full line catalogs 

US HEADQUARTERS

8750 Pioneer Blvd., Santa Fe Springs, CA 90670

Tel: 562-949-8625

Fax: 562-949-4875

sales@stronghandtools.com

EUROPE

Pražská 410/11
67401 Třebíč, Czech Republic

Tel: +420 607 088 466

Fax: +420 568 853 213

sales@stronghand.eu

CHINA

No. 605 Huabo Rd., Huating
Town, Jiading District,
Shanghai, China 201816

Tel: +86-21-59103639

Fax: +86-21-59102951

asiasales@stronghandtools.com



Table of Contents



WELDING CLAMPS

- 4** 4-in-1™ Clamps
- 6** Utility Clamps
- 8** Ratchet Action Clamps
- 8** MagSpring™ Clamps
- 9** Pipe Alignment Clamps
- 9** Pipe Fit-up Clamps



MAGNETIC SQUARES

- 10** Adjust-O™ Magnet Squares
- 11** Adjust-O™ Dual Switch Magnets
- 11** Adjust-O™ Angle Magnets
- 12** A-Frame Heavy Duty Magnet
- 12** Multi-Angle Magnets
- 13** Mini Magnets
- 13** XYZ 3-Axis Magnets



MAGNETIC POSITIONERS

- 14** MagTabs™
- 15** MagRest™ & MagHold™ V-Pad Kits
- 16** MagHold™ Extendable Arm
- 16** Snake Magnets
- 17** Sheet Metal Magnet
- 17** Corner Magnets
- 18** Inside Outside Angle Magnets



OTHER MAGNETIC TOOLS

- 19** Grinder Rests
- 19** Mig/Tig Gun Holders
- 33** Mag-Level



PLIERS

- 20** Big Mouth Pliers
- 21** Strong Grip® Pliers
- 24** Pliers Holder
- 25** Pipe Pliers
- 26** Locking C-Clamps
- 27** Multi-Purpose Pliers
- 27** Adjustable Reach & Long Reach
- 28** JointMaster™
- 29** 3-Axis Clamping Kit
- 29** Expand-O™ Pliers

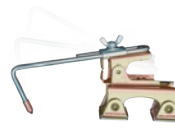

"THIRD-HAND" CLAMPS

- 30** Third Hand Modular Clamps
- 31** Grasshoppers



2 & 3 AXIS FIXTURE VISES

- 32** 2-Axis Vises
- 32** 3-Axis Vises
- 33** 90° Tru AngL Vises
- 33** Portable MagVises



GROUNDING TOOLS

- 34** Powerbase™ Grounding Magnets
- 34** Grounding Clamps



HOLD DOWN CLAMPS

- 35** Table Mount C-Clamps
- 35** Drill Press clamp
- 36** Half Clamps
- 36** Hold Down Clamps
- 37** Side Clamps
- 38** Platen Clamps



NOMAD™ WELDING TABLES

39



ACCESSORIES & REPLACEMENT PARTS

40



OTHER PRODUCT LINES

42

* All products, product specifications and data are subject to change without notice to improve reliability, function, design or otherwise.



4-IN-1™ Utility Clamping System

The most versatile Sliding Arm Clamps in the market.



Ergonomic Comfort Handle with purchase of G / M Rail clamps.

UM Models:
Plastic handle ONLY
UG Models:
Plastic Handle + Cap

Removable / Reversible Clamp Arm

Standard Pad



Replaceable Heavy Duty Pad

Self-aligning

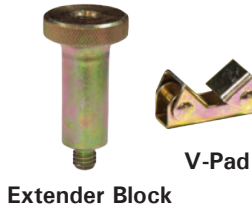

4-IN-1 ACCESSORY PACK

The 4-IN-1 Clamp Kit comes complete with the V-Pad and Extender Block accessories.

(See page 40 for details.)

Tapped Hole

For attaching accessories such as the V-Pad or Extender Block.

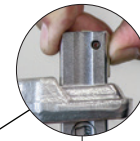
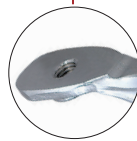

UE,UF,UG,UM Models:
Press the Spring Stop to slide the clamp arm ON & OFF



UD Models:
Remove the Key Ring.



UP Models:
Remove the Screw Stop.

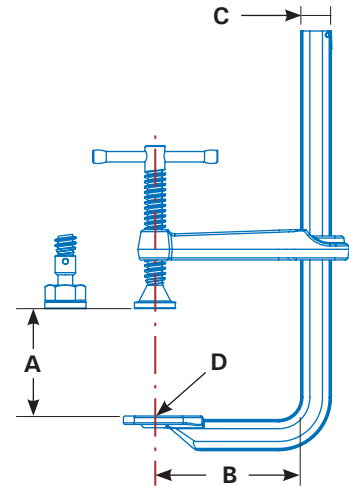

Optional Slide-on SIDEKICKS

Mount onto Clamps for the 2nd axis clamping.

(See page 40 for details.)

ONE Clamp... FOUR functions.

The strong, economical 4-IN-1 Utility Clamps adapt to serve four different applications.

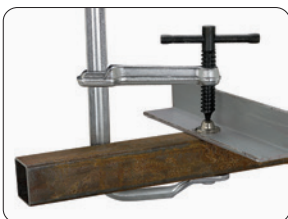

1. Standard

Sliding Arm Clamps are 10x faster than a C-Clamp!



2. Pipe

Add the exclusive V-Pad to create a Pipe Clamp!

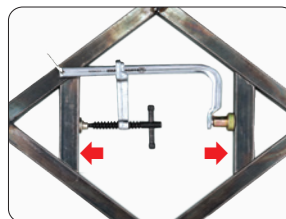

3. Spreader

Reverse the clamp arm and create a Spreader Clamp.



4. Step-Over

Add the Extender Block to create a Step-Over Clamp.

“

I've been able to replace my old set of five C-Clamps with my new 4-in-1 Clamp.”

- Mark T.



Demo Video

4-IN-1™ UTILITY CLAMPING SYSTEM

Part No.	Capacity - A (mm)	Throat Depth - B (mm)	Clamping Pressure (kg)	Pads	Rail Size - C (mm)	Tapped Hole - D	Weight (kg)
UD45M-C3	114	83	227	Standard	16 x 8	M8	0.6
UD65M-C3	165	83	227	Standard	16 x 8	M8	0.7
UF65M-C3	165	120	454	Standard	22 x 11	M10	1.3
UG85M-C3	216	120	544	Standard	25 x 12	M10	1.9
UG125M-C3	318	120	544	Standard	25 x 12	M10	2.1
UG1257M-C3	318	180 <i>*Deep Throat</i>	363	Standard	25 x 12	M10	2.9
UM85PM-C3	216	140	1,089	Standard	30 x 14	M10	3.0
UM105PM-C3	267	140	1,089	Standard	30 x 14	M10	3.4
UM125M-C3 <i>*BEST SELLER</i>	318	140	1,089	Heavy Duty	30 x 14	M10	3.5
UM165M-C3	419	140	1,089	Heavy Duty	30 x 14	M10	4.0
UM205M-C3	521	140	1,089	Heavy Duty	30 x 14	M10	4.5
UP205M-C3	521	180 <i>*Deep Throat</i>	2,177	Heavy Duty	40 x 19	M10	7.3

Utility Clamps

Utility Clamps set-up 10x faster than a C-Clamp!

HEAVY DUTY

Clamping Pressure: 2,177 kg

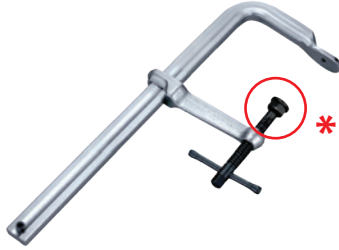

* Heavy Duty Replaceable Pads

Part No.	Capacity - A (mm)	Throat Depth - B (mm)	Clamping Pressure (kg)	Rail Size - C (mm)	Tapped Hole - D	Weight (kg)
UP125M	318	180	2,177	40 x 19	M10	5.6
UP165M	419	180	2,177	40 x 19	M10	6.2
UP205M	521	180	2,177	40 x 19	M10	6.8
UP245M	622	180	2,177	40 x 19	M10	7.5
UP405M	1,020	180	2,177	40 x 19	M10	10.0
UP605M	1,537	180	2,177	40 x 19	M10	12.7

REGULAR DUTY

Clamping Pressure: 1,089 kg



* Heavy Duty Replaceable Pads

Part No.	Capacity - A (mm)	Throat Depth - B (mm)	Clamping Pressure (kg)	Rail Size - C (mm)	Tapped Hole - D	Weight (kg)
UM65M	165	140	1,089	30 x 14	M10	2.5
UM85M	216	140	1,089	30 x 14	M10	2.7
UM105M	267	140	1,089	30 x 14	M10	2.9
UM125M	318	140	1,089	30 x 14	M10	3.2
UM165M	419	140	1,089	30 x 14	M10	3.5
UM205M	521	140	1,089	30 x 14	M10	4.0

REGULAR DUTY

Clamping Pressure: 1,089 kg

Standard Pads



Part No.	Capacity - A (mm)	Throat Depth - B (mm)	Clamping Pressure (kg)	Rail Size - C (mm)	Tapped Hole - D	Weight (kg)
UM85PM	216	140	1,089	30 x 14	M10	2.9
UM105PM	267	140	1,089	30 x 14	M10	3.0
UM125PM	318	140	1,089	30 x 14	M10	3.1

All Strong Hand Tools® Utility Clamps are made of high quality heat treated steel and nickel / chrome plated for strength and durability.



LIGHT & MEDIUM DUTY

Clamping Pressure: 230 - 544 kg
Standard Pads



UD Series with Key Ring Stop



UE, UF, UG Series with Spring Stop

Part No.	Capacity - A (mm)	Throat Depth - B (mm)	Clamping Pressure (kg)	Rail Size - C (mm)	Tapped Hole - D	Weight (kg)
UD45M	114	83	227	16 x 8	M8	0.4
UD65M	165	83	227	16 x 8	M8	0.5
UD85M	216	83	227	16 x 8	M8	0.6
UE85M	216	100	390	20 x 10	M10	1.1
UE125M	318	100	390	20 x 10	M10	1.2
UF65M	165	120	454	22 x 11	M10	1.1
UF100M	254	120	454	22 x 11	M10	1.3
UG85M	216	120	544	25 x 12	M10	1.6
UG125M	318	120	544	25 x 12	M10	1.8
UG205M	521	120	544	25 x 12	M10	2.2
UG1257M	318	180 * Deep Throat	363	25 x 12	M10	2.7
UG1657M	419	180 * Deep Throat	363	25 x 12	M10	3.0

J-CLAMP STEP-OVER



UD, UF, UG Series



UM Series

* Heavy Duty Replaceable Pads

Part No.	Capacity - A (mm)	Throat Depth - B (mm)	Clamping Pressure (kg)	Rail Size - C (mm)	Tapped Hole - D	Weight (kg)
UD45JM	114	83 (50)	227	16 x 8	M10	0.6
UF100JM	254	120 (75)	454	22 x 11	M10	1.5
UG105JM	267	120 (75)	544	25 x 12	M10	2.3
UM125JM	318	140 (120)	1,089	30 x 14	M10	3.7
UM205JM	521	140 (120)	1,089	30 x 14	M10	4.2

Ratchet Action & MagSpring™ Clamps

Quick-Set Clamps for fast, convenient clamping.

RATCHET ACTION UTILITY CLAMPS

Ratchet mechanism ensures rapid, vibration and torsion resistant clamping.

- Quick to setup, unlock, and remove in high volume clamping applications.
- Even clamping pressure. Ideal for repetitive clamping setups.

Part No.	Capacity (mm)	Clamping Pressure (kg)	Rail Size (mm)	Weight (kg)
UF65RM	180	454	22 x 11	1.2
UF100RM	254	454	22 x 11	1.3
UF100JRM	254	454	22 x 11	1.4
UG85RM	216	544	25 x 12	1.6
UG125RM	318	544	25 x 12	2.2
UG205RM	521	544	25 x 12	2.6

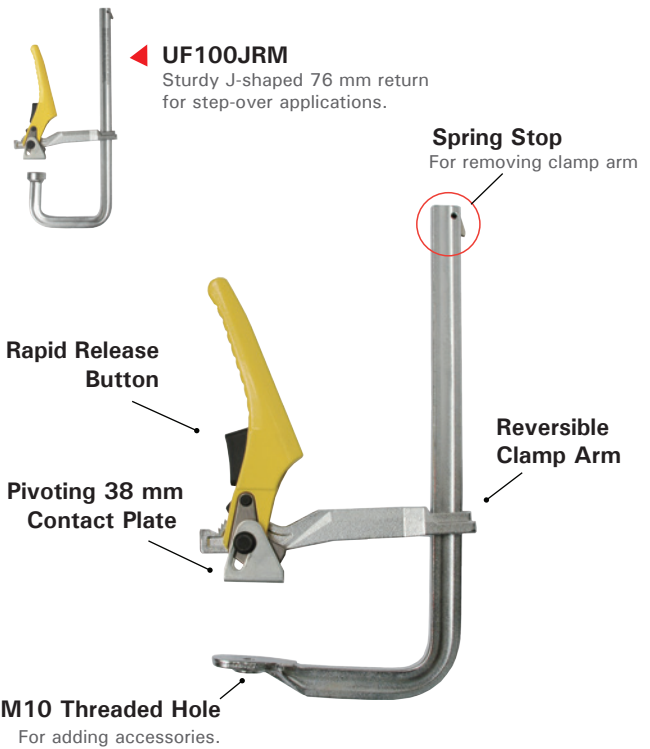

MAGSPRING™ CLAMPS

The spring-loaded, one-handed clamp with quick-set V-Pad.

The Spring Arm in conjunction with the V-Pad allows users to free up one hand to position the workpiece.

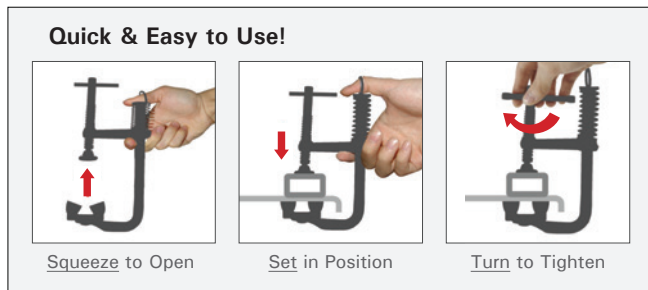
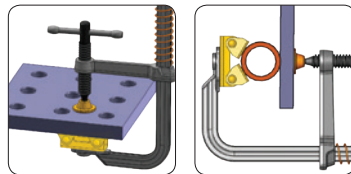

Spring Loaded Arm

The MagSpring™ holds onto metal, wood and synthetic materials.

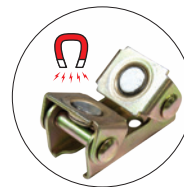

Magnetic V-Pad

Instantly adjusts for different shapes: round, flat, and angle steel surfaces.

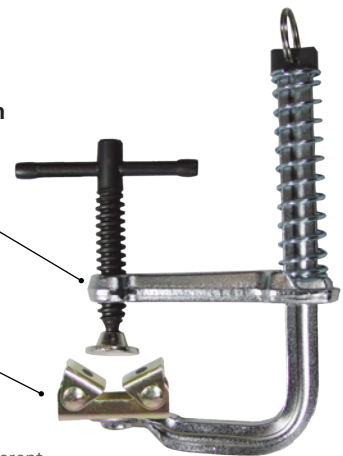

Part No.	Capacity (mm)	Throat Depth (mm)	Clamping Pressure (kg)	Tapped Hole (mm)	Weight (kg)
UBV65M	115	64	140	M6	0.4
UDV45M	75	83	227	M8	0.5
UDV65M	115	83	227	M8	0.5

Pipe Alignment and Fit-up Clamps

The efficient way to accurately fit-up round pipes for butt welding.



NEW ITEM

PIPE ALIGNMENT CLAMPS WITH QUICK-ACTING LEVER

The New Pipe Alignment Clamp with Quick-Acting Lever is a fast, accurate fit-up clamp with a rugged frame.

Get a well-balanced hold on the clamp with the two wide Grip Plates while pressing the Quick-Acting Lever. The screw smoothly glides up and down for fast jaw insertion and clamp removal after welding.

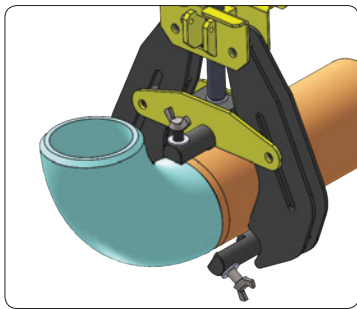

Pipe to Elbow

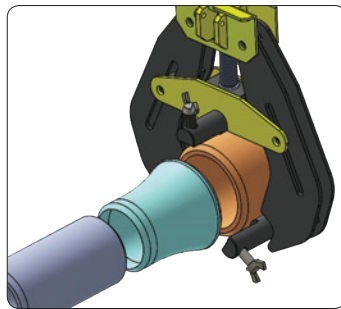

Pipe to Reducer



PRESS - SLIDE - SET

Wide Grip Plates make this Pipe Alignment Clamp easier to handle, with less user fatigue.

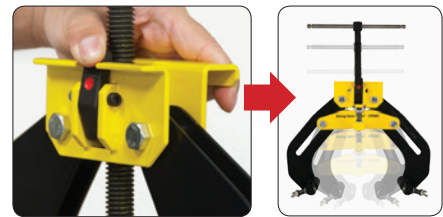

Part No.	Pipe Diameter Capacity (mm)	Weight (kg)
CPA60	50 ~ 152	5.0
CPA120	114 ~ 305	7.8

PIPE FIT-UP CLAMPS

A compact, light weight, portable clamp for the quick fit-up of round pipes and flanges for butt welding. Easy-to-Use design for the rapid, repeated loading and unloading of workpieces.

Pre-set clamp opening for fast setup:

1. Set clamp screws for your pipe diameter.
2. Move clamp forward.
3. Place second pipe and tighten.



Demo Video

Part No.	Pipe Diameter Capacity (mm)	OAL (mm)	Weight (kg)
CPL45	50 ~ 100	240	1.3
CPL75	100 ~ 140	304	2.1

All Stainless Steel Contacts
88 mm L Clamp Rods



Fine Adjustment Screws

NEW ITEM

Adjust-O™ Magnet Squares

The original magnet squares featuring On/Off switches.



It's so much easier to set-up and hold my work with the On & Off Adjust-O Magnets because I'm not fighting the magnetic force."

- Jason T.



Demo Video

ADJUST-O™ MAGNET SQUARES

The fast & easy way to hold metal workpieces at 30°/60°, 45°, and 90°.

Turn the magnet Off or at the mid-point position when setting up, turn On when you're ready to work. Fast and safe set-up!

Ideal for round and square tubing, angle, and flat stock.

Easy to clean. Simply turn Off and wipe.

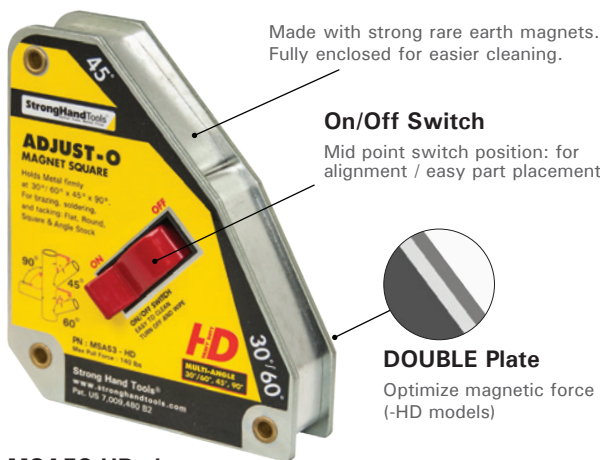
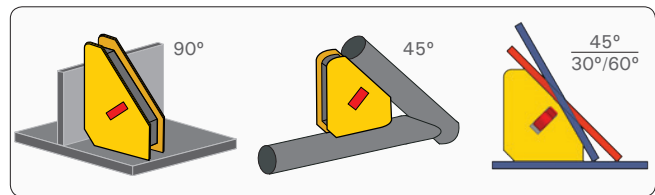

MSA53-HD shown



Part No.	Max. Pull Force (kg)	Dimension (mm)	Weight (kg)
MSA45	30	110 x 95 x 25	0.5
MSA46-HD	40	110 x 95 x 29	0.7
MSA47	35	150 x 130 x 32	1.0
MSA48-HD	75	150 x 130 x 35	1.4
MSA53-HD	65	150 x 130 x 35	1.4

*Magnetic force is based on the longest side of Magnet with 10 mm thick steel.

THIRD-AXIS MAGNETIC POSTS

Optional accessory for ALL MSA Magnets

- Quickly and easily set-up 3-sided work such as tank and gusset.
- Use on either side of the magnet squares.

MXE13



Holding a 3-Axis workpiece.

Adjust-O™ Dual Switch Magnet Squares

Angle magnet squares with the convenience of On/Off switches.

ADJUST-O™ 90° DUAL SWITCH MAGNET SQUARES

For professional jobs that demand strong hold down forces.
Holds flat and round metal work pieces.

- Two On/Off switches for independent operation.
- Turn the magnets Off when setting up, turn On when you're ready to work. Easy and safe set-up!
- Machined flat and V-surfaces are ideal for round and square tubing, angle, and flat stock.
- Choose from 55 - 120 kg pull force.



Part No.	Max. Pull Force (kg)	Dimension (mm)	Weight (kg)
MS2-80	55	152 x 152 x 38	1.2
MS2-90	120	197 x 197 x 48	2.7

*Magnetic force is based on 10 mm thick steel.

ADJUST-O™ ANGLE MAGNET

- Adjustable from 30° - 275° with two On/Off switches.
- Machined flat surfaces and nickel/chrome body.
- V-Groove surfaces securely hold round and square tubing, angle, and flat stock.



Machined V-Groove
For holding round & flat stock.



Calibration w/ Vernier



2 x ON/OFF Switch

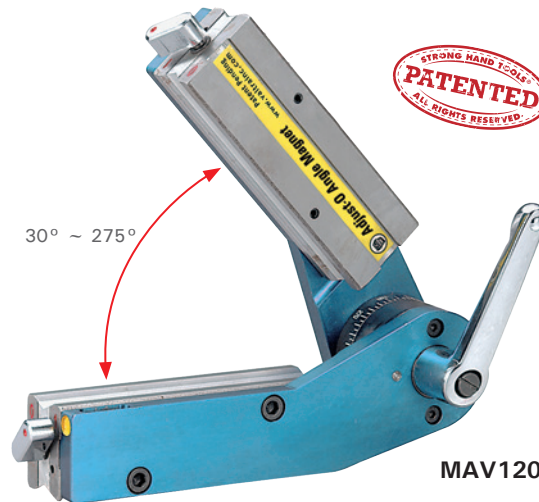

Part No.	Angles	Max. Pull Force (kg)	Dimension (mm)	Weight (kg)
MAV120	30° ~ 275°	50	197 x 197 x 95	2.4

*Magnetic force is based on 10 mm thick steel.

Heavy Duty & Multi-Angle Magnets

Tools for sheet metal and large stock holding.

A-FRAME HD MAGNET

New for large and heavy stock holding.

Larger / wider magnets with large contact surface and stability. ON/OFF switches function with weaker force when lever at **mid-position**, for adjustment / placement of parts.



Part No.	Max. Pull Force TOTAL (kg)	Dimension (mm)	Weight (kg)
MS2-300	120	330 x 330 x 32	4.0

STANDARD MAGNET SQUARES

Holding at multiple angles while soldering, brazing, and welding at 30°/60°, 45°, and 90°.

- Center hole for easy handling.
- Aluminium enclosed for easier cleaning.



MS346C
Multi-Angle



MS45
45°, 90°



MS60
60°, 90°



Part No.	Angles	Max. Pull Force (kg)	Dimension (mm)	Weight (kg)
MS346C	30°/60°, 45°, 90°	40	113 x 98 x 23	0.8
MS45	45°, 90°	30	113 x 98 x 19	0.5
MS60	60°, 90°	25	113 x 98 x 19	0.5

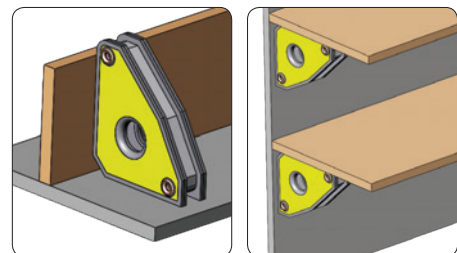

*Magnetic force is based on the longest side of Magnet with 10 mm thick steel.

Mini & XYZ Magnet Squares

Unique 30°/60°, 45° and 90° angle combination.



MINI MAGNET SQUARES

- Mini Magnets at just 58 mm in height provide low profile holding of stock in tight, hard to reach areas.
- Use as many as needed for light duty holding of stock at multiple points.
- Insert a screwdriver into the center hole to apply breakaway force.
- Full aluminum rim enclosure for easy cleaning.



MS346AT
Mini Multi Angle



MS350A
Multi-Angle



Avoid prolonged exposure of magnetic products to heat sources of 356°F / 180°C.

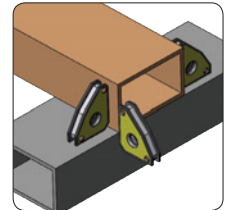
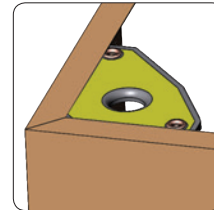
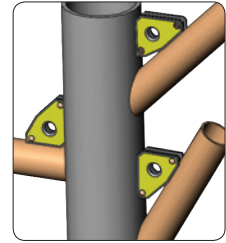
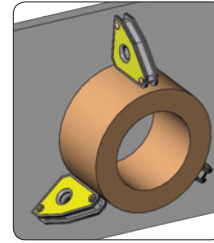

Part No.	Angles	Max. Pull Force (kg)	Dimension (mm)	Weight (kg)
MS346AT (Twin Pack)	30°/60°, 45°, 90°	10	59 x 50 x 16	0.3
MS346AK (6-Pack)	30°/60°, 45°, 90°	10	59 x 50 x 16	0.8
MS350A	30°/60°, 45°, 90°	13.6	86 x 75 x 16	0.3

*Magnetic force is based on the longest side of Magnet with 10 mm thick steel.

XYZ MAGNET SQUARES

- Quickly & easily set-up 2 or 3-Axis workpieces, such as gussets and steel panels.
- Unique Magnetic Face Plate features two rare earth disc magnets for 3rd axis holding.
- **Rotate** and **slide** Magnetic Face Plate into position as needed for each unique applications.
- Use the face plate as an edge guide when joining square tubes and sheet metal.



Front Back
MST348

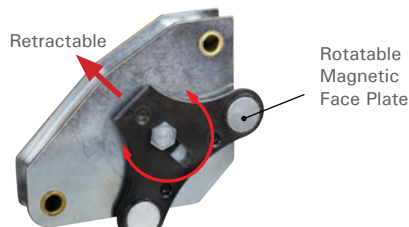

MS350

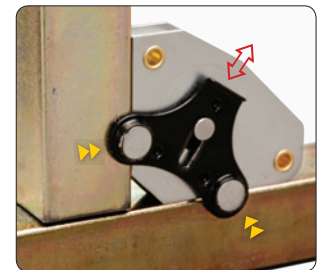

The face plate can be slid out of the boundary edges as edge guide.



Gusset Holding

Part No.	Angles	Max. Pull Force (kg)	Dimension (mm)	Weight (kg)
MST348 (Twin Pack)	30°/60°, 45°, 90°	10	59 x 50 x 22	0.3
MS350	30°/60°, 45°, 90°	13.6	86 x 75 x 16	0.3

*Magnetic force is based on the longest side of Magnet with 10 mm thick steel.



Great tool for any welder / fabricator who deals with small parts that are hard to locate accurately."

- James



Demo Video

The accurate, faster way to hold tabs in place for tack welding!

- Hold tabs, or any small metal pieces, parallel or perpendicular to the substructure.
- The Adjustable Magnetic V-shape base adjusts for different shapes: round, flat, angle metal surfaces.
- Remove the MagTab bracket to use the Adjustable Magnetic V-Pad for light duty holding of steel plates.

NEW ITEM



MNT15
(JUMBO)

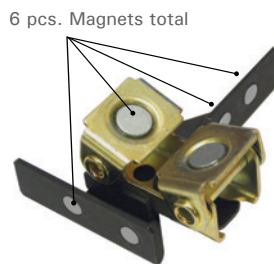

MFT10

6 pcs. Magnets total

STRONGER FOR LARGER PARTS

Part No.	Dimension (mm)	Max. Pull Force (kg)	Weight (kg)
MNT15	130 x 110 x 48	15	0.5
MFT10	100 x 76 x 32	8	0.2

*Magnetic force is based on 10 mm thick steel.

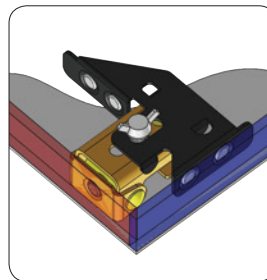

Box Lid

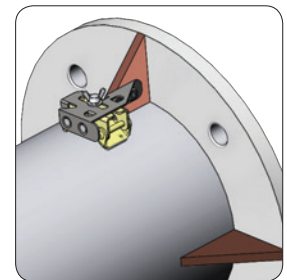

Gussets

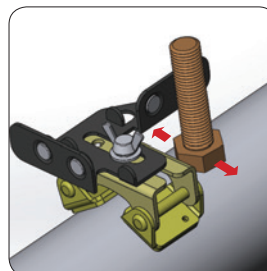

Bracket Adjustment

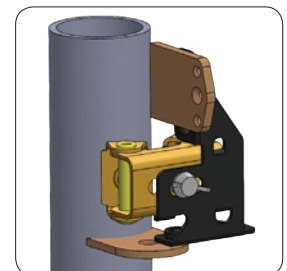

Parallel / Perpendicular Tab

New TWIN PACK Kits:

Part No.	Kit Contents	Weight (kg)
MNT28	2 x MNT15	1.0
MFNT27	MFT10 + MNT15	0.7
MFT23	2 x MFT10	0.5

Remove the MagTab bracket...

See page 15 for more applications.

Also see page 31 for our NEW magnetic grasshopper.

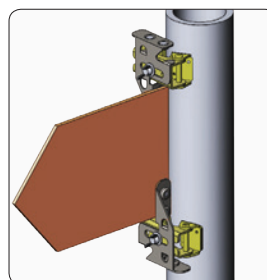

Sign

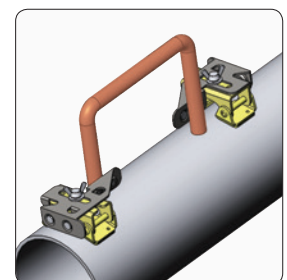

Handle

MagRest™ & MagHold™ V-Pad Kits

Time saving magnetic tools for use in the shop & in the field.



NEW ITEM

MagRest™ V-PAD KIT

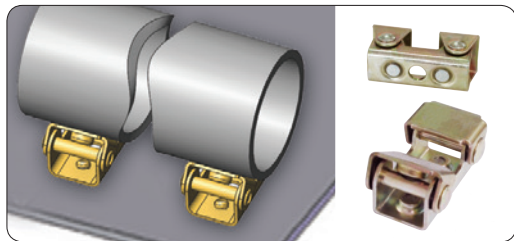

MVDF42

Magnets on the bottom only.

(XDV3)
Max. Pull Force: 3 kg.

(XFV3)
Max. Pull Force: 4 kg.

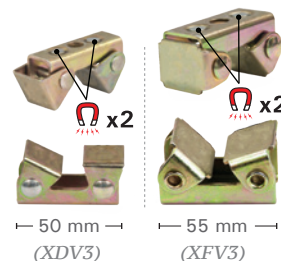

MagHold™ V-PAD KITS

Light duty & tight spot holding! Build, Hold, and Position Steel.

Hold and position round, flat, and square parts in light duty substructure applications!

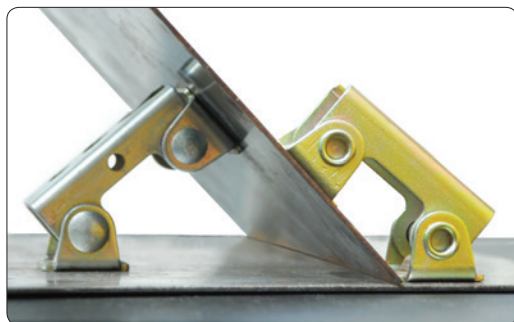

THREE 4-PC. KITS TO CHOOSE FROM:

MVDF44

Magnets on both pad face and the bottom.

(XDV4)
Max. Pull Force: 6 kg.

(XFV4)
Max. Pull Force: 8 kg.

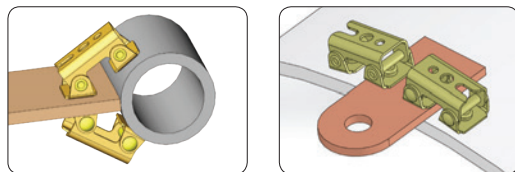
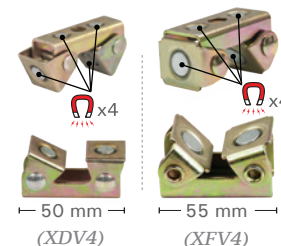

MVFN46

Magnets on the pad face only.

(XFV2)
Max. Pull Force: 8 kg.

(XNV2)
Max. Pull Force: 16 kg.

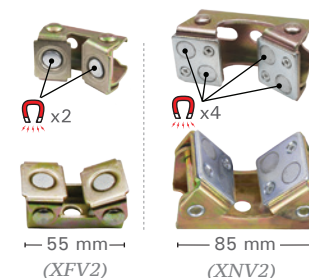

MVNP48

Magnets on the pad face only.

(XNV210)
Max. Pull Force: 16 kg.

(XPV830)
Max. Pull Force: 30 kg.

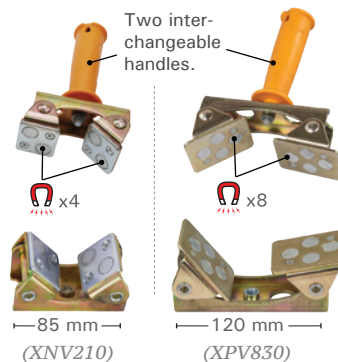

NEW ITEM

NEW ITEM

Part No.	Description	Kit Contents	Weight (kg)
MVDF42	MagRest	2 pcs. V-Pads (XDV3) + 2 pcs. V-Pads (XFV3)	0.3
MVDF44	MagHold	2 pcs. V-Pads (XDV4) + 2 pcs. V-Pads (XFV4)	0.4
MVFN46	MagHold	2 pcs. V-Pads (XFV2) + 2 pcs. V-Pads (XNV2)	1.1
MVNP48	MagHold	2 pcs. V-Pads (XNV210) + [2 pcs. V-Pads + 2 pcs. plastic handles (XPV830)]	2.0

*Magnetic force is based on the longest side of Magnet with 10 mm thick steel. See page 41 for individual V-Pad details.

MagHold™ Extendable Arm & Snake Magnets

Time saving magnetic tools for use in the shop & in the field.

NEW ITEM

MagHold™ EXTENDABLE ARM

Position and hold steel stock in welding and fabrication.

- Telescoping mounting bar adjusts from 163 mm to 238 mm in length.
- Loosen the center joint in the mounting bar to “fold up” the MagHold for different workholding configurations.
- Adjustable magnetic V-Pads at each end hold stock of different shapes: round, flat, angled.

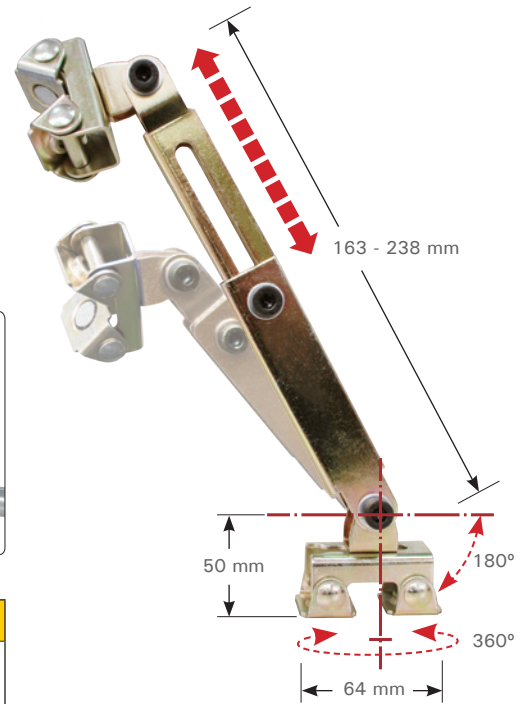

Part No.	Max. Pull Force (kg)	Weight (kg)
MHF608	8	0.6

SNAKE MAGNETS

The Third Hand - Holds, Bends, Twists



The Snake Magnet gives you the flexibility to hold stock at odd angles. Spring Clamp can be used as the third hand to hold tools.

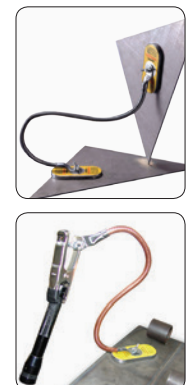
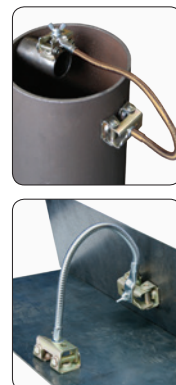

Part No.	Description	Weight (kg)
MFC312	305 mm flex cable, 1 clamp, 2 Adjustable Magnetic V-pads	0.5
MFC318	450 mm flex cable, 1 clamp, 2 flat Magnetic Pads	0.6

*Magnetic force is based on 10 mm thick steel.

Sheet Metal Magnets & Corner Magnets

Ideal for positioning and holding sheet metal for butt welding.



SHEET METAL MAGNETS

Hold sheet metal and automotive metal panels firmly in a positive location for cutting, welding, tacking, painting and repair operations.

Rare earth disc magnets in the magnetic plate have superior gripping power. Rubber Pads on the Sheet Metal Magnets provide friction for increased drag force in sheet metal handling applications.

Use horizontally or vertically. The strong, generously sized plastic handle makes placing, moving, and removing the Sheet Metal Magnets fast and easy.



◀ 83 mm Dia.

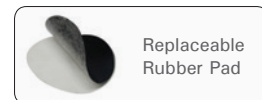

Part No.	Description	Straight Pull Force (kg)*	Side Drag Force (kg)*	Weight (kg)
MSM61	Light Duty Sheet Metal Magnets (Single piece) with 2 replaceable Rubber Pads	18	13	0.3
MSM71	Medium Duty Sheet Metal Magnets (Single piece) with 2 replaceable Rubber Pads	27	17	0.3
MSM81	Heavy Duty Sheet Metal Magnets (Single piece) with 2 replaceable Rubber Pads	45	20	0.3
MCB82	Heavy Duty Sheet Metal Magnets (Twin Pack of MSM81)	45 / ea.	20 / ea.	0.5
MCB802	10 pcs. Replaceable Rubber Pad	--		0.1

* Subject to surface thickness and texture.



CORNER MAGNETS

- Create 90° corners by holding from the outside, providing you with an unobstructed area for inside tack welds.
- One side corner "relief" provides clearance for tall lips.
- Use the outer edges of the Corner Magnet for setting up materials at 60°.

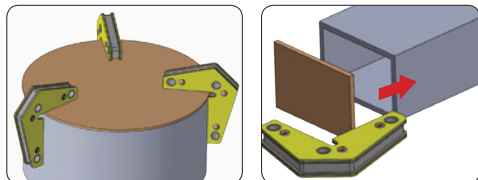

The compact and low profile Corner Magnet is ideal for light duty holding of stock at 90°.



Use the outer edges of the Corner Magnet to hold stock at 120°.

Part No.	Description	Dimension (mm)	Max. Pull Force (kg)	Weight (kg)
MST327	Twin Pack 90° & 60°	83 x 95 x 16	14	0.4

*Magnetic force is based on the longest side of Magnet with 10 mm thick steel.

Inside Outside Angle Magnets

Hold stock using the Inside or Outside edges!

NEW ITEM

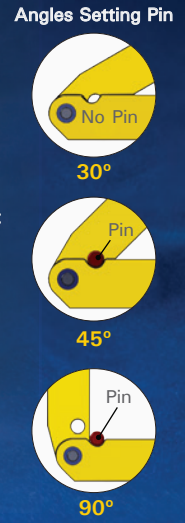

*** PATENT PENDING ***

Hold stock from the outside when inside access is difficult.

Hold and position sheet metal, round pipes, square, angled or flat stock.

The Inside / Outside Angle Magnets are constructed from two independent rectangular magnets for consistent, undiminished magnetic force when both sides are attached to workpieces.

Use mounting holes to link two magnets together for use as fixturing elements.

Use hex hole on magnet for breakaway leverage.



Demo Video



Part No.	Angles	Height (mm)	Width (mm)	Thickness (mm)	Mag. Pull Force (kg)	Weight (kg)
MLDT350 COMBO PACK: (MLD300) + (MLD500)						0.5
1pc. (MLD300)	90°, 30°/60°	76	52	14	9	
1pc. (MLD500)	90°, 30°/60°	125	85	18	15	
MLD600	90°, 30°/60°	165	110	20	18	0.8
MLA450	30 ~ 270°	120	120	18	12	0.5
MLA600	30 ~ 270°	156	156	20	15	0.9

Grinder Rests & MIG/TIG Gun Holders

Time saving magnetic tools for use in the shop & in the field.



GRINDER RESTS

Store your Grinder and all accessories on one convenient, compact, portable rest for easy access. The Grinder Rest holds most 125 mm Grinders. No more searching for wrenches or spare discs!



Demo Video

Magnetic Base Model

MGH4510

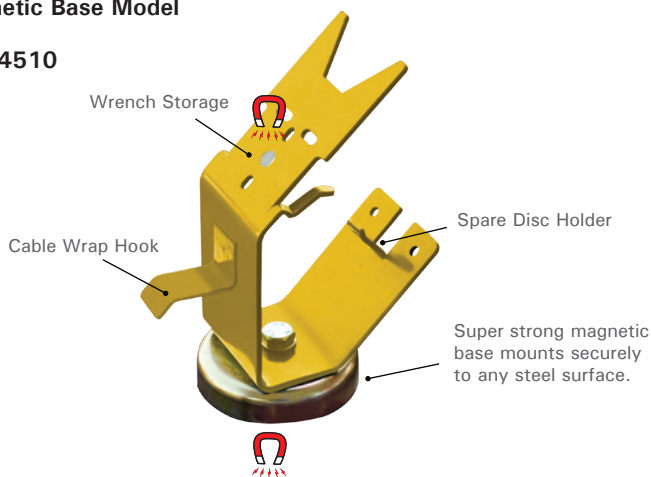

Part No.	Description	Weight (kg)
MGH4510	Magnetic base model	1.1
MGK53	C-Clamp base model w/ Adaptor Plate	1.0

C-Clamp Base Model

MGK53

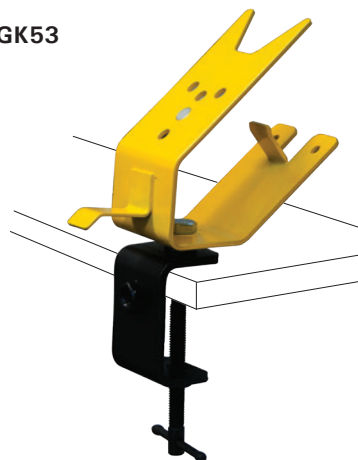

* Includes Adaptor Plate for table leg and beneath table edge Mounting!



MIG / TIG GUN HOLDERS

Handy Accessory Plate (included with Part Nos. MRM12) features a slot for MIG Pliers and a Nozzle Gel Canister.

Fully enclosed Magnetic Base allows easier clean up of metal fuzz.

Part No. MRM13 Kit contains the MIG Gun Holder (MRM12), and MIG Pliers (PM08).

Part No.	Description	Weight (kg)
MRM12	MIG Gun Holder with Accessory Plate	1.3
PM08	MIG Pliers	0.3
MRM13	MIG Gun Holder with Accessory Plate & MIG Pliers	1.5
MRT15	TIG Gun Holder	0.8

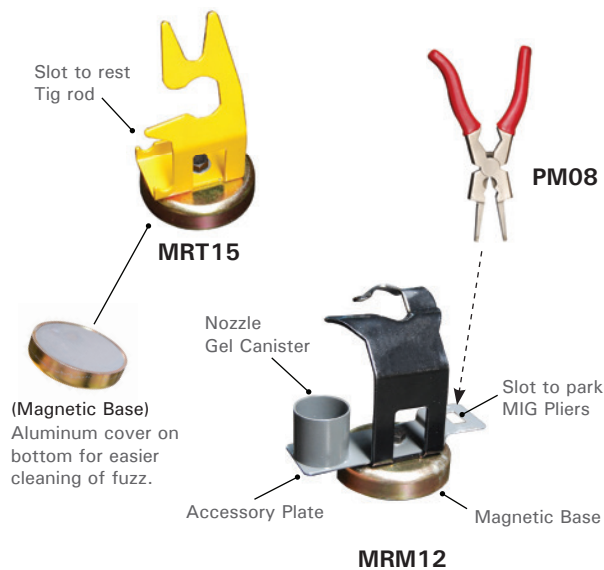

Big Mouth Pliers

Adjust instantly to hold large or small workpieces



Four Adjustment Slots - Large Capacity

- Unique crank handle for FAST opening, closing and in-situ pressure adjustment.
- Serrated jaw surfaces for extra gripping power.
- V-Notch on top jaw for holding small parts.
- Long jaw (64 mm) for extra capacity and greater versatility in workholding.
- Keep this versatile tool on hand for fast clamping in a variety of jobs!

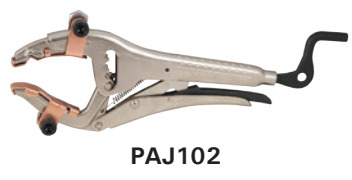

Soft Copper Jaw

Clamp + Protect soft or fine surfaces. Compatible with Stainless Steel and Aluminum.

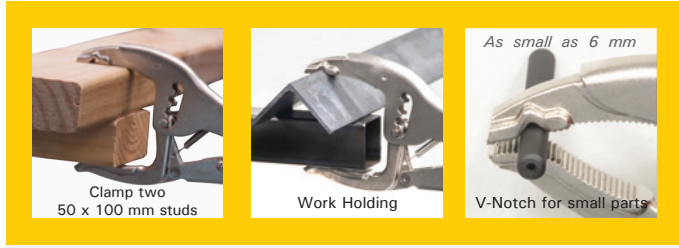

Copper Grounding

Clamp + Ground thick, thin, & round parts with tight pressure for good contact. Grounding ribbon connects top & bottom jaws.

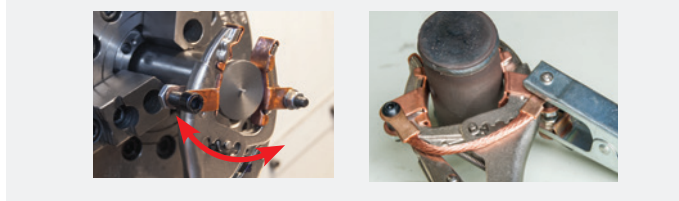

Part No.	Description	Opening (mm)	Throat Depth (mm)	OAL (mm)	Weight (kg)
PAJ100	Standard Model	6 ~ 75	64	250	0.7
PAJ102	Soft Copper Jaw	6 ~ 75	64	250	0.9
PAJ207	Copper Grounding	6 ~ 75	64	250	1.0



** PATENT PENDING **

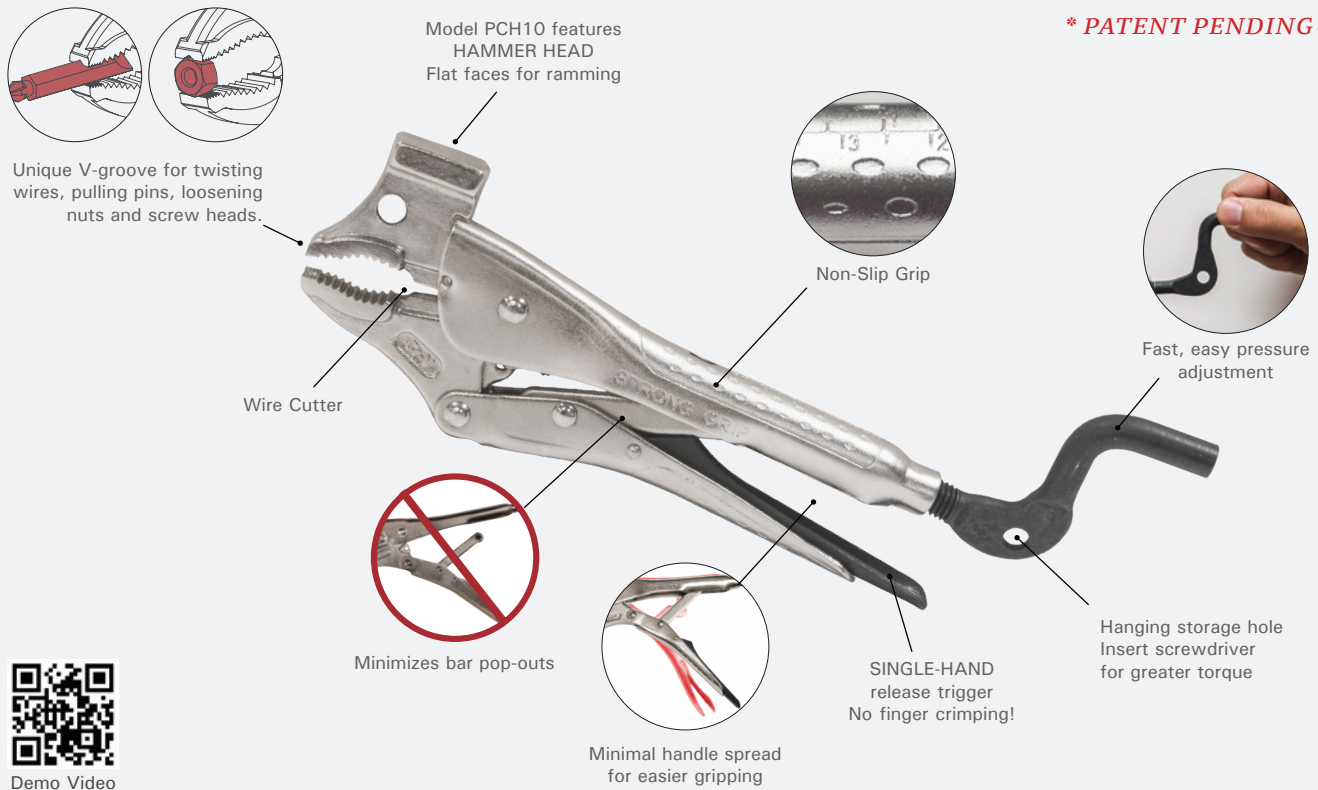

Unique and Convenient!

C-JAW PLIERS WITH HAMMER HEAD

Unique design provides a convenient hammer when you need it, where you need it!



Part No.	Opening (mm)	OAL (mm)	Weight (kg)
PCH10	40	300	0.6

C-JAW PLIERS

The most popular grip pliers with improved features:

Machined curved jaws with serrated teeth tightly grip round stock as well as a variety of shapes.



Part No.	Opening (mm)	OAL (mm)	Weight (kg)
PCJ50	26	180	0.2
PCJ70	40	245	0.4
PCJ100	41	300	0.6
PCJ120 *	55	360	0.9

** Unique larger size.*

Strong Grip® Pliers

The Easiest to GRIP, ADJUST, RELEASE.

UNIQUE

DUAL AXIS PULL PLIERS W/ HAMMER HEAD

An essential pulling, pushing, ramming tool for the die-maker, maintenance craftsman, and auto repair shop mechanic. Pull Rod mounts in the swing handle, or in the M10 threaded hole for 2-axis pulling or pushing.

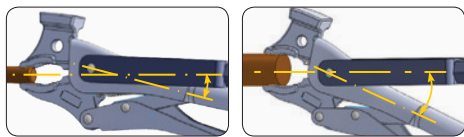
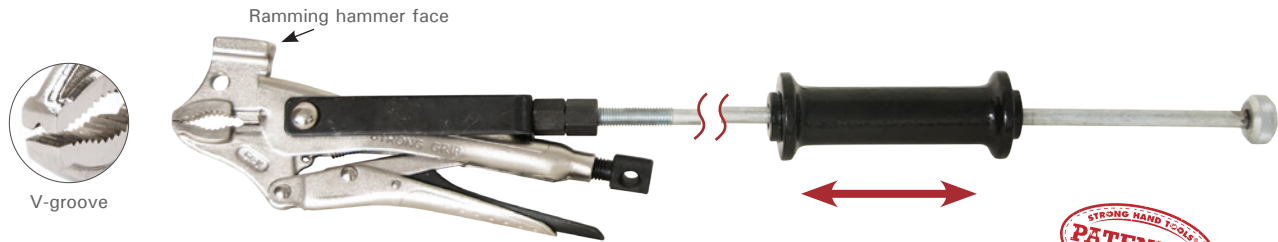

SELF Aligning pull bar
accommodates different part thickness



Side Pull

Part No.	Opening (mm)	OAL (mm)	Weight (kg)
PPD100	40	715	3.8

ECONOMY PIPE PLIERS

Large Capacity (75mm)! Holds round, square, flat or angled. The large (Ø38 mm) swivel pad makes alignment easier!

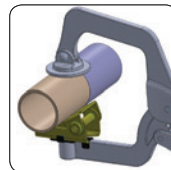

Part No.	Opening Round / Square (mm)	OAL (mm)	Weight (kg)
PVS100	up to 75	360	1.0

LOCKING CHAIN PLIERS

Clamp odd shaped multiple items. **Adjust tension with crank handle.**

Replaceable chain available in 600mm (P/N: PXC24), 910 mm (P/N: PXC36) & 1,200 mm (P/N: PXC48) lengths.



Part No.	Chain Length (mm)	Holds Pipes (mm)	Weight (kg)
PFC1024	600	up to 165	0.9
PFC1036	910	up to 270	1.1
PFC1048	1,200	up to 360	1.4

VERSATILE · HANDY!

PLIERS W/ COMBO TIPS

One round tip for tight spots + swivel pad for larger surface contact.

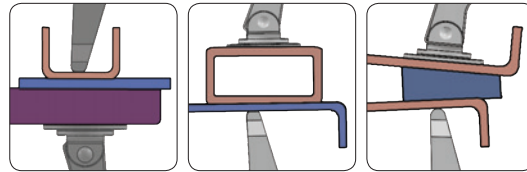

Part No.	Throat Depth (mm)	Opening (mm)	OAL (mm)	Pad Size (mm)	Weight (kg)
PSR80	76	60	300	29	0.6
PSR100	76	70	360	38	0.8
PSR140	142	127	430	38	1.1

UNIQUE

PLIERS W/ ROUND TIPS

Greater clearance and access for quick holding in tight areas.

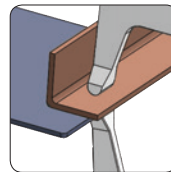

Part No.	Throat Depth (mm)	Opening (mm)	OAL (mm)	Weight (kg)
PRB60	42	48	192	0.3
PRB80	76	60	290	0.6
PRB110	76	75	350	0.9
PRB140	142	95	410	0.9

UNIQUE

PLIERS W/ SWIVEL PADS

Hold angled, or uneven work pieces, without damaging surfaces. Pads pivot to align with the work surface for a firm hold.

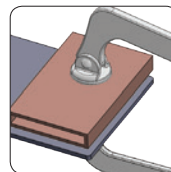

Part No.	Throat Depth (mm)	Opening (mm)	OAL (mm)	Pad Size (mm)	Weight (kg)
PSB60	52	48	208	22	0.3
PSB80	76	60	290	29	0.6
PSB110	76	75	350	29	0.9
PSB140	142	120	415	29	1.0

Strong Grip® Pliers

The Easiest to GRIP, ADJUST, RELEASE.

U-PRONG PLIERS

Wide U-Shaped jaw for workpiece visibility, weld access, secure holding.

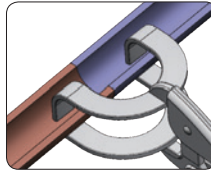

Part No.	Opening (mm)	OAL (mm)	Weight (kg)
PUP90	50	275	0.6
PUP100	80	340	0.9

SHEET METAL PLIERS

Wide, robust contact plates provide a powerful hold on stock.

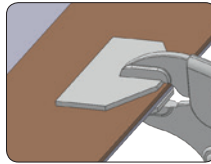

Part No.	Parallel Opening (mm)	OAL (mm)	Weight (kg)
PDB80	10	250	0.5
PDB90	15	320	0.8

LONG NOSE PLIERS

Long, slim nose for access in tight, narrow, hard to reach areas.

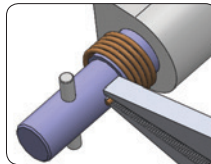

Part No.	Parallel Opening (mm)	OAL (mm)	Weight (kg)
PLN50	5	205	0.2
PLN90	6	270	0.4

BENCH-MOUNT PLIERS HOLDER

Convenient storage, or hands-free use

Holds in Vertical & Horizontal positions.

Wing nuts on both vertical and horizontal position locks pliers in place.

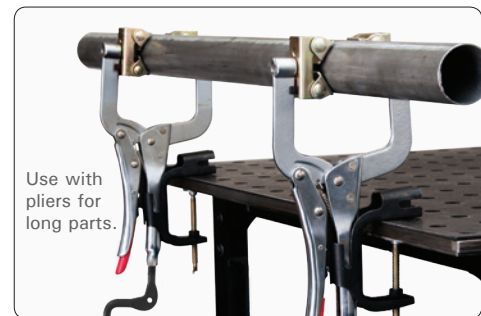

Part No.	Weight (kg)
PB11	0.1

Pipe Pliers

The convenient way to hold round or square tubes for butt-welding.

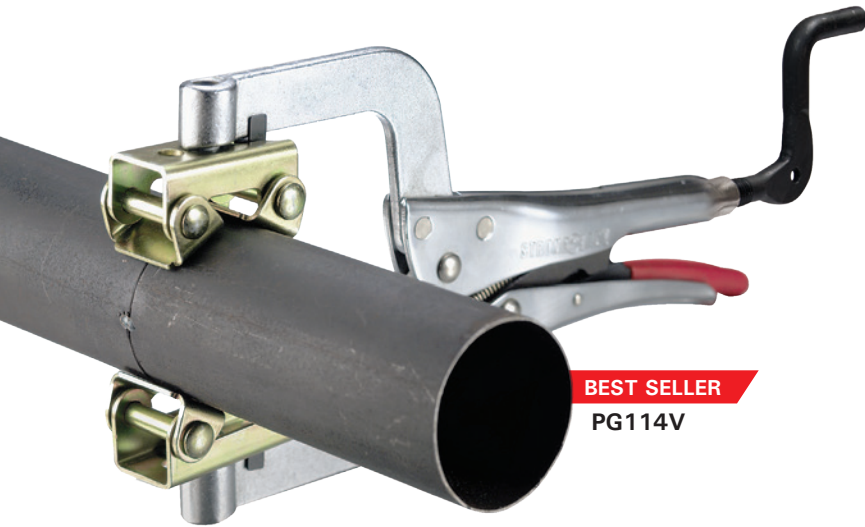

- Wide opening allows the Pipe Pliers to hold up to 64 mm diameter pipes.
- 2 large V-Pads provide a better clamping surface.
- Adjustable top spindle for holding pipes of varying sizes.
- 0° & 45° angle clip allows angled clamping.

The V-Pads on the Pipe Pliers adapt to many different shapes and sizes.

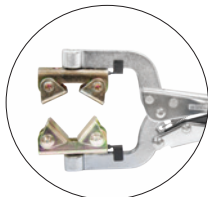
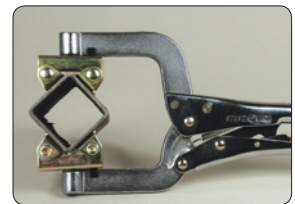

PG622V
PG634V
PG114V

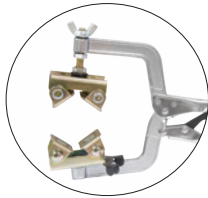

PG635V
PG635VS

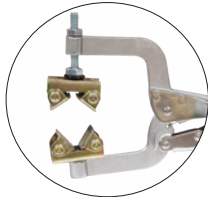

PG115V

* Magnetic V-Pads and Stainless Steel V-Pads also available separately.
See page 41 for details.

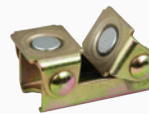

XFVS
Stainless Steel V-Pads
for PG635VS

Part No.	Top V-Pad	Bottom V-Pad	Throat Depth (mm)	Opening (mm)	Thread	OAL (mm)	Weight (kg)
PG622V	Fixed	Fixed	50	25 - 50	M8	150	0.4
PG634V	Fixed	Fixed	76	50 - 80	M8	216	0.5
PG635V	Adjustable	Magnetic 0° & 45° rotatable	76	38 - 64	M8	216	0.5
PG635VS	Adjustable <i>Stainless Steel</i>	<i>Stainless Steel</i> 0° & 45° rotatable	76	38 - 64	M8	216	0.5
PG114V	Fixed	Fixed	89	38 - 64	M10	280	1.3
PG115V	Adjustable	Fixed	89	38 - 64	M10	280	1.3

Locking C-Clamps

Improved features for professionals and Do-It-Yourselfers.

Made of heat treated steel and nickel/chrome plated for strength and durability. Updated features help you work quickly, safely and efficiently.

Round Tip Model

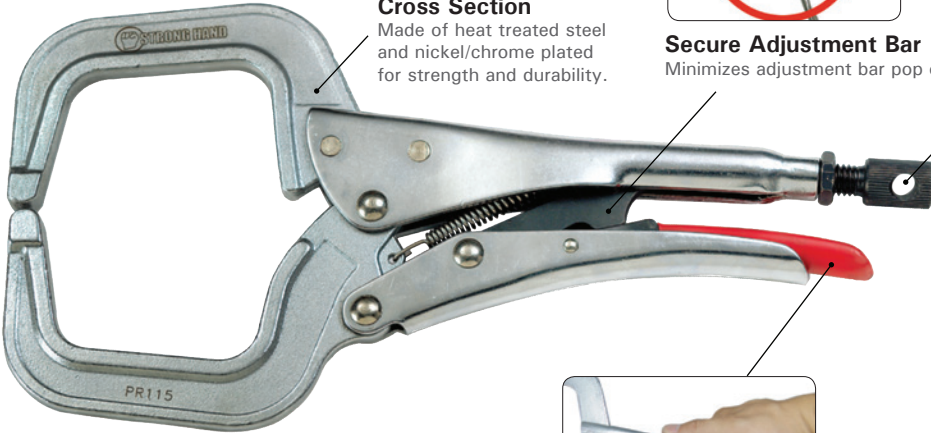

Cross Section
Made of heat treated steel and nickel/chrome plated for strength and durability.

Secure Adjustment Bar
Minimizes adjustment bar pop outs.

Adjustment Screw
Large adjustment screw with a hole for easy torque.

Optional Crank Handle
See page 40 for details.

Single Hand Release Handle
Vinyl coated release handles made for comfort and ease.

PR115

Swivel Pad Models



PR115S **PR18S**

	Part No.	OAL (mm)	Throat Depth (mm)	Opening (mm)	Weight (kg)
Round Tip	PR6	165	46	56	0.2
	PR115	280	83	100	0.9
	PR18	450	254	114	1.4
Swivel Pad	PR6S	165	46	56	0.3
	PR115S	280	83	100	1.0
	PR18S	450	254	114	1.4

Multi-Purpose & Long Reach Pliers

Swivel and fixed head spindles for flexibility in clamping.

MULTI-PURPOSE PLIERS

One swivel pad spindle and a fixed head spindle for flexible clamping. Threaded jaw holes allow addition of accessories.

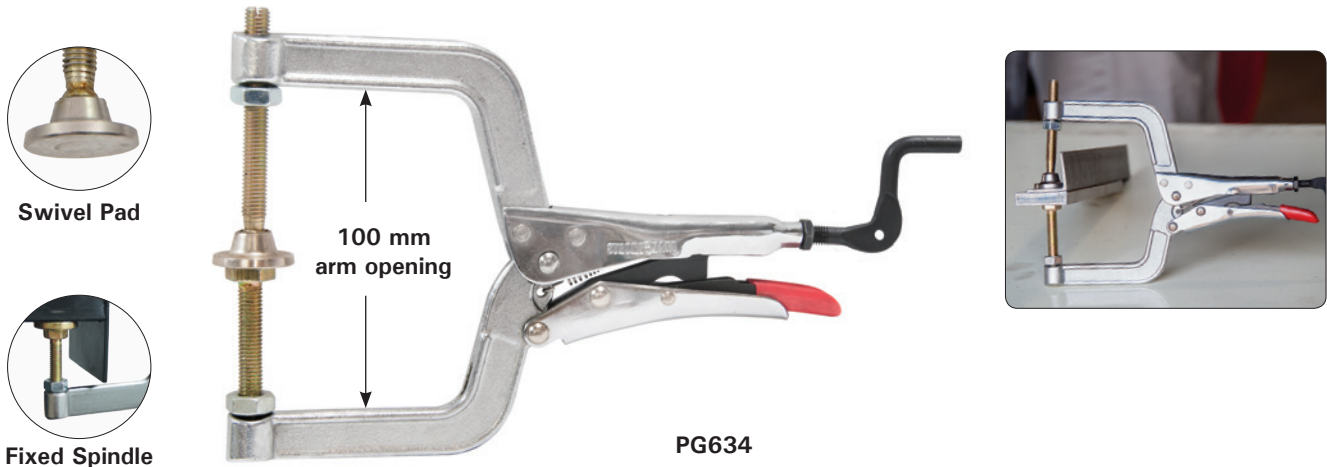

Part No.	OAL (mm)	Throat Depth (mm)	Opening (mm)	Thread	Weight (kg)
PG634	216	76	100	M8	0.5
PG114	280	89	100	M10	0.9

ADJUSTABLE REACH AND LONG REACH MULTI-PURPOSE PLIERS

Thread : M10 | Opening : 100 mm



PGA20M - Adjustable Reach Arms

Top Adjustable Spindle: No-mar rubber pads, pivoting head.
Bottom Adjustable spindle: No-mar rubber pads, fixed head.



PGA20M

PGA20S - Adjustable Reach Arms, with top and bottom fixed jaws, pivoting heads, and no-mar rubber pads.



PGA20S

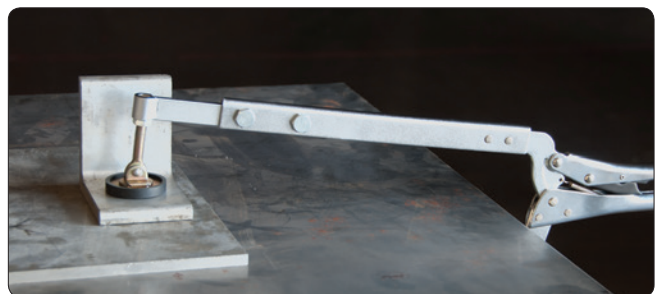

Part No.	OAL (mm)	Throat Depth (mm)	Weight (kg)
PGA20M	585 - 740	350, 405, 460, 510	2.2
PGA20S	585 - 740	350, 405, 460, 510	2.2

JointMaster™ Angle Clamping Tools

Fast, precise and affordable clamping tools for corners and T-joints.

PL634

The **single-hand** JointMaster™

- Ideal for quick hold and release on metal, wood & synthetic materials.
- A "helping hand" to hold stock firmly at right angles.
- Comes with 1 pair of pliers.

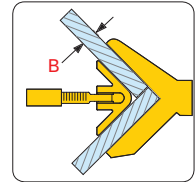
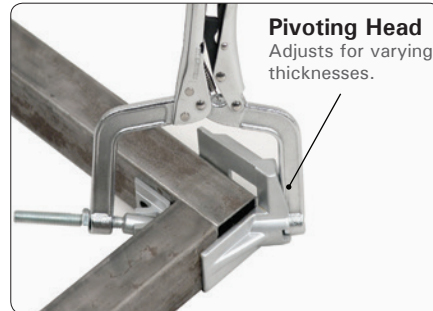

Capacity (B):
PL634 : 0 - 32 mm

PT634

The **90° Fixed** JointMaster™

- Retractable plate for edge alignment
- V-Grooves for holding round pieces.
- Ideal for holding two pieces of different thicknesses that require individual adjustments.
- Comes with 2 pairs of pliers.

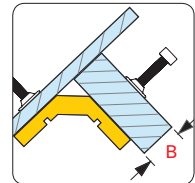
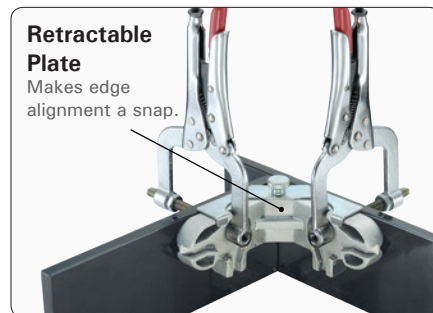

Capacity (B):
PT634 : 0 - 76 mm

PA634

The **Adjustable** JointMaster™

- Adjustable from 30° - 275°.
- Adjust to the desired angle & "lock" into position with the handle.
- Join round & flat workpieces, or materials with different thicknesses.
- Comes with 2 pairs of pliers.

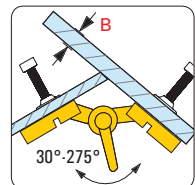

Capacity (B):
PA634 : 0 - 76 mm

PL / PT / PA Series

Spring-loaded top spindle + easy trigger + PATENTED crank handle

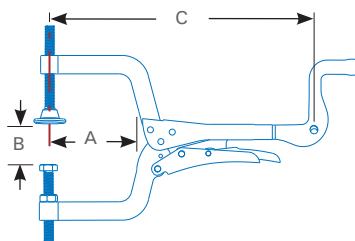

Part No.	Throat Depth (A) (mm)	Max. Capacity (B) (mm)	OAL (C) (mm)	Weight (kg)
PL634	76	32	216	0.5
PT634	76	76	216	1.1
PA634	76	76	216	1.1

3-Axis Clamping Kit & Expand-O Pliers

The flexibility to clamp around odd shaped items!



NEW ITEM

PORTABLE 3-AXIS CLAMP KIT

Kit includes: Spring Loaded L Clamp w/ 3-Axis Bracket + Pipe Pliers

- Light and easy to use. Set up 3-Axis stock before tack welding.
- Wide opening provides unobstructed welding access.
- **Pipe Pliers [included]** holds 3-axis stock in position; 38 - 64 mm capacity. 216 mm OAL.

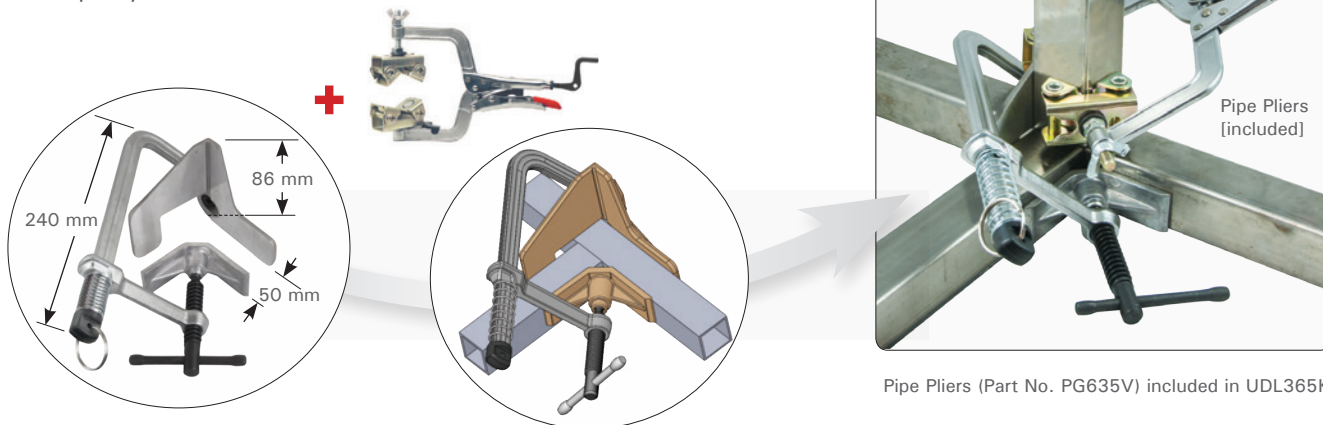

Pipe Pliers (Part No. PG635V) included in UDL365K

Part No.	Description	Weight (kg)
UDL365K	Kit includes: Spring Loaded L Clamp w/ 3-Axis Bracket (UDL365) + Pipe Pliers	1.4

EXPAND-O PLIERS

Unique, Reverse-Action Clamping Pliers!
Jaws move in opposite directions to push against two surfaces.

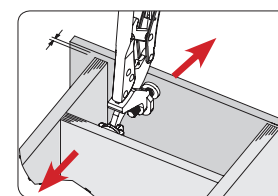
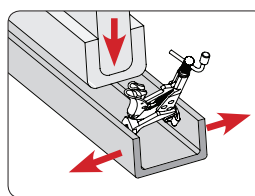
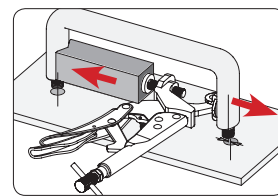
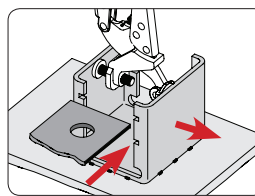
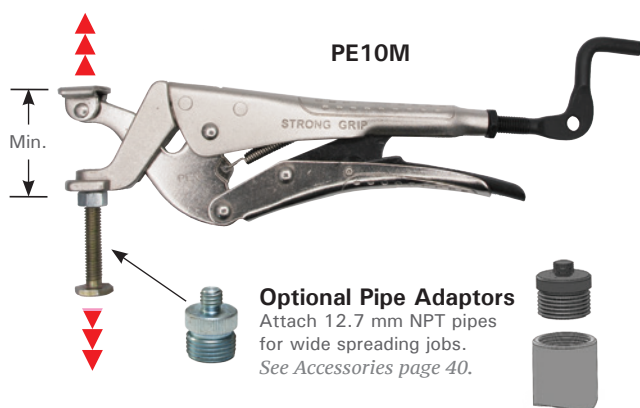

Part No.	OAL (mm)	Clamping Pressure (kg)	Thread (mm)	Min. (mm)	Stroke (mm)	Weight (kg)
PE6M	165	227	M8	25	19	0.2
PE10M	254	410	M10	35	35	0.8

The Third Hand Modular Clamps

FULLY articulated, FULLY adjustable.

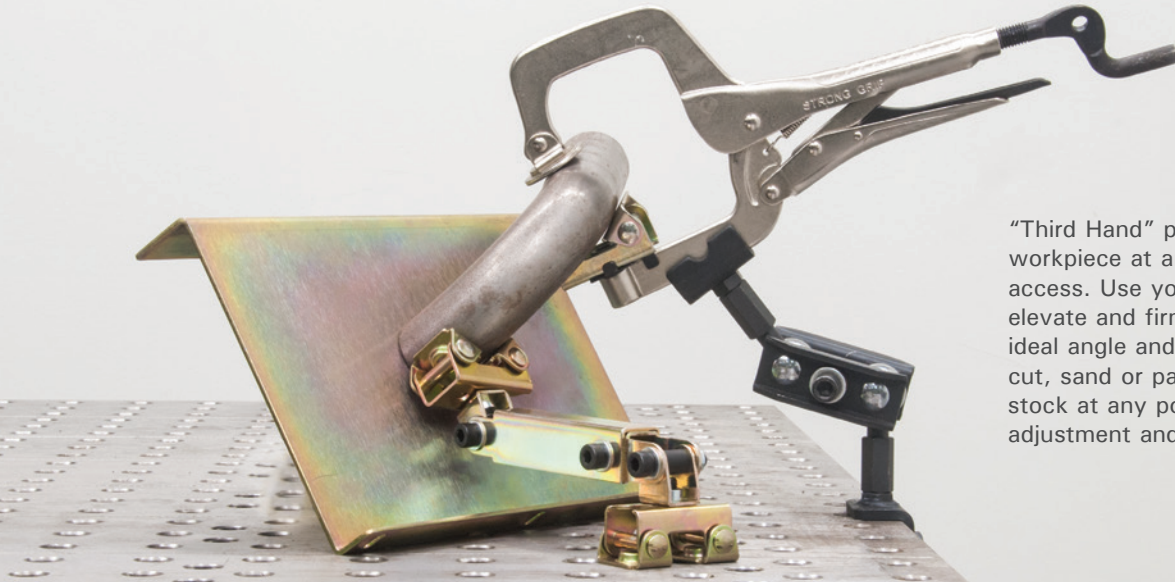

“Third Hand” positions your workpiece at any angle for full weld access. Use your THIRD HAND to elevate and firmly hold stock at the ideal angle and height while you weld, cut, sand or paint. Securely hold stock at any position with ball joint adjustment and locking.

Universal Clamp Base Model

HAS42

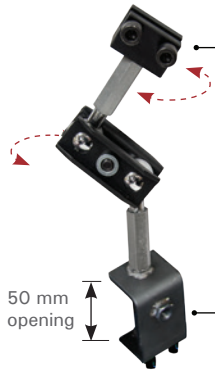

50 mm opening

Universal clamp base mounts on flat or square surfaces, angle iron, and 25 mm round posts.

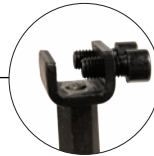

19 mm opening Slotted Adaptor Head accepts Pliers or Clamps to hold round, flat, square or angled stock. Two screws securely hold parts or clamps in position.

Welding Table Base Model

HAS40



Two links for applications requiring greater height or greater horizontal reach.

Two hole clamp base is compatible with Rhino Cart® and BuildPro® Welding Tables for mounting at any point on the tabletop.

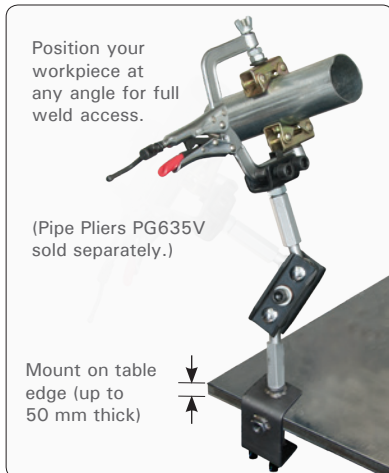

(Use with Big Mouth Pliers)

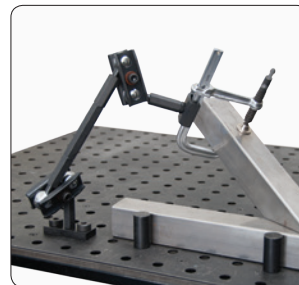

(Use with Utility Clamp UDV65M)



Hold sheet metal / plexiglass.

Part No.	Description	Weight (kg)
HAS42	Universal C-Clamp base model	1.1
HAS40	Welding table base model	1.6

Grasshoppers

Use the "third hand" to steady parts for tack welding! Safe and convenient!



NEW ITEM

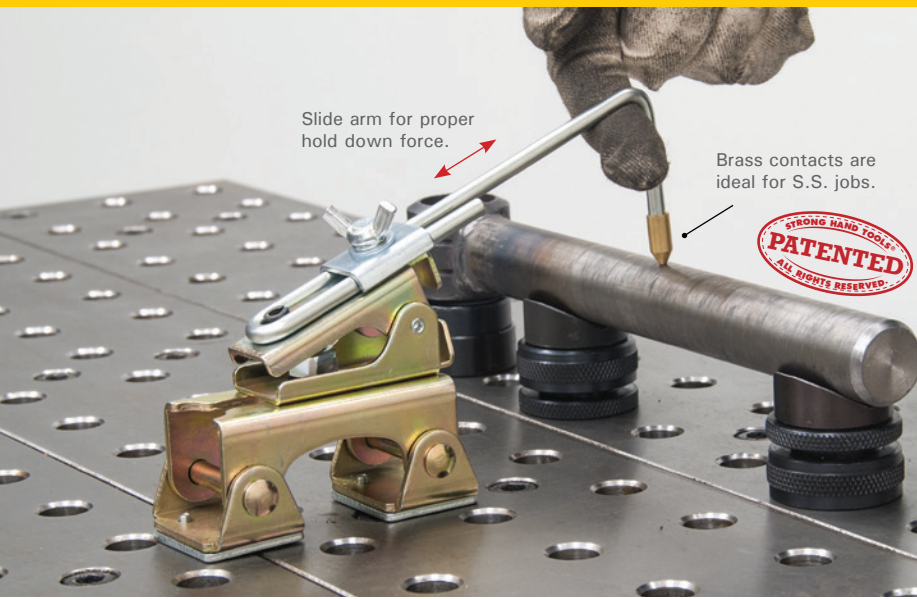

MAGNETIC GRASSHOPPERS

- Spring-loaded arm self-adjusts for **REPETITIOUS WORK HOLDING**.
- Pinpoint holding provides maximum clearance for tack welds.
- Adjustable V-Pad Base adapts to: round, square, flat, and angled surfaces.



Demo Video

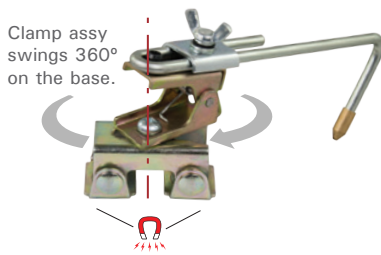
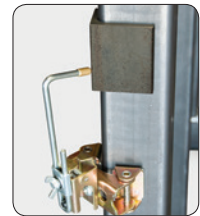

AGH200

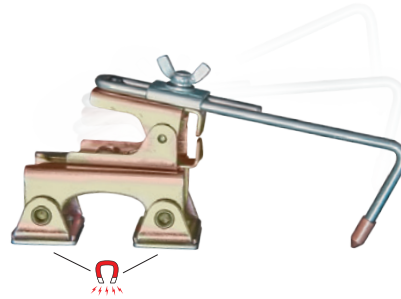

AGH230

Part No.	Product Includes	Length (mm)	Width x Height (mm)	Mag. Pull Force (kg)	Weight (kg)
AGH200	Adjustable Magnetic V-Pad Base, Brass Contact	190	64 x 88	8	0.2
AGH230	Adjustable Magnetic V-Pad Base, Brass Contact	203	100 x 100	15	0.5

STANDARD GRASSHOPPERS

Spring Clip to steady odd shaped parts or thin plates.

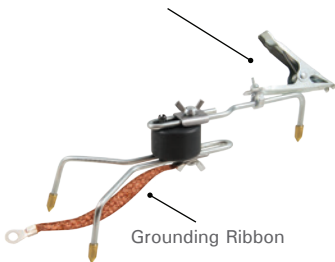

Pro Model - AGH130P



Arm and leg base are retractable for tight spot clamping and easy storage.

Econo Model - AGH130



Part No.	Product Includes	Length (mm)	Width x Height (mm)	Weight (kg)
AGH130P	Three Brass Contacts, Copper Ribbon, Spring Clip Attachment	200 ~ 300	114 x 102	0.7
AGH130	Brass Contact	200 ~ 300	114 x 102	0.7

2 and 3 Axis Fixture Vises Welders Angle Clamps

2-AXIS WELDERS ANGLE CLAMPS

Made with machined cast iron. Featuring these improvements:

- WAC35D and WAC45 have Machined outside faces - usable for upright joint
- Stand-off increases access
- Quick acting screw on deluxe models

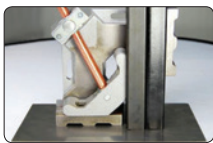
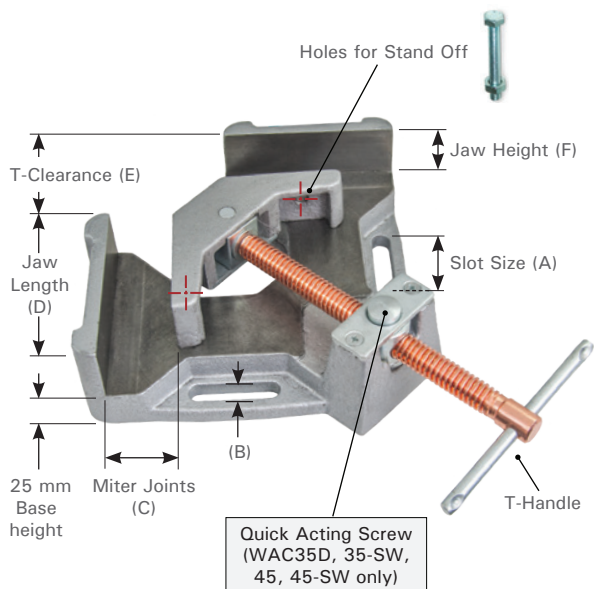

3-AXIS WELDERS ANGLE CLAMPS

Holds a 3-axis workpiece in position before welding.

Features the QUICK ACTING SCREWS and "SWING AWAY" Arm.

Hold parts in position during cool down to minimize distortion due to contraction.

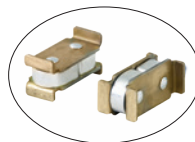
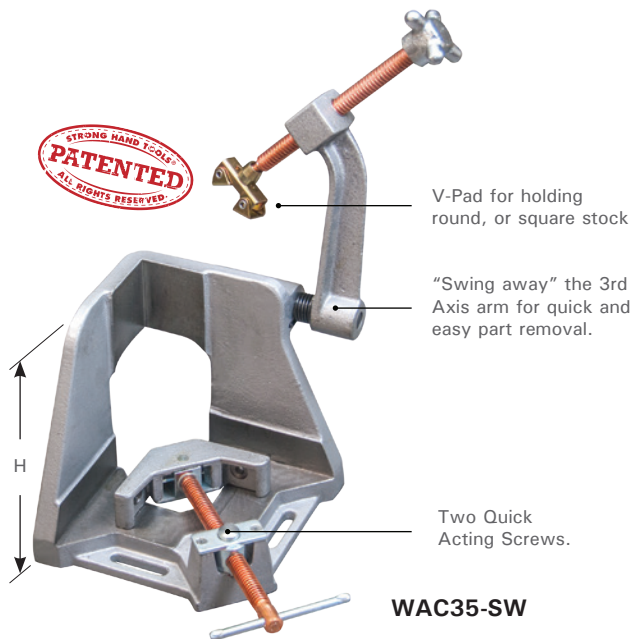

FREE with models:
WAC35D, WAC45, and
3-Axis Fixture Vises:
WAC35-SW, WAC45-SW.

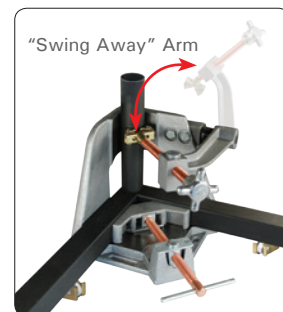

	Part No.	Features				A (mm)	B (mm)	C (mm)	D (mm)	E (mm)	F (mm)	H (mm)	Weight (kg)
		Quick Acting Screw	2x Stand-offs	2x Magnetic Rest Blocks	Swing Away Arm								
2-Axis	WAC22		✓			35.5	11	63.5	80	47	33	-	2.8
	WAC34		✓			40	11	95	107	64	35	-	4.3
	WAC35D	✓	✓	✓		40	11	95	107	64	35	-	4.5
	WAC45	✓	✓	✓		51	11	125	135	103	64	-	10
3-Axis	WAC35-SW	✓	✓	✓	✓	42	11	95	120	64	36	210	11
	WAC45-SW	✓	✓	✓	✓	51	11	125	135	103	64	245	16

90° Tru AngL & Portable MagVise™

Time saving aluminum vises for use in the shop and in the field.



ALUMINUM 90° TRU-ANGL JIG

- Accurate Right Angle Fixture.
- Weld spatter proof aluminum alloy.
- Holds round, square, flat and angled shapes.
- Works on both the outside and inside surfaces.
- Can be held in a vise.

Part No.	A (mm)	B (mm)	Jaw Height (mm)	Weight (kg)
LF-2	180	38	64	1.4

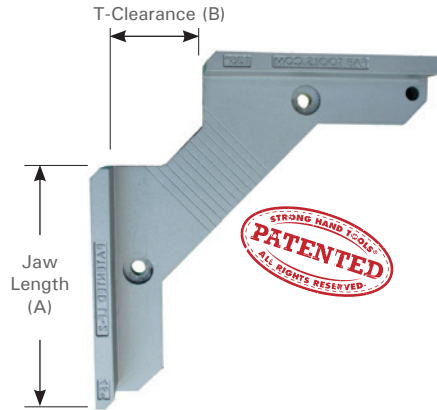

Held in vise



Used with pliers

PORTABLE MAGVISE™

Use the lightweight, compact Portable MagVise for quick 90° clamping in the shop, or in the field!

Magnets in the walls instantly hold pipes, tubes, angle iron, or metal plates in position for fast, accurate clamping at 90°.

Features the Quick-Acting Adjustable Spindle. Press and hold the Quick Acting Button and the spindle assembly slides in and out for a super fast set-up! Release the button and the threads re-engage for tightening.

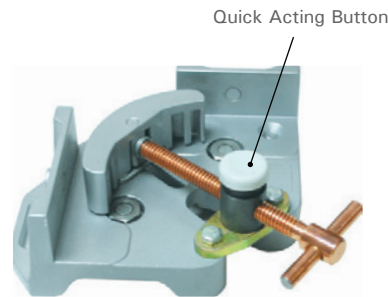

The rotatable spindle allows for holding work-pieces with different thicknesses.

Part No.	Features	Miter Joints (mm)	Jaw Length (mm)	T-Clearance (mm)	Jaw Height (mm)	Weight (kg)
WK50	MagVise™ with Adjustable Spindle	25	85	30	50	0.8

MAG-LEVEL

- The only magnetic level with the On/Off switch.
- Holds securely to round and flat surfaces.
- Three vials for 0°, 45°, 90° reading.

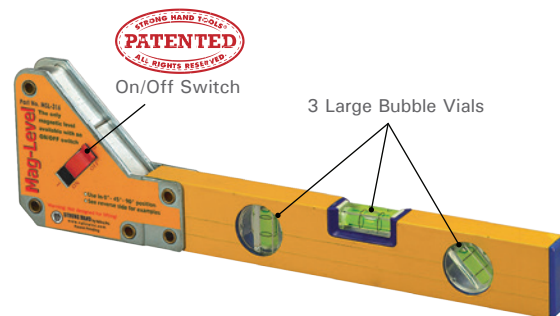
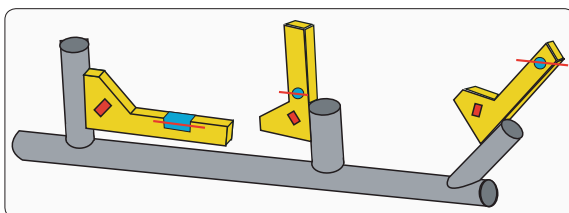

Part No.	Angles	Dimension (mm)	Max. Pull Force (kg)	Weight (kg)
MSL-316	45°, 90°, 180°	100 x 406 x 25	30	0.9

*Magnetic force is based on 10 mm thick steel.

PowerBase™ & Ground Hog™ Grounding Tools

High clamping pressure improves arc stability and reduces power consumption.

POWERBASE™ GROUNDING MAGNETS

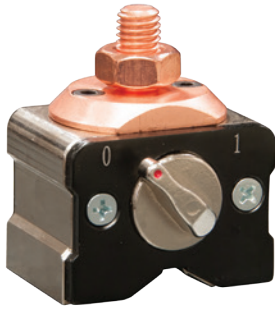

Turn OFF the PowerBase™ Grounding Magnet and metal chips fall away.

Power through your grounding applications! Start grounding instantly!

- The PowerBase™ Grounding Magnet sets up quickly and easily.
- Powerful rare earth magnet delivers heavy duty holding power.
- The “V” machined surface grips round parts.
- The copper connector stud allows for better conductivity.

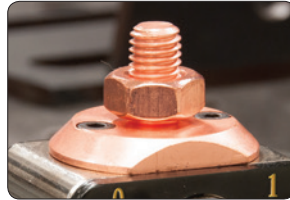

Large copper connector for better conductivity.

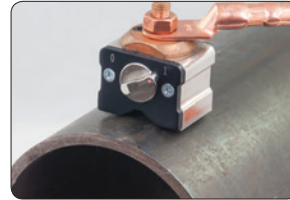

Holds securely onto round or flat surfaces.



The ON/OFF Lever is easy to turn, even while wearing gloves.

Part No.	Amperage	Dimension (mm)	Magnetic Force (kg)	Weight (kg)
GM203	300A @ 60% Duty Cycle	50 x 50 x 64	20	0.4
GM205	500A @ 60% Duty Cycle	50 x 70 x 64	50	1.1

GROUNDING CLAMP

Clamping + Grounding at the same time.

Consistently rated at 300 AMPS

Solid, insulated copper U-Channel rotates for easy access and can attach to round / odd-shaped parts.

GB428M

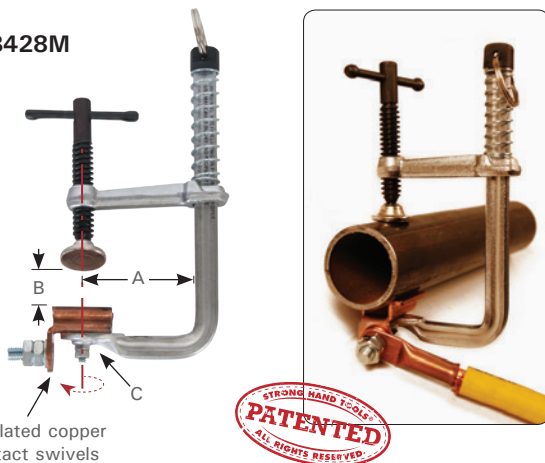

Insulated copper contact swivels

GROUND HOG™ CLAMP

Insulated Grounding Contact

The groove design on the copperhead seals out weld spatter and reduces particle buildup. Side screw provides a secure cable connection. Ground Hog body rotates for cable positioning.

- Controls the electrical current by isolating the contact surface and the cable connection.
- Improve arc stability and cable life, and reduce power consumption.

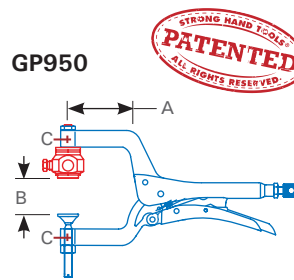

GP950



Ground Hog™

Rated at 450 AMPS @ 60% duty cycle (with 2/0 cable)

Part No.	Amperage / Cable Size	Throat Depth (A) (mm)	Max. Capacity (B) (mm)	Tapped Hole (C)	Clamping Pressure (kg)	OAL (mm)	Weight (kg)
GB428M	300A / --	64	75	M6	100	180	0.4
GP950	450A / 2/0 - 0.8	89	64	M10	180	280	1.1

Table Mount & Drill Press Clamps

Quick-set hold down clamps.

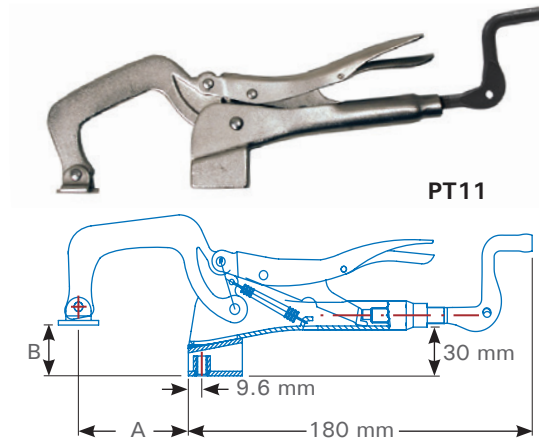

TABLE MOUNT LOCKING C-CLAMPS

Mounts directly to any work bench, drill press and fixtures.

- Mounting base hole accepts standard M8 bolts and uses push-down action to hold your workpiece securely.
- Use the Crank-Handle for pressure adjustment.
- Rapid lock and release. Ideal for repetitious clamping.

Part No.	Throat Depth (A) (mm)	Max. Capacity (B) (mm)	Mount Thread	Weight (kg)
PT11	86	100	M8	0.7
PT14	155	120	M8	0.9



DRILL PRESS CLAMP

Secure the Drill Press Clamp to any surface, up to 25 mm thick.

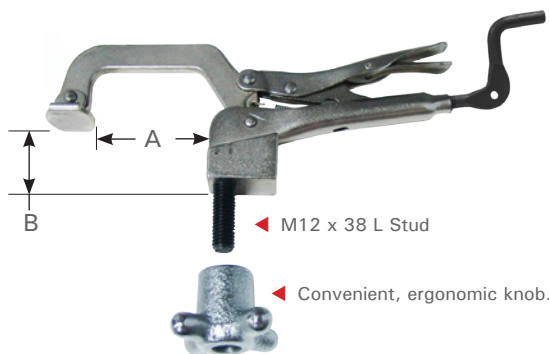

Part No.	A (mm)	B (mm)	Stud (mm)	Weight (kg)
PTD09	76	0 ~ 85	M12 x 38 L	0.9



CRANK HANDLE FOR ALL OUR PLIERS

Can be purchased separately. (See accessories page 40.)

Add the crank handle accessory to the clamps or pliers to:

- Adjust torque with the pliers in the locked position.
- Pre-set the Pliers opening for repetitious clamping applications.
- Loosen the Pliers before unlocking.



Part No.	Thread	For Pliers
PXCM6	M6	For 125 mm, 150 mm, 215 mm Pliers
PXCM8	M8	For 175 mm, 200 mm, 230 mm Pliers
PXCM10	M10	For 250 mm, 280 mm, 300 mm Pliers
PXCM12	M12	For 230 mm, 250 mm, 280 mm, 355 mm Pliers

Half Clamp & Hold Down Clamp

Hold down action clamps with unique features and accessories.

HALF CLAMP

The Efficient, Safe Way to Align Materials.

The DOG & WEDGE and CUT-OFF C-CLAMP methods of material alignment are messy, time consuming, and unsafe!

- Align materials in the fabrication of water tanks, bulkheads, deck sections, flat plates, etc.
- For big jobs, tack weld additional 48 mm cut pipes along the joint.

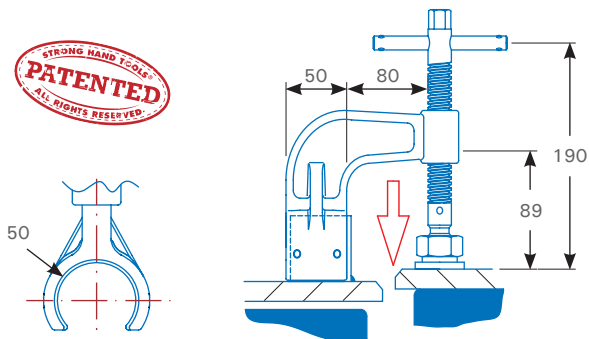

unit: mm



Part No.	Weight (kg)
VHC15	2.2

How to Use

Tack weld the front side of 48 mm pipe coupon to the lower of the two surfaces.

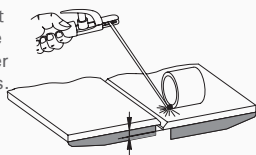

Slide Half Clamp onto the cut pipe, turn the handle until the misaligned materials align.

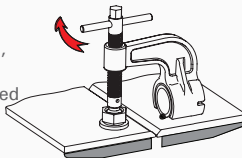

Use the rear slot on the Half Clamp to easily break off the coupon.

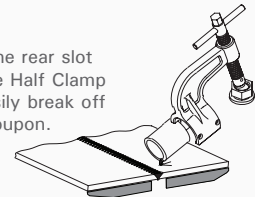

HOLD DOWN CLAMP

Bolt the clamp down to your worktable using the Ø10.5 mm hole in the base.

- The 12.5 mm copper plated Acme spindle resists weld spatter, and the swivel tip makes quick contact with your workpiece.
- Hold pipes by adding our Clip-On V-Pad, Part No. XDA2. (See page 41 for details.)



Copper Plated Acme Screw / Ductile Iron Body

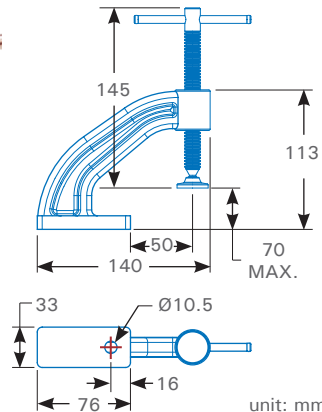

unit: mm

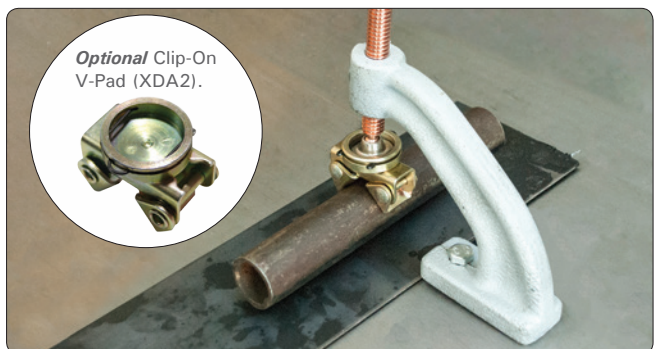

Part No.	Capacity (mm)	Weight (kg)
VHD30M	70	0.9

Side Clamp

Time saving tools for use in the shop & in the field.



SIDE CLAMP

Build push-action clamp to custom heights. Insert pipe (40 mm dia.) of desired length. Base can be bolt-mounted to the table.

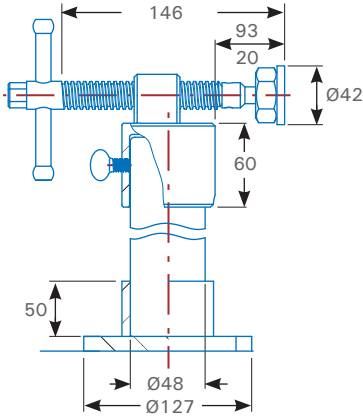

unit: mm

Part No.	Weight (kg)
VSC15	2.6

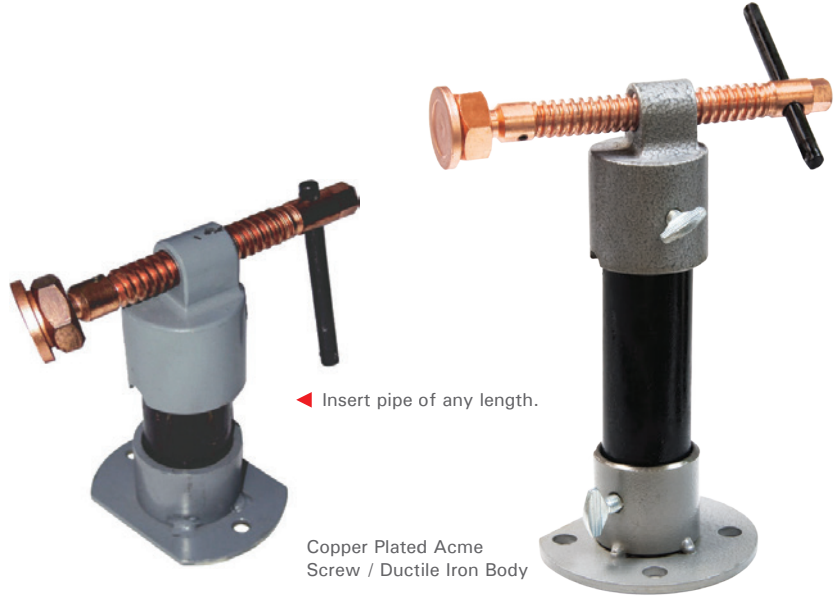

◀ Insert pipe of any length.

Copper Plated Acme Screw / Ductile Iron Body

Platen Clamps & Accessories

Platen and Universal Tabletop Clamps.

MODULAR PLATEN CLAMPS

For fast, secure clamping, simply insert the clamp into the 44.2 mm square hole in your acorn platen. Slide the clamp arm down to the work piece and turn the T-Handle to tighten.

- Choose from Acorn Bushing or Table Mount Models.
- Clamp comes with standard or heavy duty Swivel Pads.
- Unique *optional* Side-Kick Attachment provides push-action horizontal clamping force. (See accessories page 40)
- *Optional* V-Pads can be mounted on the Sliding Arm or Side-Kick Attachment. (See accessories page 40)

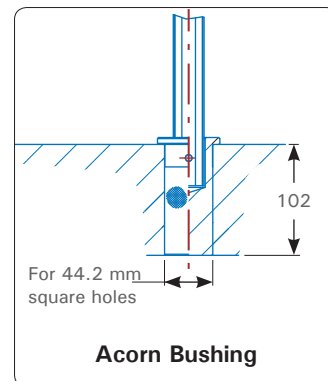
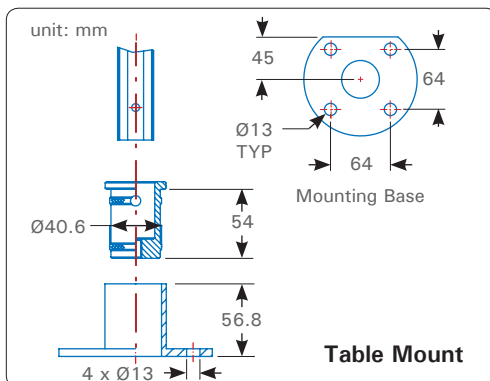
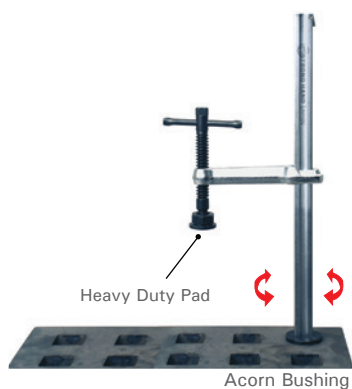

Table Mount

Part No.	Rail Size	Pad	Opening (mm)	Throat (mm)	Weight (kg)
UF8NC	"F"	Standard	203	120	2.2
UF10NC	"F"	Standard	254	120	2.2
UF12NC	"F"	Standard	305	120	2.4
UM12NC	"M"	HD	305	140	3.6
UM16NC	"M"	HD	406	140	4.0
UM20NC	"M"	HD	508	140	4.3

Acorn Bushing

Part No.	Rail Size	Pad	Opening (mm)	Throat (mm)	Weight (kg)
UF8NA	"F"	Standard	203	120	2.3
UF10NA	"F"	Standard	254	120	2.4
UF12NA	"F"	Standard	305	120	2.4
UM12NA	"M"	HD	305	140	3.6
UM16NA	"M"	HD	406	140	4.0
UM20NA	"M"	HD	508	140	4.4

SCREW-ON V-PAD

Attach to the top of Utility Clamps equipped with Heavy Duty Pads.
(See Page 41 for details.)

XMA



SLIDE-ON SIDEKICKS

Mount onto Clamps for 2-axis horizontal clamping.
(See Page 40 for details.)

XFSM / XGSM / XMSM



XDSM



NOMAD™ Economy Welding Table & Tool Kit

Very Affordable. Fully Adjustable. Easily Movable.



The Nomad Economy Welding Table is engineered to provide a safe, transportable, affordable, and versatile welding surface.

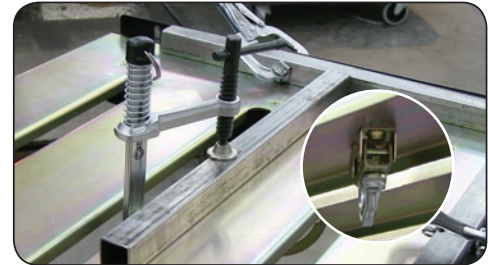
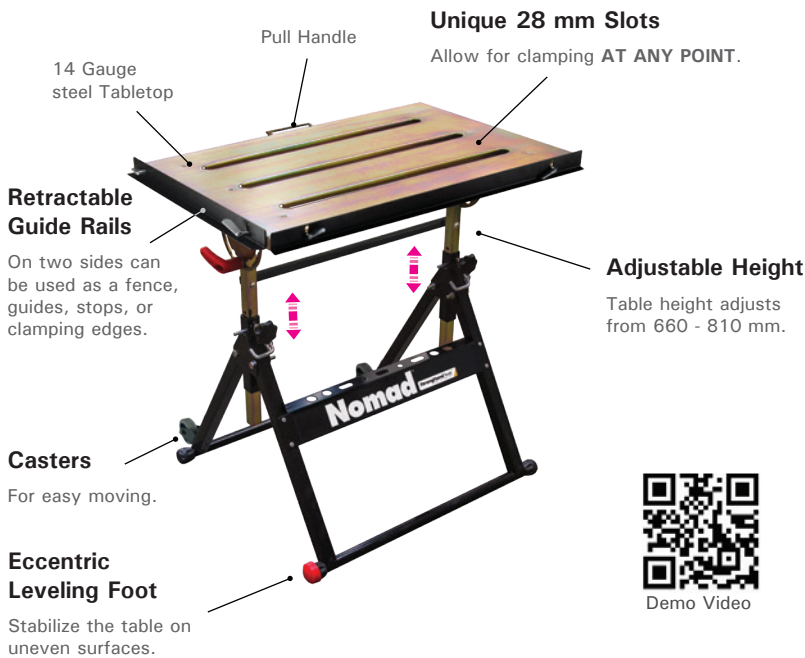

The MagSpring™ Clamps can be inserted into the 28 mm slots on the Nomad™ Tabletop for hold down clamping. Magnetic V-Pad jaw holds underneath the table to keep the clamp in the up-right, "ready to use" position.

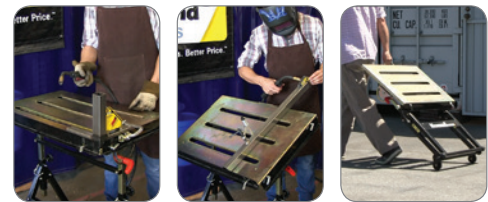

Flat

30°

Folded



Demo Video

Part No.	Tabletop Size (mm)	Table Height Range (mm)	Slot in Tabletop (mm)	Table Positions	Load Capacity (kg)	Weight (kg)
TS3020	760 W x 510 L	660 - 810	28	0°, 30°, Folded	160	20

The Nomad Economy Tool Kit is ideal for clamping and positioning stock on the Nomad Table.

Nomad™ Economy Tool Kit

Part No. TSK104M

MagSpring™ Clamps

- Spring loaded arm for fast opening.

Multi-Angle Magnet

- Hold stock at: 30°, 60°, 45°, 90°.

Mini Magnet

- Low profile for tight space holding.

Magnetic V-Pad

- Hold and elevate round, square, flat and angled stock.

2 MagSpring™ Clamps (UBV45M - 75 mm Cap.)

1 Multi-Angle Magnet (MS346C)

1 Mini Magnet (MS346A)

2 Adjustable Magnetic V-Pads (XDV4 - 4 magnets)

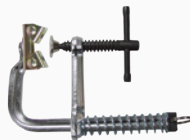

NOMAD™ CONNECTOR PLATE

Need more tabletop workspace? Use the Nomad™ Connector Plate to join two Nomad Tables together to create a 2.3 m long workstation!

Clamp and work on larger projects, or multiple projects with the fully adjustable work surface! There are thru holes on all four sides of the Connector Plate for multiple mounting options.



TSL30 (Includes all mounting screws)

Part No.	Weight (kg)
TSL30	7.4

Assembly Example

(All Products sold separately)

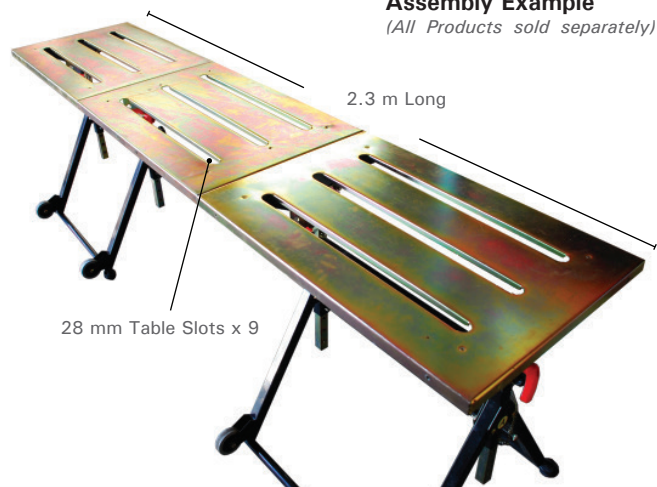



4-IN-1 PACKAGES (FOR U-CLAMPS)

Convert all Utility Clamps into 4-IN-1 Clamps. Includes a V-pad, an Extender Block, and a screw.

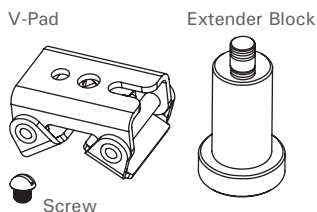

P/N	V-Pad	Extender Block	For Clamps
XDVB	XDV	XDB1M	UD Series
XFVB	XFV	XFVB	UE, UF, UG
XMVB	XMV	XMB2M	UM, UP Series
XPVB	XPV	XPB3M	UP Series

EXTENDER BLOCKS (FOR U-CLAMPS)

Attach to U-Clamps for Step-Over and Spreading applications.

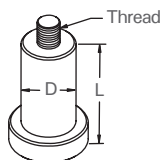

P/N	Thread	D	L	For Clamps
XDB1M	M8	16	25	UD Series
XFVB	M10	18	51	UE, UF, UG Series
XMB2M	M10	22	51	UM, UP Series
XPB3M	M10	28	75	UP Series

SIDEKICKS (FOR U-CLAMPS)

Mount onto U-Clamps for 2-axis horizontal clamping.

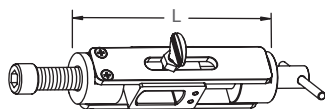

P/N	L	Stroke	For Clamps
XDSM	80	25	UD Series
XFSD	110	35	UF Series
XGSD	110	35	UG Series
XMSM	110	35	UM Series

U-CLAMPS REPLACEABLE PARTS

Replaceable Arm & Spindle Kits

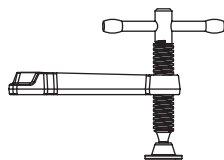

P/N	For U-Clamps Series
XDR	UD Series
XER	UE Series
XFR	UF Series
XGR	UG Series
XMR2	UM (Equipped with HD Pad)
XMRP2	UM (Equipped with Standard Pad)
XPR	UP Series

Individual Clamp Arms & Spindles

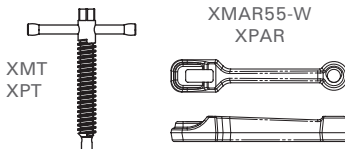

P/N	Description
XMT	Spindle for UM Series
XPT	Spindle for UP Series
XMAR55-W	Clamp Arm for UM Series
XPAR	Clamp Arm for UP Series

Spring Stop Replacement Kit

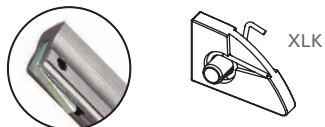

P/N	Description
XLK	For UE, UF, UG & UM Series clamps.

REPLACEABLE PADS

Heavy Duty Replacement joints and pads for UM & UP clamps.

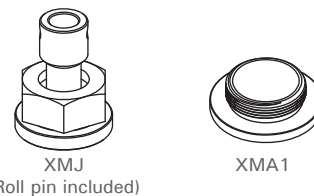

P/N	Description
XMJ	Joint & Pad Kit for UM & UP Clamps
XMA1	Replacement Pad only

Spring-loaded Standard Pads

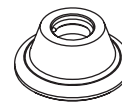

P/N	For U-Clamps Series
XDP	UB, UD Series
XFP	UE, UF, UG Series

PIPE ADAPTORS (FOR EXPAND-O)

Attach to Expand-O Pliers for wide spreading jobs and U-Clamps for Step-Over applications.

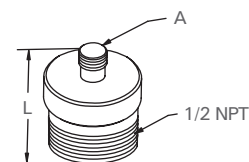

P/N	L	A	For Expand-O	For Clamps
XDJM	27	M8	PE6M	UD Series
XFJM	29	M10	PE10M	UE, UF, UG, UM, UP

PLIERS REPLACEMENT PARTS

Spring & Adjustment Bolt

Spring - 4 per set
PXS11
PXS6

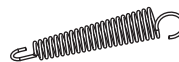

Adjustment Bolt

PXB11
PXB6



P/N	For Pliers
PXS11	280 mm Pliers
PXS6	150 mm & 215 mm Pliers
PXB11	280 mm Pliers
PXB6	150 mm & 215 mm Pliers

CRANK HANDLES (FOR PLIERS)

For all Strong Hand Tools® Pliers.

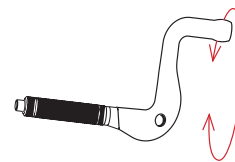

P/N	Thread	For Pliers
PXCM12	M12	230, 250, 280, 355 mm Pliers
PXCM10	M10	250, 280, 300 mm Pliers
PXCM8	M8	175, 200, 230 mm Pliers
PXCM6	M6	125, 150, 215 mm Pliers

Accessories

Accessories for Clamps and Pliers.

MAG. V-PADS (2 MAGNETS)

Rare earth magnetic V-Pads for holding round and angled pipes.

(Pad Face only):

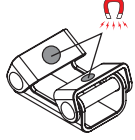

XDV2 / XFV2

(Bottom only):

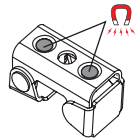

XDV3 / XFV3

P/N	Thru Hole	For Clamps	For Pliers
XDV2	M8	UD Series	PG622 / PG634
XDV3	M8	--	--
XFV2	M10	UE, UF, UG Series	PG114 / PG134M / PG204M / PGA20M
XFV3	M10	--	--

MAG. V-PADS (4 MAGNETS)

Rare earth magnetic V-Pads for holding round and angled pipes.

(Face & Bottom):

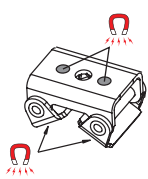

XDV4 / XFV4

(Pad Face only):

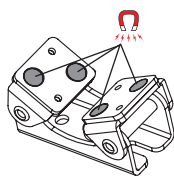

XNV2 / XNV210

P/N	Thru Hole	For Clamps	For Pliers
XDV4	M8	--	--
XFV4	M10	--	--
XNV2	M10	UM, UP Series	--
XNV210	M8	--	--

MAG. V-PADS W/ HANDLES

Hold and position steel stock at any angle in fixturing, welding, inspection and repair applications.

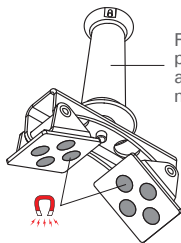

For control in placing, positioning and breaking the magnetic force.

P/N	Dimension	Thread
XPV830	121 x 51 x 158 mm	M8

STANDARD V-PADS

To hold round & angled workpieces.

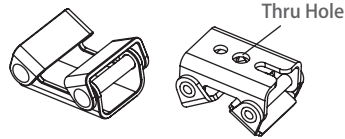

Thru Hole

P/N	Material	Thru Hole	For Clamps	For Pliers
XDV	Stainless Steel	M8	UD Series	PG622 / PG634
XFV	Stainless Steel	M10	UE, UF, UG Series	PG114 / PG134M / PG204M / PGA20M
XMV	Stainless Steel	M10	UM, UP Series	--
XPV	Stainless Steel	M10	UP Series	--
XDVS	Stainless Steel	M8	UD Series	PG622 / PG634
XFVS	Stainless Steel	M10	UE, UF, UG Series	PG114 / PG134M / PG204M / PGA20M
XMVS	Stainless Steel	M10	UM, UP Series	--

TOP V-PADS (FOR U-CLAMPS)

Attach to the top of Utility Clamps equipped with Standard Pads.

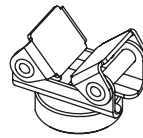

» For Light Duty & Value Series

P/N	Material	For U-Clamps Series
XDA2	Stainless Steel	UD Series
XFA2	Stainless Steel	UE, UF, UG Series
XMA2	Stainless Steel	UM, UP Series
XDA2S	Stainless Steel	UD Series
XFA2S	Stainless Steel	UE, UF, UG Series
XMA2S	Stainless Steel	UM, UP Series

Screw-On V-Pads

Attach to the top of Utility Clamps equipped with Heavy Duty Pads.

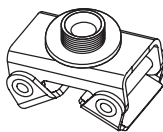

» For Regular and Heavy Duty Series

P/N	Material	For U-Clamps Series
XMA	Stainless Steel	UM, UP Series
XMAS	Stainless Steel	UM, UP Series

MAGNETIC TOP V-PADS

Add the magnetic top V-Pad onto the swivel pad to hold round, square, flat, and angled stock.

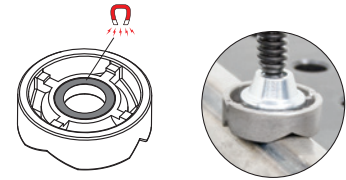

P/N	Material	For Clamps	For Pliers
T64217	Aluminum	UB, UD Series	PT07K
T64219	Aluminum	UE, UF Series	PT09K, PT11K, PT14K

T-STRAP BOLTS (FOR PLIERS)

For Step-Over applications.

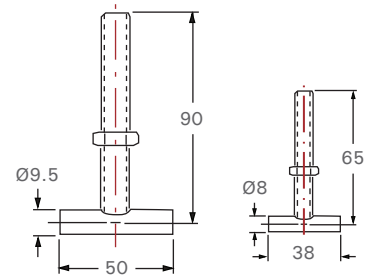

P/N	Thread	Length
840435M	M10	90
840335M	M8	65

SWIVEL / PIVOT PADS (FOR PLIERS)

Flat pads pivot at 150° and round pad swivels at 360°.

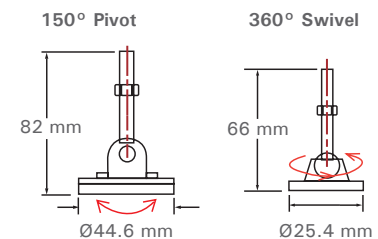

P/N	Thread	Height	Pad OD
854944M (Pivot)	M10	82 mm	Ø44.6 mm
854940M (Swivel)	M10	66 mm	Ø25.4 mm

Modular BuildPro® Tube & Pipe Notcher

Use the New Modular BuildPro® Tube & Pipe Notcher for the accurate fixturing of parts. www.BuildProTables.com

Mount your BuildPro® Tube & Pipe Notcher on the: BuildPro®, Rhino Cart®, or FixturePoint® Welding Tables or BuildPro® Fixturing Plates.

The 1st notch in a tube or pipe is easily completed with a drill press. The BuildPro® Tube & Pipe Notcher makes alignment and length control of the 2nd notch easy to complete accurately.

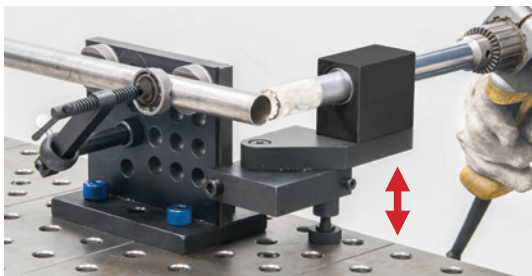
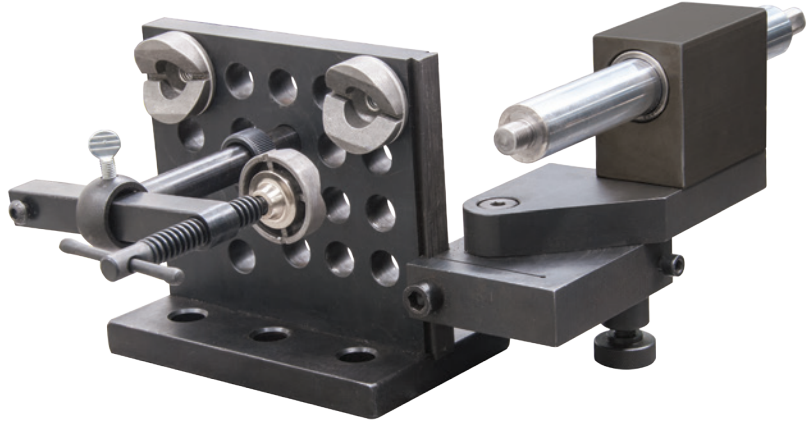

Notch 25 – 63.5 mm OD pipes or square tubes at any angle, or off-center. Position the two V-Blocks and clamp as needed.

In the examples below, the BuildPro® Tube & Pipe Notcher is used to notch workpieces as needed to fit seamlessly into a final assembly:

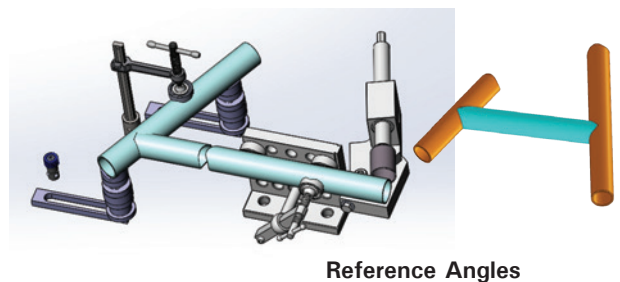
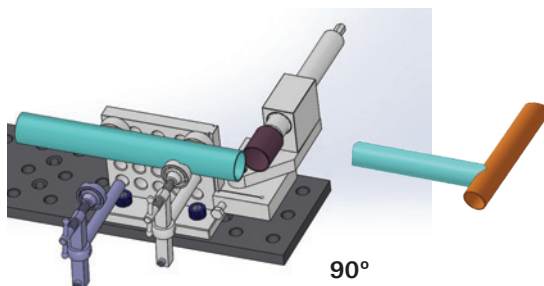
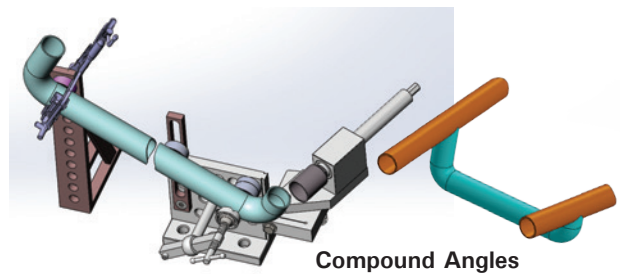
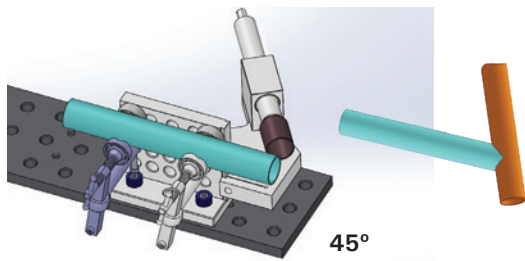



Toggle Clamps

Ideal time-saving jig and fixture clamps.
www.goodhandinc.com



Components

Standard Machine Parts & Tooling Components.
www.valtrainc.com

Vertical Handle
Hold Down Action

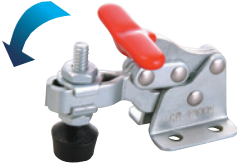

Horizontal Handle
Hold Down Action



Push/Pull
Straight Line Action

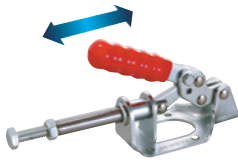

Latch Type
Pull Action



Cam Type
Hold Down Action

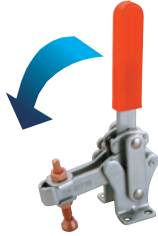

Toggle Pliers
Squeeze Action



F-Type
Pull Down Action

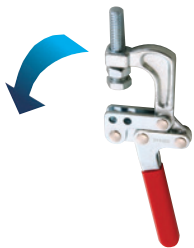

Pneumatic Power



Yoke Assemblies

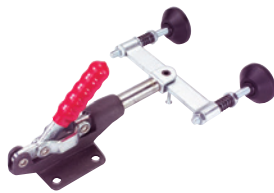

Heavy Duty Weldable
Hold Down Action



Bedding Supports



Cam Action Clamps



Forged Adjusta-Clamps



Adjustable Handles



Center Cam Clamps



Rotary T-Slot Nuts



Handwheels



Spring Stops



Handknobs



Cap Screw Hook Clamps



Speed Ball Handles



Lifting Eyebolts



Leveling Pads



Crank Handles



Heavy Duty Fixed Glides



Clamping Levers



T-Slot Bolts



Rotary T-Slot Bolts



Plain Eyebolts



T-Strap Bolts



Contact us for complete catalog.

BuildPro® Welding Tables

Faster Fixturing · Consistent Results · Greater Productivity

www.BuildProTables.com

The affordable, professional BuildPro® Welding Tables are setting a new standard in price and performance.

The BuildPro's modular design gives you the flexibility to adapt to each new project easily. You'll work more safely and efficiently, so you can increase both your productivity and quality of work.



Precision, ground steel plates, with CNC machined 16 mm holes in a 50 mm grid pattern for locating, positioning and holding your fixture with the BuildPro® clamps and components.

Plates can be reconfigured to extend the width of the table for larger projects.

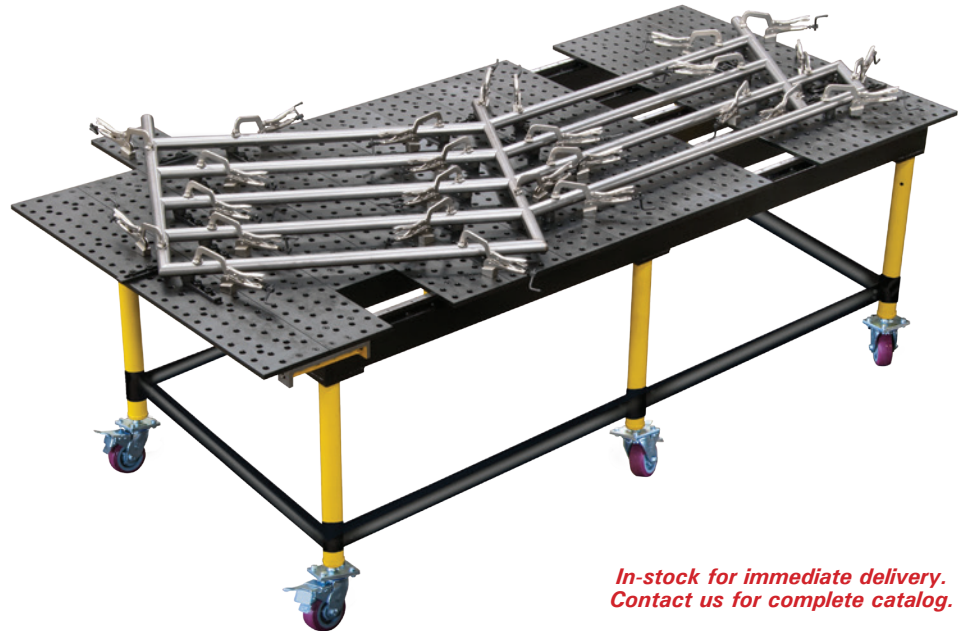

*In-stock for immediate delivery.
Contact us for complete catalog.*

Siegmund®

Heavy Duty Welding Tables and Clamping Systems.

www.siegmundtables.com



MADE IN GERMANY

CNC machined 28 mm dia. holes cover the five table faces in a 100 mm grid pattern for flexibility in the design and set-up of fixtures.

Visible grid lines on the tabletop help you align and position your workpiece for fixturing.

All Siegmund Welding Tables feature a *plasma nitride* finish for superior surface hardness, improved load capacity, long life, and protection against weld spatter and corrosion.

Siegmund Welding Tables feature a ONE PIECE, FIVE-FACE design with 25 mm thick reinforced steel plate for an extremely rigid and flat work surface.



*In-stock for immediate delivery.
Contact us for catalog.*

Rhino Cart®

Mobile Fixturing Station

www.rhino-cart.com



StrongHandTools®

RHINO CART™
MOBILE FIXTURING STATION

Charge right through your most challenging projects!

The **PATENTED** Rhino Cart® Mobile Fixturing Station is a turnkey system for fixturing and clamping in welding and fabrication. Clamp and fixture at any point on the reversible, flat, nitrided (heat treated) 1,200 x 750 mm tabletop for accuracy in all of your setups. Be ready to handle any job with the Rhino Cart® package, including: The Rhino Cart® Welding Table + 66 pc. Fixture Kit.



Table + Fixture Kit
ALL-IN-ONE
Mobility & Storage

(Kit content may differ from image.)

The Rhino Cart® Table is compatible with the Clamps and Components in the BuildPro® Welding Table product line.

FixturePoint® Jig & Fixture Tables

Affordable Modular Fixturing

www.StrongHandTools.com

The economy priced FixturePoint® Tables are ideal for the setup of 2D frames and other basic fixtures.

Choose from three clamp and component kits that mate to the 16 mm holes on the 900 x 600 mm tabletop.

The FixturePoint® tabletop can be detached from the leg frame for placement on alternate work surfaces as needed.



Tel: 562.949.8625
Fax: 562.949.4875
Email: sales@stronghandtools.com
Address: 8750 Pioneer Blvd.,
Santa Fe Springs, CA 90670, U.S.A.

©2018. All Rights Reserved.

