



MADE IN JAPAN



<http://www.shinanoinc.com/>



# CATALOG

2018 - 2019



## QUALITY JAPANESE AIR TOOLS

- IMPACT WRENCHES
- DRIVERS
- RATCHET WRENCHES
- SANDERS
- POLISHERS
- GRINDERS
- DRILLS/SPOTMILLS
- CUTTING TOOLS
- OTHERS



JQA-QMA13047



CM009



JQA-QMA13047



091

# MADE IN JAPAN



Shinano Inc was established in 1949, specialising in Pneumatic Tools from 1969. Building on our experience, we achieve excellent results in build quality, accuracy and user safety. With more than a hundred tools in the range, Shinano Inc is one of the worlds largest manufacturers of pneumatic tools.

## Sophisticated and Functional Design

Our tools are the result of over 45 years of pneumatic tool design. Our experience in research, engineering and production techniques, have created a line of high performance tools that are durable, reliable and easy to use.

## Perfection

Our customers needs are our top priority. Performance, quality, noise control and user safety, we stand by our products and strive for excellence.

This is our promise of the SI mark.

# Automotive Tools

# Industrial Tools



## The Green Project

Shinano contribute to environmental protection

### Solar power generation

The Solar power generation business was started from January, 2013 as an activity which utilizes renewable energy effectively for global environment protection

We are reducing the CO<sub>2</sub> in the same amount as the 20,000 trees in one year



Saitama Prefecture, SHINANO INC. Head quarters



Kagoshima Prefecture



Wakayama Prefecture



### ISO9001 Management system certificate



JQA-QMA13047



CM009



JQA-QMA13047



091

## IMPACT WRENCHES

P 5-10



### IMPACT WRENCHES

1/4" Impact Wrench	5	1/2" Impact Wrench	7	1/2" Impact Wrench	8	1" Impact Wrench	9
SI-1310S	6	SI-1457	7	SI-1460	8	SI-1555SR	9
3/8" Impact Wrench	6	SI-1610	7	SI-1460SR	8	SI-1860	9
SI-1315S	6	SI-1610SR	7	SI-1490	8	SI-1866	9
SI-1355	6	SI-1492	7	SI-1490BSR	8	SI-1870	9
SI-1365	6	SI-1492BSR	7	3/4" Impact Wrench	8	SI-1876	9
SI-1305	6	3/8" Impact Wrench	7	SI-1550	8	SI-1878	9
1/2" Impact Wrench	6	SI-1357	7	SI-1550SR	8	SI-1880	10
SI-1650AH	6	SI-1605	7	1-1/2" Impact Wrench	10	SI-1888	10
SI-1420T	6	SI-1605SR	7	SI-1900	10	EXPLANATION OF CLUTCH	10
SI-1422T	6	1/2" Impact Wrench	7				
		SI-1357	7				
		SI-1357	7				

## DRIVERS

P 11-13



### DRIVERS

Impact Driver	11
SI-1052	12
SI-1062	12
SI-1060	12
SI-1065	12
SI-1356D	12
SI-1365D	12
SI-1070	13
Screw Driver	13
SI-1170	13
SI-1140	13
SI-1161	13
SI-1166A	13
SI-1166-8A	13

## RATCHET WRENCHES

P 14-17



### RATCHET WRENCHES

1/4" Ratchet Wrench	14	1/2" Ratchet Wrench	16
SI-1107B	15	SI-1262	16
3/8" Ratchet Wrench	15	3/8" Ratchet Wrench	16
SI-1108B	15	SI-1320A	16
1/4" Ratchet Wrench	15	1/2" Ratchet Wrench	16
SI-1217EX	15	SI-1325A	16
3/8" Ratchet Wrench	15	3/8" Ratchet Wrench	17
SI-1218EX	15	SI-1241A	17
1/4" Ratchet Wrench	15	SI-1340EX	17
SI-1200B	15	1/2" Ratchet Wrench	17
3/8" Ratchet Wrench	15	SI-1345EX	17
SI-1205B	15	SI-1435	17
1/4" Ratchet Wrench	16	HEX 17mm Through	17
SI-1251	16	SI-1288	17
3/8" Ratchet Wrench	16		
SI-1252	16		
SI-1261	16		

## SANDERS

P 18-31



Central Vacuum Dual Action Sander	20	Dual Action Sander	22	ACCESSORIES	25-26
SI-3121-6	20	SI-3100/SI-3100M	22	Heavy Duty Mini Sander	27
Central Vacuum Dual Action Sander	20	Mini Dual Action Sander	22	SI-2008EX	27
SI-3121/SI-3121M	20	SI-3102M	22	Mini Sander	27
Dual Action Sander	20	SI-3112M	22	SI-2107A	27
SI-3101LG	20	Orbital Sander	23	Heavy Duty Mini Sander	27
SI-3101LGM	20	SI-3001A	23	SI-2108EX	27
Self Vacuum Dual Action Sander	20	SI-3001AM	23	SI-2108EX-2	27
SI-3111LG	20	Self Vacuum Orbital Sander	23	Disc Sander	28
SI-3111LGM	20	SI-3011A	23	SI-2210	28
Dual Action Sander	20	SI-3011AM	23	SI-2201	28
SI-3103B/SI-3103BM	20	Orbital Sander	23	SI-2201-2	28
Dual Action Sander	21	SI-3003A	23	SI-2202	28
SI-3103A/SI-3103AM	21	SI-3003AM	23	SI-2202-2	28
SI-3103-6A/SI-3103-6AM	21	Self Vacuum Orbital Sander	23	Mini Dual Action Sander	28
Self Vacuum Dual Action Sander	21	SI-3013	23	SI-2110S	28
SI-3113A/SI-3113AM	21	SI-3013M	23	Disc Sander	29
SI-3113-6A/SI-3113-6AM	21	Orbital Sander	24	SI-2300	29
Dual Action Sander	21	SI-3005	24	Oscillation Sander	29
SI-3101/SI-3101M	21	SI-3007/SI-3007M	24	SI-3200A	29
SI-3101-6/SI-3101-6M	21	Self Vacuum Orbital Sander	24	Wet Sander	29
Self Vacuum Dual Action Sander	21	SI-3018A	24	SI-2322WR-LE	29
SI-3111/SI-3111M	21	SI-3018AM	24	Mini Orbital Finishing Sander	30
SI-3111-6/SI-3111-6M	21	Orbital Sander	24	SI-3310	30
Self Vacuum Dual Action Sander	22	SI-3003B	24	ACCESSORIES	30
SI-3118A/SI-3118AM	22	SI-3003BM	24	SANDER LINEUP	31
SI-3118-6A/SI-3118-6AM	22	Disc Sander	24	Difference of Sanders	31
Self Vacuum Geared Dual Action Sander	22	SI-2026	24		
SI-3115R	22	SI-2351	24		
SI-2740	19				
SI-2741	19				
SI-2700	19				
SI-2700L	19				
SI-2700LS	19				
SI-2800	19				
SI-2830	19				

## POLISHERS

P 32-34



Geared Dual Action Polisher	32
SI-2415	33
Dual Action Polisher	33
SI-3100P	33
Single Action Polisher	33
SI-2221	33
SI-2224S	33
SI-2009EX	34
SI-2009H	34
SI-2400	34
Light Sander Polisher	34
SI-2405	34
Single Action Polisher	34
SI-2451	34
ACCESSORIES	34

## DRILLS / SPOT MILLS

P 41-45



SI-5305-8A	42
Drill	43
SI-5501	43
Reversible Drill	43
SI-5506	43
SI-5405	43
SI-5405-6	43
Angle Head Drill	43
SI-5355	43
Drill	43
SI-5500	43
SI-5505	43
Angle Head Drill	44
SI-5360	44
SI-5365	44
Spot Mill	44
SI-5800	44
SI-5850	44
ACCESSORIES	45

DRILLS / SPOT MILLS	41
Drill	42
SI-2015AD	42
SI-5100A	42
SI-5200A	42
SI-5300A	42
Reversible Drill	42
SI-5305A	42

## GRINDERS

P 35-40



GRINDERS	35	Die Grinder	36	Disc Grinder	38
SI-2001S	36	SI-2015A	36	SI-2501L	38
SI-2001S-6	36	SI-2015A-6	36	SI-2501	38
SI-2002EX	36	SI-2010	36	SI-2500L	38
SI-2002EX-6	36	SI-2010-6	36	SI-2500	38
SI-2011S	36	SI-2005HD	37	SI-2515LA	38
SI-2011S-6	36	SI-2005HD-6	37	SI-2505L	38
SI-2012EX	36	SI-2006S	37	Wet Grinder	39
SI-2012EX-6	36	SI-2006S-6	37	SI-2515WE	39
		Cut off Grinder	37	Disc Grinder	39
		SI-2033	37	SI-2600L	39
		Die Grinder	37	Micro Grinder	39
		SI-2022S	37	SI-2050AG	39
		SI-2022S-6	37	SI-2051SG	39
		SI-2023	37	GRINDER LINEUP	39
		SI-2023-6	37	ACCESSORIES	40

## CUTTING TOOLS

P 46-50



CUTTING TOOLS	46	Saw	47	Nibbler	49
SI-4700B	47	SI-4730	47	SI-4600	49
SI-4710	48	SI-4710F	48	Shear	49
SI-4740	48	SI-4740F	48	SI-4500	49
SI-4740F	48			Trimmer	49
				SI-2018A	49
				SI-2018A-6	49
				Oscillation Cutter	49
				SI-4300	49
				ACCESSORIES	50

## OTHERS

P 51-53



OTHERS	51	Air Hammer	52	Needle Scaler	53
SI-4120A	52	AIR HAMMER	52	SI-4160	53
ACCESSORIES	52	SI-4150EX	53	SI-4800	53
		Hydro Puncher	53		

## INDUSTRIAL TOOLS

P 54-68



DISC GRINDERS	57-62
STRAIGHT GRINDERS	63
DUAL ACTION SANDER	64
DIE GRINDERS	65-66
EDGE CUTTER	67-68

## ACCESSORIES

P 69-75

## SOUND & VIBRATION

P 76-78

## MAINTENANCE CHECK

P 79

## QUALITY

P 80

## Viewpoint of the catalogue page

Viewpoint of the product page

Model Number: **SI-1365** 3/8" Impact Wrench

Descriptions:
 

- The ultimate design for a 3/8" sq drive impact wrench
- Precision machined air motor for durability Muffled exhaust for industrial use

Impact Clutch: Double Hammer

Attachment Included: 458-58

Maximum Torque: 100Nm

Product image: SI-1365

Specification:
 

- Maximum Torque Nm/(ft-lb): 100/(74)
- Working Torque Range Nm/(ft-lb): 0-80/(0-59)
- Bolt Cap mm/(in.): 10/(3/8)
- Free Speed r.p.m.: 8,000
- Weight kg/(lb): 1.31/(2.89)
- Noise Level dBA/(power): 91/(102)
- Vibration a/k rms: 8.3/1.3
- Max Air Consumption CFM/(L/S): 19.8/(9.3)
- Avg Air Consumption CFM/(L/S): 3.3/(1.6)
- Air Inlet Size in.: 1/4
- Hose Size mm/(in.): 10/(3/8)

Figure of dimensions: Maximum Torque, Product image, Specification



SI-1490BSR

# IMPACT WRENCHES

- 1/4" IMPACT WRENCHES
- 3/8" IMPACT WRENCHES
- 1/2" IMPACT WRENCHES
- 3/4" IMPACT WRENCHES
- 1" IMPACT WRENCHES
- 1-1/2" IMPACT WRENCH

# IMPACT WRENCHES

1/2" Impact Wrenches · 1/4" Impact Wrench · 3/8" Impact Wrenches

### SI-1310S

1/4" Impact Wrench

- Composite body absorbs the vibration remarkably well and also protects your hand from the cold.
- Compact, lightweight, and a "feather touch" trigger for easy operation.
- Rear exhaust from handle-end directs air away from operator and workplace.

**Double Hammer**

Maximum Torque : **40Nm**

### SI-1315S

3/8" Impact Wrench

Maximum Torque : **60Nm**

### SI-1355

3/8" Impact Wrench

- Standard impact wrench with front exhaust
- Push button action for reverse

**Single Hammer**

Maximum Torque : **90Nm**

### SI-1365

3/8" Impact Wrench

- The ultimate design for a 3/8" sq drive impact wrench
- Precision machined air motor for durability Muffled exhaust for industrial use

**Double Hammer**

Maximum Torque : **100Nm**

### SI-1305

3/8" Impact Wrench

- 3/8"sq.palm grip Impact with butterfly throttle lever for quick and easy single hand operation
- 360° Air inlet swivel for easy manoeuvring

**Single Hammer**

Maximum Torque : **90Nm**

### SI-1650AH

1/2" Impact Wrench

- 90° head model
- Possible to turn the head 360°
- Ideal for changing the blade of tractors and farming equipment

**Twin Hammer**

Maximum Torque : **350Nm**

### SI-1420T

1/2" Impact Wrench

- Higher powered impact wrench with 1/2"sq. anvil
- The twin hammer clutch delivers higher torque and faster power delivery

**Twin Hammer**

Maximum Torque : **500Nm**

### SI-1422T

1/2" Impact Wrench with 2" Extended Anvil

- The same quality features of SI-1420T with 2" extended anvil

**Twin Hammer**

Maximum Torque : **480Nm**

	SI-1310S	SI-1315S
Maximum Torque Nm/(ft-lb)	40/(30)	60/(44)
Working Torque Range Nm/(ft-lb)	0-35/(0-26)	0-50/(0-37)
Bolt Cap mm/(in.)	8/(5/16)	10/(3/8)
Free Speed r.p.m.	10,000	10,000
Weight kg/(lb)	0.63/(1.39)	0.63/(1.39)
Noise Level dBA/(power)	86/(97)	86/(97)
Vibration a/k m/s <sup>2</sup>	4.8/0.9	4.9/1.0
Max Air Consumption CFM/(L/S)	12.6/(5.9)	12.6/(5.9)
Avg Air Consumption CFM/(L/S)	2.1/(1.0)	2.1/(1.0)
Air Inlet Size in.	1/4	1/4
Hose Size mm/(in.)	10/(3/8)	10/(3/8)

	SI-1355	SI-1365
Maximum Torque Nm/(ft-lb)	90/(66)	100/(74)
Working Torque Range Nm/(ft-lb)	0-75/(0-55)	0-80/(0-59)
Bolt Cap mm/(in.)	10/(3/8)	10/(3/8)
Free Speed r.p.m.	9,000	8,000
Weight kg/(lb)	1.12/(2.47)	1.31/(2.89)
Noise Level dBA/(power)	80/(91)	91/(102)
Vibration a/k m/s <sup>2</sup>	3.3/0.8	8.3/1.3
Max Air Consumption CFM/(L/S)	16.2/(7.6)	19.8/(9.3)
Avg Air Consumption CFM/(L/S)	2.7/(1.5)	3.3/(1.6)
Air Inlet Size in.	1/4	1/4
Hose Size mm/(in.)	10/(3/8)	10/(3/8)

	SI-1650AH
Maximum Torque Nm/(ft-lb)	350/(258)
Working Torque Range Nm/(ft-lb)	0-280/(0-207)
Bolt Cap mm/(in.)	16/(5/8)
Free Speed r.p.m.	(F)7,500 (R)8,000
Weight kg/(lb)	2.80/(6.17)
Noise Level dBA/(power)	91/(102)
Vibration a/k m/s <sup>2</sup>	18.1/2.2
Max Air Consumption CFM/(L/S)	24.0/(11.3)
Avg Air Consumption CFM/(L/S)	4.0/(1.9)
Air Inlet Size in.	1/4
Hose Size mm/(in.)	10/(3/8)

	SI-1420T	SI-1422T
Maximum Torque Nm/(ft-lb)	500/(369)	480/(354)
Working Torque Range Nm/(ft-lb)	0-400/(0-295)	0-360/(0-266)
Bolt Cap mm/(in.)	18/(11/16)	18/(11/16)
Free Speed r.p.m.	6,000	6,000
Weight kg/(lb)	2.55/(5.62)	2.65/(5.82)
Noise Level dBA/(power)	91/(102)	92/(103)
Vibration a/k m/s <sup>2</sup>	7.3/1.2	8.2/1.3
Max Air Consumption CFM/(L/S)	24.0/(11.3)	24.0/(11.3)
Avg Air Consumption CFM/(L/S)	4.0/(1.9)	4.0/(1.9)
Air Inlet Size in.	1/4	1/4
Hose Size mm/(in.)	10/(3/8)	10/(3/8)

IMPACT WRENCHES  
 DRIVERS  
 RATCHET WRENCHES  
 SANDERS  
 POLISHERS  
 GRINDERS  
 DRILLS  
 SPOTMILLS  
 CUTTING TOOLS  
 OTHERS  
 INDUSTRIAL TOOLS  
 SOUND & VIBRATION  
 MAINTENANCE CHECK  
 QUALITY

## SI-1357 3/8" Impact Wrench

- Ergonomic design, compact, and lightweight for easy operation.
- Easy to use in tight spaces.

**Twin Hammer**

Maximum Torque Nm/(ft-lb) 200/(147)

Working Torque Range Nm/(ft-lb) 0-160/(0-118)

Bolt Cap mm/(in.) 10/(3/8)

Free Speed r.p.m. (F)8,000 (R)9,000

Weight kg/(lb) 1.10/(2.43)

Noise Level dBA/(power) 92/(103)

Vibration a/k m/s<sup>2</sup> 7.6/1.2

Max Air Consumption CFM/(L/S) 21.6/(10.2)

Avg Air Consumption CFM/(L/S) 3.6/(1.7)

Air Inlet Size in. 1/4

Hose Size mm/(in.) 10/(3/8)

Maximum Torque : **200Nm**

Easy to operate feather touch trigger

Reverse lever

Rubber grip for reduced vibration and temperature stability

Regulator Dial

## SI-1457 1/2" Impact Wrench

- Ergonomic design, compact, and lightweight for easy operation.
- Easy to use in tight spaces.

**Twin Hammer**

Maximum Torque Nm/(ft-lb) 350/(258)

Working Torque Range Nm/(ft-lb) 0-280/(0-207)

Bolt Cap mm/(in.) 16/(5/8)

Free Speed r.p.m. (F)8,000 (R)9,000

Weight kg/(lb) 1.1/(2.43)

Noise Level dBA/(power) 92/(103)

Vibration a/k m/s<sup>2</sup> 9.1/1.4

Max Air Consumption CFM/(L/S) 21.6/(10.2)

Avg Air Consumption CFM/(L/S) 3.6/(1.7)

Air Inlet Size in. 1/4

Hose Size mm/(in.) 10/(3/8)

Maximum Torque : **350Nm**

Easy to operate feather touch trigger

Reverse lever

Rubber grip for reduced vibration and temperature stability

Regulator Dial

## SI-1460 1/2" Impact Wrench

**New**

- Extremely high breakaway torque of 1400Nm.
- It combines light weight and high power.
- Strong jumbo single hammer clutch.
- Composite motor housing for reduced vibration and temperature stability.

## SI-1460SR 1/2" Impact Wrench

**New**

**Breakaway Torque 1,400Nm**

**Only 1.57kg and 138mm length short size body.**

**Jumbo Single Hammer**

Maximum Torque : **850Nm**

Eight vanes Reach quickly max torque

Maximum Torque Nm/(ft-lb) 850/(627)

Working Torque Range Nm/(ft-lb) 0-620/(0-460)

Bolt Cap mm/(in.) 20/(3/4)

Free Speed r.p.m. (F)8,000 (R)8,500

Weight kg/(lb) 1.57/(3.46)

Noise Level dBA/(power) 88.3/(99.3)

Vibration a/k m/s<sup>2</sup> 9.5/1.4

Max Air Consumption CFM/(L/S) 30.6/(14.4)

Avg Air Consumption CFM/(L/S) 5.1/(2.4)

Air Inlet Size in. 1/4

Hose Size mm/(in.) 10/(3/8)

Easy to operate feather touch trigger

Rubber grip for reduced vibration and temperature stability

Handle grip exhaust directs air away from operator and work space

4 Position speed selector & Forward/Reverse selector

SR:Max Power Reverse Forward Adjustable 1~4 Reverse Maximum Power Only

## SI-1605/SI-1605SR 3/8" Impact Wrench

- Ergonomic design, compact, and lightweight for easy operation.
- Full power reverse helps to unfasten bolts quickly for changing wheels. (SI-1605SR)

**Twin Hammer**

Maximum Torque Nm/(ft-lb) 350/(258)

Working Torque Range Nm/(ft-lb) 0-280/(0-207)

Bolt Cap mm/(in.) 16/(5/8)

Free Speed r.p.m. (F)8,000 (R)8,500

Weight kg/(lb) 1.03/(2.27)

Noise Level dBA/(power) 94/(105)

Vibration a/k m/s<sup>2</sup> 8.6/1.3

Max Air Consumption CFM/(L/S) 22.8/(10.8)

Avg Air Consumption CFM/(L/S) 3.8/(1.8)

Air Inlet Size in. 1/4

Hose Size mm/(in.) 10/(3/8)

Maximum Torque : **350Nm**

Easy to operate feather touch trigger

Rubber grip for reduced vibration and temperature stability

Integrated muffler for reduced noise level

## SI-1610/SI-1610SR 1/2" Impact Wrench

- Ergonomic design, compact, and lightweight for easy operation.
- One hand forward & reverse operation.
- Full power reverse helps to unfasten bolts quickly for changing wheels. (SI-1610SR)

**Twin Hammer**

Maximum Torque Nm/(ft-lb) 450/(332)

Working Torque Range Nm/(ft-lb) 0-320/(0-258)

Bolt Cap mm/(in.) 18/(11/16)

Free Speed r.p.m. (F)8,000 (R)8,500

Weight kg/(lb) 1.04/(2.29)

Noise Level dBA/(power) 94/(105)

Vibration a/k m/s<sup>2</sup> 8.6/1.3

Max Air Consumption CFM/(L/S) 22.8/(10.8)

Avg Air Consumption CFM/(L/S) 3.8/(1.8)

Air Inlet Size in. 1/4

Hose Size mm/(in.) 10/(3/8)

Maximum Torque : **450Nm**

Easy to operate feather touch trigger

Rubber grip for reduced vibration and temperature stability

Integrated muffler for reduced noise level

## SI-1490B 1/2" Impact Wrench

- Light weight, high power and well balanced.
- 4 positions regulator dial for easy adjustment and it has a forward, reverse lever for easy adjustment.
- Integrated muffler for reduced noise level

## SI-1490BSR 1/2" Impact Wrench

**Twin Hammer**

Maximum Torque : **850Nm**

Eight vanes Reach quickly max torque

Maximum Torque Nm/(ft-lb) 850/(627)

Working Torque Range Nm/(ft-lb) 0-620/(0-457)

Bolt Cap mm/(in.) 20/(3/4)

Free Speed r.p.m. (F)8,000 (R)8,500

Weight kg/(lb) 1.9/(4.19)

Noise Level dBA/(power) 94/(105)

Vibration a/k m/s<sup>2</sup> 8.6/1.3

Max Air Consumption CFM/(L/S) 30.6/(14.4)

Avg Air Consumption CFM/(L/S) 5.1/(2.4)

Air Inlet Size in. 1/4

Hose Size mm/(in.) 10/(3/8)

Easy to operate feather touch trigger

Rubber grip for reduced vibration and temperature stability

Handle grip exhaust directs air away from operator and work space

4 Position speed selector & Forward/Reverse selector

SR:Max Power Reverse Forward Adjustable 1~4 Reverse Maximum Power Only

## SI-1492B/SI-1492BSR 1/2" Impact Wrench with 2" Extended Anvil

- The same quality features of SI-1490B & SI-1490BSR with 2" extended anvil

**Twin Hammer**

Maximum Torque Nm/(ft-lb) 830/(612)

Working Torque Range Nm/(ft-lb) 0-600/(0-443)

Bolt Cap mm/(in.) 20/(3/4)

Free Speed r.p.m. (F)8,000 (R)8,500

Weight kg/(lb) 1.94/(4.28)

Noise Level dBA/(power) 94/(105)

Vibration a/k m/s<sup>2</sup> 8.6/1.3

Max Air Consumption CFM/(L/S) 30.6/(14.4)

Avg Air Consumption CFM/(L/S) 5.1/(2.4)

Air Inlet Size in. 1/4

Hose Size mm/(in.) 10/(3/8)

Maximum Torque : **830Nm**

Easy to operate feather touch trigger

Rubber grip for reduced vibration and temperature stability

## SI-1556/SI-1556SR 3/4" Impact Wrench with 6" Extended Anvil

- SI-1550 & SI-1550SR with 6" extended anvil.
- 4 positions regulator dial for easy adjustment and it has a forward, reverse for easy adjustment.

**Twin Hammer**

Maximum Torque Nm/(ft-lb) 1,550/(1,143)

Working Torque Range Nm/(ft-lb) 0-1,240/(0-915)

Bolt Cap mm/(in.) 24/(15/16)

Free Speed r.p.m. (F)6,000 (R)6,500

Weight kg/(lb) 3.95/(8.71)

Noise Level dBA/(power) 93/(104)

Vibration a/k m/s<sup>2</sup> 11.1/1.5

Max Air Consumption CFM/(L/S) 48.0/(22.6)

Avg Air Consumption CFM/(L/S) 8.0/(3.8)

Air Inlet Size in. 3/8

Hose Size mm/(in.) 13/(1/2)

Maximum Torque : **1,550Nm**

Easy to operate feather touch trigger

Rubber grip for reduced vibration and temperature stability

Handle grip exhaust directs air away from operator and work space

## SI-1550 3/4" Impact Wrench

- Rubber grip absorbs the vibration remarkably well and also protects your hand from the cold.
- 4 positions regulator dial for easy adjustment and it has a forward, reverse for easy adjustment.

## SI-1550SR 3/4" Impact Wrench

**Twin Hammer**

Maximum Torque : **1,650Nm**

Maximum Torque Nm/(ft-lb) 1,650/(1,217)

Working Torque Range Nm/(ft-lb) 0-1,320/(0-974)

Bolt Cap mm/(in.) 24/(15/16)

Free Speed r.p.m. (F)6,000 (R)6,500

Weight kg/(lb) 3.25/(7.7)

Noise Level dBA/(power) 92/(103)

Vibration a/k m/s<sup>2</sup> 11.2/1.6

Max Air Consumption CFM/(L/S) 48.0/(22.6)

Avg Air Consumption CFM/(L/S) 8.0/(3.8)

Air Inlet Size in. 3/8

Hose Size mm/(in.) 13/(1/2)

Easy to operate feather touch trigger

Rubber grip for reduced vibration and temperature stability

Handle grip exhaust directs air away from operator and work space

4 Position speed selector & Forward/Reverse selector

SR:Max Power Reverse Forward Adjustable 1~4 Reverse Maximum Power Only

## SI-1555SR

1" Impact Wrench

- Pistol grip impact wrench with 1" sq. anvil.
- Rubber grip absorbs the vibration remarkably well and also protects your hand from the cold.
- 4 positions regulator dial for easy adjustment and it has an forward, reverse for easy adjustment.



Maximum Torque Nm/(ft-lb)	1,650/(1,217)
Working Torque Range Nm/(ft-lb)	0-1,320/(0-974)
Bolt Cap mm/(in.)	38/(1-1/4)
Free Speed r.p.m.	(F)6,000 (R)6,500
Weight kg/(lb)	3.5/(7.7)
Noise Level dBA/(power)	92/(103)
Vibration a/k m/s <sup>2</sup>	11.2/1.6
Max Air Consumption CFM/(L/S)	48.0/(22.6)
Avg. Air Consumption CFM/(L/S)	8.0/(3.8)
Air Inlet Size in.	3/8
Hose Size mm/(in.)	13/(1/2)

## SI-1860

1" Impact Wrench

- Pistol grip impact wrench with 1" sq. anvil.
- 3-piece body construction engineered for easy maintenance.
- Pinless Hammer Clutch for High Durability.



Maximum Torque Nm/(ft-lb)	2,500/(1,840)
Working Torque Range Nm/(ft-lb)	1,000-2,200/(740-1,620)
Bolt Cap mm/(in.)	41/(1-10/16)
Free Speed r.p.m.	4,700
Weight kg/(lb)	10.9/(24.0)
Noise Level dBA/(power)	94/(105)
Vibration a/k m/s <sup>2</sup>	8.8/1.3
Max Air Consumption CFM/(L/S)	82.7/(39.1)
Avg. Air Consumption CFM/(L/S)	13.8/(6.5)
Air Inlet Size in.	1/2
Hose Size mm/(in.)	13/(1/2)

## SI-1880

1" Impact Wrench

- Heavy Duty high power 1" impact wrench
- 3-piece body construction engineered for easy maintenance.
- Pinless Hammer Clutch for High Durability.
- Removable support handle can be rotated for left hand or right hand use.



Maximum Torque Nm/(ft-lb)	3,300/(2,430)
Working Torque Range Nm/(ft-lb)	900-2,800 (660-2,060)
Bolt Cap mm/(in.)	50 (1-15/16)
Free Speed r.p.m.	3,000
Weight kg/(lb)	15.4/(33.8)
Noise Level dBA/(power)	92/(103)
Vibration a/k m/s <sup>2</sup>	8.3/1.3
Max Air Consumption CFM/(L/S)	64.2/(30.3)
Avg. Air Consumption CFM/(L/S)	10.7/(5.0)
Air Inlet Size in.	1/2
Hose Size mm/(in.)	13(1/2)

## SI-1888

1" Impact Wrench with 8" Extended Anvil

- 8" extended anvil for easy reach into deep truck wheels.
- 3-piece body construction engineered for easy maintenance.
- Pinless Hammer Clutch for High Durability.
- Removable support handle can be rotated for left hand or right hand use.



Maximum Torque Nm/(ft-lb)	3,200/(2,360)
Working Torque Range Nm/(ft-lb)	800-2,700/(590-1,990)
Bolt Cap mm/(in.)	50/(1-15/16)
Free Speed r.p.m.	3,000
Weight kg/(lb)	17.1/(37.7)
Noise Level dBA/(power)	92/(103)
Vibration a/k m/s <sup>2</sup>	9.8/1.4
Max Air Consumption CFM/(L/S)	64.2/(30.3)
Avg. Air Consumption CFM/(L/S)	10.7/(5.0)
Air Inlet Size in.	1/2
Hose Size mm/(in.)	13/(1/2)

## SI-1870

1" Impact Wrench

- Straight body impact wrench with 1" sq. anvil and D handle.
- 3-piece body construction engineered for easy maintenance.
- Pinless Hammer Clutch for High Durability.
- Removable support handle can be rotated for left hand or right hand use.



Maximum Torque Nm/(ft-lb)	2,400/(1,770)
Working Torque Range Nm/(ft-lb)	880-2,100/(650-1,550)
Bolt Cap mm/(in.)	41/(1-10/16)
Free Speed r.p.m.	4,400
Weight kg/(lb)	10.6/(23.4)
Noise Level dBA/(power)	94/(105)
Vibration a/k m/s <sup>2</sup>	9.3/1.4
Max Air Consumption CFM/(L/S)	69.0/(32.5)
Avg. Air Consumption CFM/(L/S)	11.5/(5.4)
Air Inlet Size in.	1/2
Hose Size mm/(in.)	13/(1/2)

## SI-1866

1" Impact Wrench with 6" Extended Anvil

- 6" extended anvil for easy reach into deep truck wheels.
- 3-piece body construction engineered for easy maintenance.
- Pinless Hammer Clutch for High Durability.



Maximum Torque Nm/(ft-lb)	2,400/(1,770)
Working Torque Range Nm/(ft-lb)	900-2,100/(670-1,550)
Bolt Cap mm/(in.)	41/(1-10/16)
Free Speed r.p.m.	4,700
Weight kg/(lb)	12.4/(27.3)
Noise Level dBA/(power)	95/(106)
Vibration a/k m/s <sup>2</sup>	8.3/1.3
Max Air Consumption CFM/(L/S)	82.7/(39.1)
Avg. Air Consumption CFM/(L/S)	13.8/(6.5)
Air Inlet Size in.	1/2
Hose Size mm/(in.)	13/(1/2)

## SI-1900

1-1/2" Impact Wrench

- Heavy Duty impact wrench with 1-1/2" sq. anvil and D handle.
- 3-piece body construction engineered for easy maintenance.
- Removable support handle can be rotated for left hand or right hand use.



Maximum Torque Nm/(ft-lb)	5,500/(4,060)
Working Torque Range Nm/(ft-lb)	1,500-4,200/(1,110-3,100)
Bolt Cap mm/(in.)	55/(2-3/16)
Free Speed r.p.m.	3,600
Weight kg/(lb)	18.0/(39.7)
Noise Level dBA/(power)	107/(116)
Vibration m/s <sup>2</sup>	9.3
Max Air Consumption CFM/(L/S)	79.7/(37.6)
Avg. Air Consumption CFM/(L/S)	13.3/(6.3)
Air Inlet Size in.	1/2
Hose Size mm/(in.)	13/(1/2)

## SI-1876

1" Impact Wrench with 6" Extended Anvil

- 6" extended anvil for easy reach into deep truck wheels.
- Pinless Hammer Clutch for High Durability.

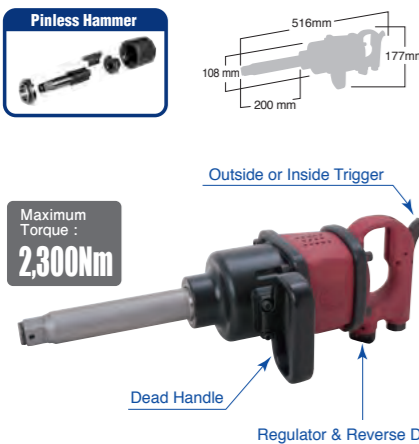

Maximum Torque Nm/(ft-lb)	2,300/(1,700)
Working Torque Range Nm/(ft-lb)	830-2,000/(610-1,470)
Bolt Cap mm/(in.)	40/(1-9/16)
Free Speed r.p.m.	4,400
Weight kg/(lb)	12.1/(26.7)
Noise Level dBA/(power)	94/(105)
Vibration a/k m/s <sup>2</sup>	12.1/1.7
Max Air Consumption CFM/(L/S)	69.0/(32.5)
Avg. Air Consumption CFM/(L/S)	11.5/(5.4)
Air Inlet Size in.	1/2
Hose Size mm/(in.)	13/(1/2)

## SI-1878

1" Impact Wrench with 8" Extended Anvil

- 8" extended anvil for easy reach into deep truck wheels.
- Pinless Hammer Clutch for High Durability.

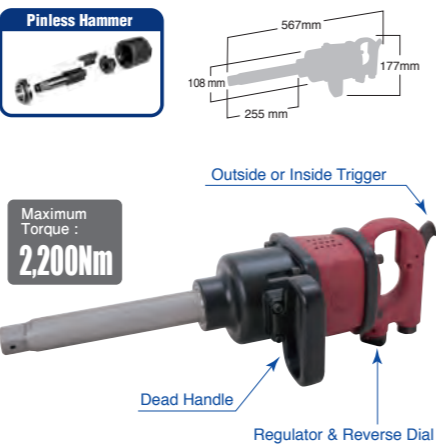

Maximum Torque Nm/(ft-lb)	2,200/(1,630)
Working Torque Range Nm/(ft-lb)	800-1,900/(590-1,400)
Bolt Cap mm/(in.)	40/(1-9/16)
Free Speed r.p.m.	4,400
Weight kg/(lb)	12.3/(27.1)
Noise Level dBA/(power)	94/(105)
Vibration a/k m/s <sup>2</sup>	11.1/1.5
Max Air Consumption CFM/(L/S)	69.0/(32.5)
Avg. Air Consumption CFM/(L/S)	11.5/(5.4)
Air Inlet Size in.	1/2
Hose Size mm/(in.)	13/(1/2)

## IMPACT CLUTCHES

### Jumbo Single Hammer

One hammer makes one impact per rotation.

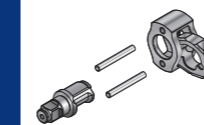

This design is most compact and light weight hammer configuration. It's similar to the Twin Hammer but with a single hammer. The clutch creates extremely high torque and durability.

### Single Hammer

Single hammer makes one impact per rotation.

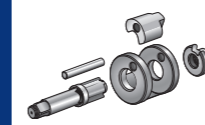

A single hammer is contained within the clutch rotor. This produces greater impact force per rotation and easy maintenance.

### Double Hammer

Two hammers makes two impacts per rotation.

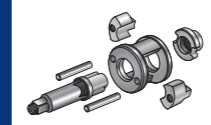

Twin hammers are contained within the clutch rotor. This design produces lower vibration levels and higher torque than a single hammer configuration.

### Twin Hammer

Two hammers make one impact per rotation.



This design is the most durable and light weight hammer configuration which produces less vibration, while maintaining high impact forces for its weight.

### Pin Clutch

One hammer makes one impact per rotation



Cam driven engaging pins that extend and retract once per rotation, engaging the anvil with the hammer to produce high force impacts. This configuration produces the highest torque delivery in the range with minimum vibration.

### Pinless Hammer

One hammer makes one impact per rotation



The impact power is transmitted directly to the anvil by a unified hammer and hammer pin. This unified hammer configuration delivers high impact force with long service life and easy maintenance.



SI-1170

# DRIVERS

IMPACT DRIVERS  
SCREW DRIVERS



## DRIVERS Impact Drivers

### SI-1052

Impact Driver

- 6mm capacity straight grip impact driver
- Have regulator built-in
- Compact body design for reduce weight and easy operation

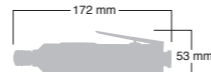
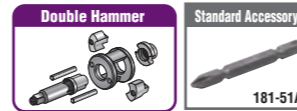

Shank Size in./ (mm)	1/4/(6.35)
Max Torque Nm/(ft-lb)	70/(51.6)
Working Torque Nm/(ft-lb)	0-60/(0-44)
Bolt Cap mm/(in.)	5/(3/16)
Free Speed r.p.m.	13,000
Weight kg/(lb)	0.56/(1.23)
Noise Level dBA/(power)	90/(101)
Vibration a/k m/s <sup>2</sup>	9.3/1.4
Max Air Consumption CFM/(L/S)	13.8/(6.5)
Avg Air Consumption CFM/(L/S)	2.3/(1.1)
Air Inlet Size in.	1/4

### SI-1062

Impact Driver

- More powerful than SI-1052
- Built-in regulator
- Compact body design for reduce weight and easy operation

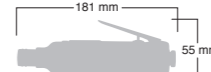
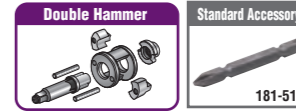

Shank Size in./ (mm)	1/4/(6.35)
Max Torque Nm/(ft-lb)	95/(70.1)
Working Torque Nm/(ft-lb)	0-70/(0-52)
Bolt Cap mm/(in.)	6/(1/4)
Free Speed r.p.m.	11,000
Weight kg/(lb)	0.79/(1.74)
Noise Level dBA/(power)	87/(98)
Vibration a/k m/s <sup>2</sup>	9.8/1.4
Max Air Consumption CFM/(L/S)	16.8/(7.9)
Avg Air Consumption CFM/(L/S)	2.8/(1.3)
Air Inlet Size in.	1/4

### SI-1060

Impact Driver

- 6mm capacity straight grip impact driver
- Compact, lightweight, ergonomic design for easy operation
- General use



Shank Size in./ (mm)	1/4/(6.35)
Max Torque Nm/(ft-lb)	65/(47.9)
Working Torque Nm/(ft-lb)	0-50/(0-37)
Bolt Cap mm/(in.)	6/(1/4)
Free Speed r.p.m.	11,000
Weight kg/(lb)	0.87/(1.92)
Noise Level dBA/(power)	89/(100)
Vibration a/k m/s <sup>2</sup>	10.8/2.8
Max Air Consumption CFM/(L/S)	17.4/(8.2)
Avg Air Consumption CFM/(L/S)	2.9/(1.4)
Air Inlet Size in.	1/4

### SI-1065

Impact Driver

- 6mm capacity pistol grip impact driver
- General use
- Ergonomic pistol grip for easy operation

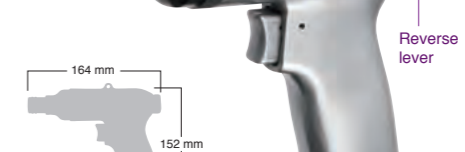

Shank Size in./ (mm)	1/4/(6.35)
Max Torque Nm/(ft-lb)	65/(47.9)
Working Torque Nm/(ft-lb)	0-45/(0-33)
Bolt Cap mm/(in.)	6/(1/4)
Free Speed r.p.m.	11,000
Weight kg/(lb)	0.98/(2.16)
Noise Level dBA/(power)	88/(99)
Vibration a/k m/s <sup>2</sup>	6.9/2.0
Max Air Consumption CFM/(L/S)	20.4/(9.6)
Avg Air Consumption CFM/(L/S)	3.4/(1.6)
Air Inlet Size in.	1/4

### SI-1356D

Impact Driver

- 8mm capacity pistol grip impact driver
- Double hammer mechanism

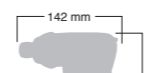
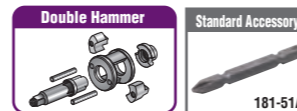

Shank Size in./ (mm)	1/4/(6.35)
Max Torque Nm/(ft-lb)	55/(40.6)
Working Torque Nm/(ft-lb)	0-45/(0-33)
Bolt Cap mm/(in.)	8/(5/16)
Free Speed r.p.m.	9,000
Weight kg/(lb)	1.22/(2.69)
Noise Level dBA/(power)	87/(98)
Vibration a/k m/s <sup>2</sup>	6.6/1.1
Max Air Consumption CFM/(L/S)	16.2/(7.6)
Avg Air Consumption CFM/(L/S)	2.7/(1.3)
Air Inlet Size in.	1/4

### SI-1365D

Impact Driver

- 8mm capacity pistol grip impact driver
- Industrial use

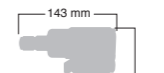

Shank Size in./ (mm)	1/4/(6.35)
Max Torque Nm/(ft-lb)	70/(51.6)
Working Torque Nm/(ft-lb)	0-60/(0-44)
Bolt Cap mm/(in.)	8/(5/16)
Free Speed r.p.m.	8,000
Weight kg/(lb)	1.32/(2.92)
Noise Level dBA/(power)	84/(95)
Vibration a/k m/s <sup>2</sup>	7.6/2.6
Max Air Consumption CFM/(L/S)	19.8/(9.3)
Avg Air Consumption CFM/(L/S)	3.3/(1.6)
Air Inlet Size in.	1/4

IMPACT WRENCHES  
DRIVERS  
RATCHET WRENCHES  
SANDERS  
PUSHERS  
GRINDERS  
DRILLS  
SPINDLES  
CUTTING TOOLS  
OTHERS  
INDUSTRIAL TOOLS  
SOUND & VIBRATION  
MAINTENANCE CHECK  
QUALITY

**SI-1070**

Impact Driver

- 6mm capacity pistol grip impact driver
- General use
- Compact, lightweight and a "feather touch" trigger for easy operation.

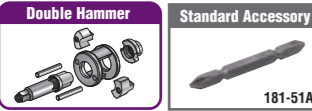

Reverse lever



Shank Size in./ (mm)	1/4/(6.35)
Max Torque Nm/(ft-lb)	35/(25.8)
Working Torque Nm/(ft-lb)	0-30/(0-22)
Bolt Cap mm/(in.)	6/(1/4)
Free Speed r.p.m.	11,000
Weight kg/(lb)	0.65/(1.43)
Noise Level dBA/(power)	83/(94)
Vibration a/k m/s <sup>2</sup>	6.4/2.1
Max Air Consumption CFM/(L/S)	12.6/(5.9)
Avg. Air Consumption CFM/(L/S)	2.1/(1.0)
Air Inlet Size in.	1/4

**SI-1170**

Screw Driver

- An adjustment ring with easy torque adjustment
- The full composite tool of an original design
- An oscillation is eased by a soft grip



Reverse lever



Shank Size in./ (mm)	1/4/(6.35)
Max Torque Nm/(ft-lb)	20/(14.8)
Working Torque Nm/(ft-lb)	4-11/(2.9-8.1)
Bolt Cap mm/(in.)	8/(5/16)
Free Speed r.p.m.	700
Weight kg/(lb)	0.85/(1.87)
Noise Level dBA/(power)	85/(96)
Vibration a/k m/s <sup>2</sup>	0.8/0.5
Max Air Consumption CFM/(L/S)	13.8/(6.5)
Avg. Air Consumption CFM/(L/S)	2.3/(1.1)
Air Inlet Size in.	1/4

**SI-1140**

Screw Driver

- 4mm capacity straight grip screw driver
- Clutch mechanism for easy adjustment of maximum torque

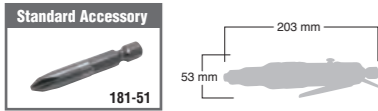

Reverse Button



Shank Size in./ (mm)	1/4/(6.35)
Max Torque Nm/(ft-lb)	1.5/(1.1)
Working Torque Nm/(ft-lb)	0.3-1.5/(0.2-1.1)
Bolt Cap mm/(in.)	4/(5/32)
Free Speed r.p.m.	1,700
Weight kg/(lb)	0.62/(1.36)
Noise Level dBA/(power)	80/(91)
Vibration a/k m/s <sup>2</sup>	0.2/0.5
Max Air Consumption CFM/(L/S)	11.4/(5.4)
Avg. Air Consumption CFM/(L/S)	1.9/(0.9)
Air Inlet Size in.	1/4

**SI-1161**

Screw Driver

- 6mm capacity straight grip screw driver
- Adjustable clutch
- Compact, lightweight, and ergonomic design for easy operation



Reverse Button



Shank Size in./ (mm)	1/4/(6.35)
Max Torque Nm/(ft-lb)	5.0/(3.7)
Working Torque Nm/(ft-lb)	1.5-5.0/(1.1-3.7)
Bolt Cap mm/(in.)	6/(1/4)
Free Speed r.p.m.	1,600
Weight kg/(lb)	1.12/(2.46)
Noise Level dBA/(power)	85/(96)
Vibration a/k m/s <sup>2</sup>	0.3/0.5
Max Air Consumption CFM/(L/S)	16.8/(7.9)
Avg. Air Consumption CFM/(L/S)	2.8/(1.3)
Air Inlet Size in.	1/4

**SI-1166A**

Screw Driver

- 6mm capacity pistol grip screw driver Adjustable clutch
- Ergonomic pistol grip for easy operation



Reverse lever



Shank Size in./ (mm)	1/4/(6.35)
Max Torque Nm/(ft-lb)	5.0/(3.7)
Working Torque Nm/(ft-lb)	1.5-5.0/(1.1-3.7)
Bolt Cap mm/(in.)	6/(1/4)
Free Speed r.p.m.	2,000
Weight kg/(lb)	1.18/(2.60)
Noise Level dBA/(power)	88/(99)
Vibration a/k m/s <sup>2</sup>	0.4/0.5
Max Air Consumption CFM/(L/S)	21.0/(9.9)
Avg. Air Consumption CFM/(L/S)	3.5/(1.6)
Air Inlet Size in.	1/4

**SI-1166-8A**

Screw Driver

- 8mm capacity pistol grip screw driver Adjustable clutch
- Ergonomic pistol grip for easy operation



Reverse lever



Shank Size in./ (mm)	1/4/(6.35)
Max Torque Nm/(ft-lb)	9.0/(6.6)
Working Torque Nm/(ft-lb)	1.5-9.0/(1.1-6.6)
Bolt Cap mm/(in.)	8/(5/16)
Free Speed r.p.m.	800
Weight kg/(lb)	1.35/(2.97)
Noise Level dBA/(power)	91/(102)
Vibration a/k m/s <sup>2</sup>	1.0/0.6
Max Air Consumption CFM/(L/S)	19.8/(9.3)
Avg. Air Consumption CFM/(L/S)	3.3/(1.6)
Air Inlet Size in.	1/4



SI-1218EX

**RATCHET WRENCHES**

- 1/4" RATCHET WRENCHES**
- 3/8" RATCHET WRENCHES**
- 1/2" RATCHET WRENCHES**
- HEX 17mm THROUGH RATCHET WRENCH**



# RATCHET WRENCHES

1/4" Ratchet Wrenches • 3/8" Ratchet Wrenches

## SI-1107B

1/4" Ratchet Wrench

- Super small ratchet wrench with 1/4"sq. anvil
- Smaller than SI-1200B & SI-1205B

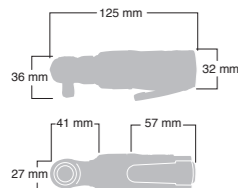

Shank Size in./ (mm)	1/4 / (6.35)
Maximum Torque Nm/ (ft-lb)	30/(22)
Working Torque Range Nm/ (ft-lb)	0-25/(0-18)
Bolt Cap mm/ (in.)	6.35/(1/4)
Free Speed r.p.m.	300
Weight kg/ (lb)	0.39/(0.86)
Noise Level dBA/ (power)	77/(88)
Vibration a/k m/s <sup>2</sup>	6.1/1.1
Max Air Consumption CFM/ (L/S)	10.8/(5.1)
Avg. Air Consumption CFM/ (L/S)	1.8/(0.8)
Air Inlet Size in.	1/8

## SI-1108B

3/8" Ratchet Wrench

- Super small ratchet wrench with 3/8"sq. anvil
- Smaller than SI-1200B & SI-1205B

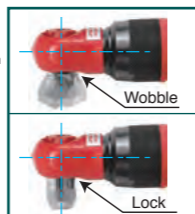
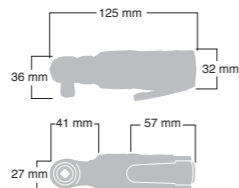

Shank Size in./ (mm)	3/8 / (9.5)
Maximum Torque Nm/ (ft-lb)	30/(22)
Working Torque Range Nm/ (ft-lb)	0-25/(0-18)
Bolt Cap mm/ (in.)	10/(3/8)
Free Speed r.p.m.	300
Weight kg/ (lb)	0.40/(0.88)
Noise Level dBA/ (power)	77/(88)
Vibration a/k m/s <sup>2</sup>	6.4/1.1
Max Air Consumption CFM/ (L/S)	10.8/(5.1)
Avg. Air Consumption CFM/ (L/S)	1.8/(0.8)
Air Inlet Size in.	1/8

## SI-1217EX

New

1/4" Ratchet Wrench

- The durable ratchet mechanism increased the lifetime by 30% than before
- Double mold composite body cover for added vibration and cold temperature protection.
- 360° air inlet swivel.

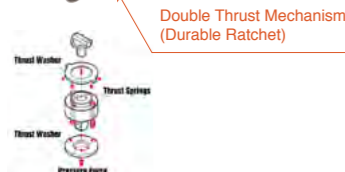

Shank Size in./ (mm)	1/4 / (6.35)
Maximum Torque Nm/ (ft-lb)	43/(31)
Working Torque Range Nm/ (ft-lb)	0-36/(0-26)
Bolt Cap mm/ (in.)	6.35/(1/4)
Free Speed r.p.m.	300
Weight kg/ (lb)	0.54/(1.18)
Noise Level dBA/ (power)	84/(95)
Vibration a/k m/s <sup>2</sup>	4.0/0.9
Max Air Consumption CFM/ (L/S)	9.6/(4.5)
Avg. Air Consumption CFM/ (L/S)	1.6/(0.8)
Air Inlet Size in.	1/4

## SI-1218EX

New

3/8" Ratchet Wrench

- The durable ratchet mechanism increased the lifetime by 30% than before
- Double mold composite body cover for added vibration and cold temperature protection.
- 360° air inlet swivel.

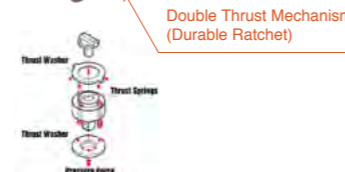

Shank Size in./ (mm)	3/8 / (9.5)
Maximum Torque Nm/ (ft-lb)	45/(35)
Working Torque Range Nm/ (ft-lb)	0-36/(0-25)
Bolt Cap mm/ (in.)	10/(3/8)
Free Speed r.p.m.	300
Weight kg/ (lb)	0.54/(1.20)
Noise Level dBA/ (power)	88/(99)
Vibration a/k m/s <sup>2</sup>	4.5/0.9
Max Air Consumption CFM/ (L/S)	9.6/(4.5)
Avg. Air Consumption CFM/ (L/S)	1.6/(0.8)
Air Inlet Size in.	1/4

## SI-1200B

1/4" Ratchet Wrench

- Light and small ratchet wrench with 1/4"sq. anvil
- This model is the "Mini Ratchet Wrench" standard in the air tools industry

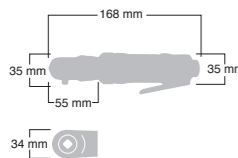

Shank Size in./ (mm)	1/4 / (6.35)
Maximum Torque Nm/ (ft-lb)	35/(26)
Working Torque Range Nm/ (ft-lb)	0-30/(0-22)
Bolt Cap mm/ (in.)	6.35/(1/4)
Free Speed r.p.m.	200
Weight kg/ (lb)	0.51/(1.11)
Noise Level dBA/ (power)	82/(93)
Vibration a/k m/s <sup>2</sup>	3.6/0.8
Max Air Consumption CFM/ (L/S)	9.6/(4.5)
Avg. Air Consumption CFM/ (L/S)	1.6/(0.8)
Air Inlet Size in.	1/4

## SI-1205B

3/8" Ratchet Wrench

- Light and small ratchet wrench with 3/8"sq. anvil
- This model is the "Mini Ratchet Wrench" standard in the air tools industry

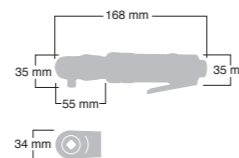

Shank Size in./ (mm)	3/8 / (9.5)
Maximum Torque Nm/ (ft-lb)	40/(30)
Working Torque Range Nm/ (ft-lb)	0-30/(0-22)
Bolt Cap mm/ (in.)	10/(3/8)
Free Speed r.p.m.	220
Weight kg/ (lb)	0.51/(1.12)
Noise Level dBA/ (power)	82/(93)
Vibration a/k m/s <sup>2</sup>	5.7/1.0
Max Air Consumption CFM/ (L/S)	9.6/(4.5)
Avg. Air Consumption CFM/ (L/S)	1.6/(0.8)
Air Inlet Size in.	1/4

# RATCHET WRENCHES

1/2" Ratchet Wrenches • 1/4" Ratchet Wrench • 3/8" Ratchet Wrenches

## SI-1251

1/4" Ratchet Wrench

- Japan and foreign patent(s) pending as the "Slide Switch" for the reverse function
- Plastic covered small size body
- 1/4"sq. anvil

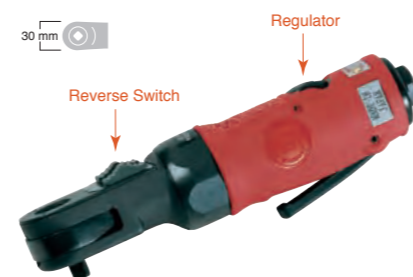
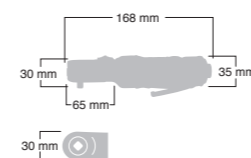

Shank Size in./ (mm)	1/4 / (6.35)
Maximum Torque Nm/ (ft-lb)	45/(33)
Working Torque Range Nm/ (ft-lb)	0-33/(0-24)
Bolt Cap mm/ (in.)	6.35/(1/4)
Free Speed r.p.m.	200
Weight kg/ (lb)	0.56/(1.24)
Noise Level dBA/ (power)	75/(86)
Vibration a/k m/s <sup>2</sup>	4.0/0.8
Max Air Consumption CFM/ (L/S)	14.4/(6.8)
Avg. Air Consumption CFM/ (L/S)	2.4/(1.1)
Air Inlet Size in.	1/4

## SI-1252

3/8" Ratchet Wrench

- Japan and foreign patent(s) pending as the "Slide Switch" for the reverse function
- Plastic covered small size body
- 3/8"sq. anvil

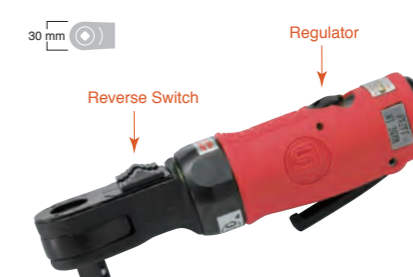
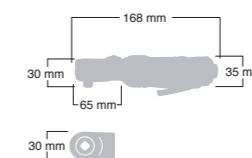

Shank Size in./ (mm)	3/8 / (9.5)
Maximum Torque Nm/ (ft-lb)	47/(35)
Working Torque Range Nm/ (ft-lb)	0-35/(0-26)
Bolt Cap mm/ (in.)	10/(3/8)
Free Speed r.p.m.	200
Weight kg/ (lb)	0.56/(1.24)
Noise Level dBA/ (power)	75/(86)
Vibration a/k m/s <sup>2</sup>	3.9/0.8
Max Air Consumption CFM/ (L/S)	14.4/(6.8)
Avg. Air Consumption CFM/ (L/S)	2.4/(1.1)
Air Inlet Size in.	1/4

## SI-1340EX

3/8" Ratchet Wrench

- Premium quality ratchet wrench with a rear exhaust and composite body cover.
- Low noise levels and precise planetary gear mechanism for maximum power transfer and durability.
- 360° air inlet swivel.



Shank Size in./ (mm)	3/8 / (9.5)
Maximum Torque Nm/ (ft-lb)	110/(81)
Working Torque Range Nm/ (ft-lb)	0-85/(0-63)
Bolt Cap mm/ (in.)	12/(1/2)
Free Speed r.p.m.	160
Weight kg/ (lb)	1.14/(2.50)
Noise Level dBA/ (power)	82/(93)
Vibration a/k m/s <sup>2</sup>	4.2/0.9
Max Air Consumption CFM/ (L/S)	15.0/(7.1)
Avg. Air Consumption CFM/ (L/S)	2.5/(1.2)
Air Inlet Size in.	1/4

## SI-1345EX

1/2" Ratchet Wrench

- Premium quality ratchet wrench with a rear exhaust and composite body cover.
- Low noise levels and precise planetary gear mechanism for maximum power transfer and durability.
- 360° air inlet swivel.

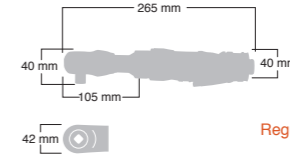

Shank Size in./ (mm)	1/2 / (12.7)
Maximum Torque Nm/ (ft-lb)	115/(85)
Working Torque Range Nm/ (ft-lb)	0-90/(0-66)
Bolt Cap mm/ (in.)	14/(9/16)
Free Speed r.p.m.	160
Weight kg/ (lb)	1.15/(2.53)
Noise Level dBA/ (power)	82/(93)
Vibration a/k m/s <sup>2</sup>	4.1/0.9
Max Air Consumption CFM/ (L/S)	15.0/(7.1)
Avg. Air Consumption CFM/ (L/S)	2.5/(1.2)
Air Inlet Size in.	1/4

## SI-1320A

3/8" Ratchet Wrench

- Standard ratchet wrench with the front exhaust 3/8"sq. anvil
- Reasonable price

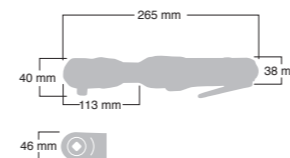

Shank Size in./ (mm)	3/8 / (9.5)
Maximum Torque Nm/ (ft-lb)	80/(59)
Working Torque Range Nm/ (ft-lb)	0-60/(0-44)
Bolt Cap mm/ (in.)	12/(1/2)
Free Speed r.p.m.	160
Weight kg/ (lb)	1.16/(2.57)
Noise Level dBA/ (power)	89/(100)
Vibration a/k m/s <sup>2</sup>	6.3/1.1
Max Air Consumption CFM/ (L/S)	16.2/(7.6)
Avg. Air Consumption CFM/ (L/S)	2.7/(1.3)
Air Inlet Size in.	1/4

## SI-1325A

1/2" Ratchet Wrench

- Standard ratchet wrench with the front exhaust
- 1/2"sq. anvil
- Best selling model in the world at a reasonable price

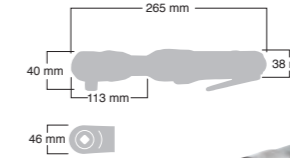

Shank Size in./ (mm)	1/2 / (12.7)
Maximum Torque Nm/ (ft-lb)	90/(66)
Working Torque Range Nm/ (ft-lb)	0-70/(0-52)
Bolt Cap mm/ (in.)	14/(9/16)
Free Speed r.p.m.	160
Weight kg/ (lb)	1.17/(2.58)
Noise Level dBA/ (power)	89/(100)
Vibration a/k m/s <sup>2</sup>	6.3/1.1
Max Air Consumption CFM/ (L/S)	15.0/(7.1)
Avg. Air Consumption CFM/ (L/S)	2.5/(1.3)
Air Inlet Size in.	1/4

# RATCHET WRENCHES

1/2" Ratchet Wrenches • 3/8" Ratchet Wrenches • HEX 17mm Through

## SI-1241A

3/8" Ratchet Wrench

- Swivel head with 9 levels
- An activity is possible at the locations which cannot work in the usual spanner and/or ratchet wrenches.
- The socket lock mechanism does not drop a socket on a narrow place.
- Japan and Foreign patent(s) pending as the "Quick release function" for easily releasing sockets

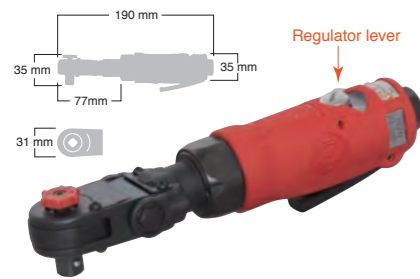

Shank Size in./ (mm)	3/8 / (9.5)
Maximum Torque Nm/ (ft-lb)	30/(22.1)
Working Torque Range Nm/ (ft-lb)	0-25/(0-18.4)
Bolt Cap mm/ (in.)	10/(3/8)
Free Speed r.p.m.	250
Weight kg/ (lb)	0.63/(1.38)
Noise Level dBA/ (power)	83/(94)
Vibration a/k m/s <sup>2</sup>	11.3/1.6
Max Air Consumption CFM/ (L/S)	11.4/(5.4)
Avg. Air Consumption CFM/ (L/S)	1.9/(0.9)
Air Inlet Size in.	1/4



Flexible head Quick release

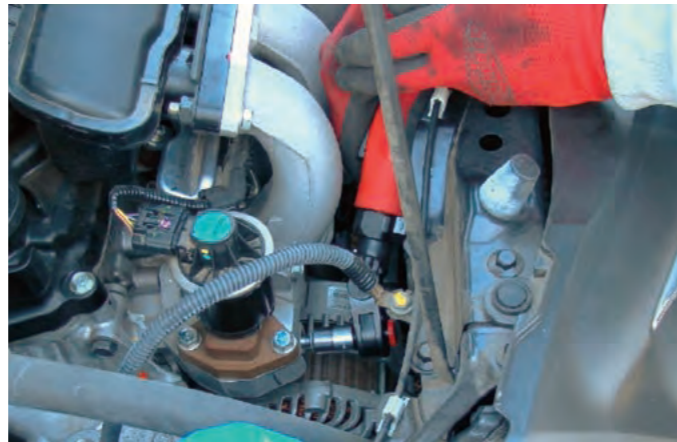

The flexible head can reach at tight spaces.

## SI-1261

3/8" Ratchet Wrench

- Japan and foreign patent(s) pending as the "Slide Switch" for the reverse function
- Plastic covered regular size body
- The lightest 960g in this class
- Lightweight and high strength super duralumin is used for housing

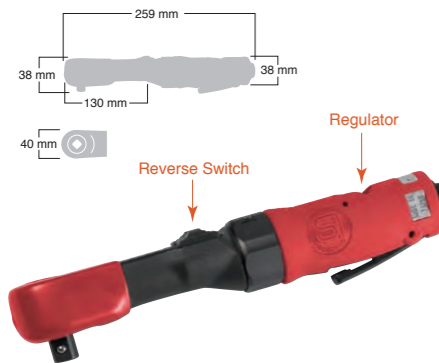

Shank Size in./ (mm)	3/8 / (9.5)
Maximum Torque Nm/ (ft-lb)	110/(81)
Working Torque Range Nm/ (ft-lb)	0-65/(0-48)
Bolt Cap mm/ (in.)	10/(3/8)
Free Speed r.p.m.	170
Weight kg/ (lb)	1.20/(2.65)
Noise Level dBA/ (power)	84/(95)
Vibration a/k m/s <sup>2</sup>	5.1/1.0
Max Air Consumption CFM/ (L/S)	18.0/(8.5)
Avg. Air Consumption CFM/ (L/S)	3.0/(1.4)
Air Inlet Size in.	1/4

## SI-1262

1/2" Ratchet Wrench

- Japan and foreign patent(s) pending as the "Slide Switch" for the reverse function
- Plastic covered regular size body
- The lightest 970g in this class we have ever had
- Lightweight and high strength super duralumin is used for housing

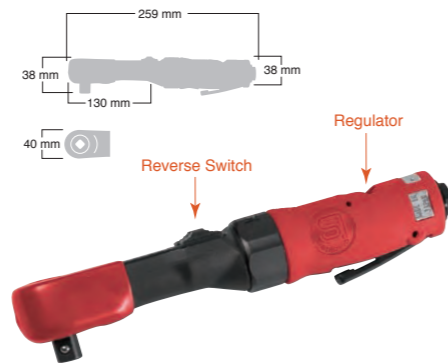

Shank Size in./ (mm)	1/2 / (12.7)
Maximum Torque Nm/ (ft-lb)	115/(85)
Working Torque Range Nm/ (ft-lb)	0-70/(0-52)
Bolt Cap mm/ (in.)	14/(9/16)
Free Speed r.p.m.	170
Weight kg/ (lb)	1.21/(2.67)
Noise Level dBA/ (power)	84/(95)
Vibration a/k m/s <sup>2</sup>	5.0/1.0
Max Air Consumption CFM/ (L/S)	18.0/(8.5)
Avg. Air Consumption CFM/ (L/S)	3.0/(1.4)
Air Inlet Size in.	1/4

## SI-1435

1/2" Ratchet Wrench

- The largest ratchet wrench in the range with the highest torque
- 1/2" sq. anvil
- Good for running nuts on tractor blades

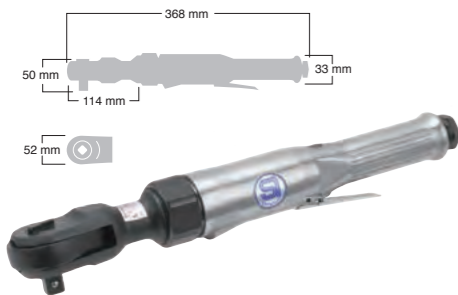

Shank Size in./ (mm)	1/2 / (12.7)
Maximum Torque Nm/ (ft-lb)	160/(118)
Working Torque Range Nm/ (ft-lb)	0-110/(0-81)
Bolt Cap mm/ (in.)	16/(5/8)
Free Speed r.p.m.	140
Weight kg/ (lb)	1.95/(4.31)
Noise Level dBA/ (power)	93/(104)
Vibration a/k m/s <sup>2</sup>	5.4/1.0
Max Air Consumption CFM/ (L/S)	28.2/(13.3)
Avg. Air Consumption CFM/ (L/S)	4.7/(2.2)
Air Inlet Size in.	1/4

## SI-1288

HEX 17mm Through

- Ratchet wrench with the unique interchangeable inner sockets
- Specially designed for using in small space
- Include 8mm, 10mm, 11mm, 12mm, 13mm and 14mm sockets

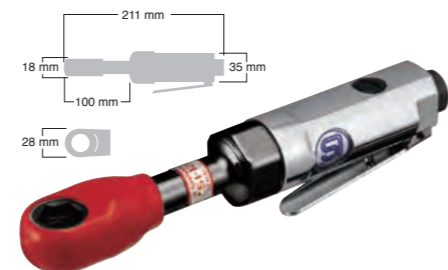

Shank Size in./ (mm)	HEX 17mm
Maximum Torque Nm/ (ft-lb)	45/(33)
Working Torque Range Nm/ (ft-lb)	0-35/(0-26)
Bolt Cap mm/ (in.)	8-17/(5/16-11/16)
Free Speed r.p.m.	180
Weight kg/ (lb)	0.54/(1.20)
Noise Level dBA/ (power)	84/(95)
Vibration a/k m/s <sup>2</sup>	6.8/1.1
Max Air Consumption CFM/ (L/S)	11.4/(5.4)
Avg. Air Consumption CFM/ (L/S)	1.9/(0.9)
Air Inlet Size in.	1/4



SI-3121-6

# SANDERS

- BELT SANDERS
- CENTRAL VACUUM DUAL ACTION SANDERS
- DUAL ACTION SANDERS
- SELF VACUUM DUAL ACTION SANDERS
- MINI DUAL ACTION SANDERS
- SELF VACUUM GEARED DUAL ACTION SANDERS
- MINI SELF VACUUM DUAL ACTION SANDERS
- ORBITAL SANDERS
- SELF VACUUM ORBITAL SANDERS
- DISC SANDERS
- MINI SANDER
- HEAVY DUTY MINI SANDERS
- OSCILLATION SANDER
- WET SANDER
- MINI ORBITAL FINISHING SANDER

## SI-2740

**10mm Belt Sander**

- 10mm sanding belt sander
- Super light & ergonomic design
- Rubber grip giving comfortable operation and reducing vibration

**OPTION**

509-45Z/40	10mm Sanding belt #40
509-45Z/80	10mm Sanding belt #80
509-45Z/100	10mm Sanding belt #100
509-45Z/120	10mm Sanding belt #120

**SI-2740**

**Standard Accessory**

509-45Z/60  
10mm Sanding belt #60x6

**Standard Accessory**

181-45

## SI-2741

**12mm Belt Sander**

- Adjustable 160° Sanding arm
- Light weight composite construction
- Includes air regulator for quick speed adjustment

**SI-2741**

**Standard Accessory**

509-60Z/12  
12mm Sanding belt #60x6

	SI-2740	SI-2741
Belt Size mm	10 x 330	12 x 330
Free Speed r.p.m.	15,000	15,000
Out Put Watt	317	317
Weight kg/(lb)	0.73/(1.61)	0.73/(1.61)
Noise Level dBA/(power)	85/(96)	85/(96)
Vibration a/k m/s <sup>2</sup>	1.0/0.6	1.0/0.6
Max Air Consumption CFM/(L/S)	19.8/(9.3)	19.8/(9.3)
Avg Air Consumption CFM/(L/S)	3.3/(1.6)	3.3/(1.6)

## SI-2700

**10mm Belt Sander**

- 10mm sanding belt sander
- Quick and easy belt change
- Adjustable arm angle

**OPTION**

509-45Z/40	10mm Sanding belt #40
509-45Z/80	10mm Sanding belt #80
509-45Z/100	10mm Sanding belt #100
509-45Z/120	10mm Sanding belt #120

**Standard Accessory**

509-45Z/60  
10mm Sanding belt #60x6

## SI-2700LS

**10mm Belt Sander**

- Adjustable 160° Sanding arm
- Quick change belt replacement lever

**Standard Accessory**

509-45Z/60  
10mm Sanding belt #60x6

	SI-2700	SI-2700LS
Belt Size mm	10x330	10x330
Free Speed r.p.m.	15,000	15,000
Out Put Watt	317	317
Weight kg/(lb)	0.82/(1.82)	0.82/(1.82)
Noise Level dBA/(power)	86/(99)	86/(99)
Vibration a/k m/s <sup>2</sup>	2.2/0.7	2.2/0.7
Max Air Consumption CFM/(L/S)	19.8/(9.3)	19.8/(9.3)
Avg Air Consumption CFM/(L/S)	3.3/(1.6)	3.3/(1.6)

## SI-2700L

**10mm Belt Sander**

- Head rotates 120 degrees for operating convenience. Variable speed throttle for positive control.
- Best for the light grinding, sanding and deburring. (SI-2700L)
- For nugget grinding of spot welding (SI-2700LS)

**SI-2700L**

**Standard Accessory**

509-130 10mm Felt belt #60 x 1  
509-131 10mm Felt belt #150 x 1  
509-132 10mm Felt belt #320 x 1

## SI-2700LS

**13mm Belt Sander**

- Adjustable 160° Sanding arm
- Quick change belt replacement lever

**Standard Accessory**

509LK-106  
13mm Sanding belt #60 x 5

	SI-2700L	SI-2700LS
Belt Size mm	10x460	13x460
Free Speed r.p.m.	15,000	15,000
Out Put Watt	317	317
Weight kg/(lb)	0.85/(1.87)	0.9/(1.98)
Noise Level dBA/(power)	83/(94)	84/(95)
Vibration a/k m/s <sup>2</sup>	2.5/0.7	1.6/0.6
Max Air Consumption CFM/(L/S)	19.8/(9.3)	19.8/(9.3)
Avg Air Consumption CFM/(L/S)	3.3/(1.6)	3.3/(1.6)

## SI-2800

**20mm Belt Sander**

- 20mm sanding belt sander
- Safety cover over belt wheel

**OPTION**

507-58Z/40	20mm Sanding belt #40
507-58Z/80	20mm Sanding belt #80
507-58Z/100	20mm Sanding belt #100
507-58Z/120	20mm Sanding belt #120

**Standard Accessory**

507-58Z/60  
20mm Sanding belt #60x6

## SI-2830

**30mm Belt Sander**

- 30mm sanding belt sander
- Safety cover over belt wheel
- Side handle for firm tool control

**OPTION**

505-56Z/40	30mm Sanding belt #40
505-56Z/80	30mm Sanding belt #80
505-56Z/100	30mm Sanding belt #100
505-56Z/120	30mm Sanding belt #120

**Standard Accessory**

505-56Z/60  
30mm Sanding belt #60x6

	SI-2800	SI-2830
Belt Size mm	20x520	30x540
Free Speed r.p.m.	15,000	10,000
Out Put Watt	429	582
Weight kg/(lb)	1.43/(3.14)	2.02/(4.45)
Noise Level dBA/(power)	84/(95)	86/(97)
Vibration a/k m/s <sup>2</sup>	3.0/0.8	1.6/0.6
Max Air Consumption CFM/(L/S)	22.8/(10.8)	31.8/(15.0)
Avg Air Consumption CFM/(L/S)	3.8/(1.8)	5.3/(2.5)

## SI-3121-6

**Central Vacuum Dual Action Sander with 6" pad**

- Central vacuum dual action sander for dust extraction system and vacuum cleaner
- Light weight and compact palm grip body
- 6" multihole pad giving speedy operation

**Standard Accessory**

6" Velcro  
M-150HDMH  
SI-3121-6

**Standard Accessory**

6" Face Cover  
1041CV-5  
SI-3121-6

**Standard Accessory**

6" Net paper #240x1 #120x1  
NP-150-240 NP-150-120  
SI-3121-6

## SI-3121

**SI-3121M: Velcro pad model**

**Central Vacuum Dual Action Sander with 5" pad**

- 6" Multihole pad
- Vacuum power adjuster

**Standard Accessory**

5" Velcro  
ME-125HD  
SI-3121M

**Standard Accessory**

5" Leather  
PE-125HD  
SI-3121

**Standard Accessory**

570-42A

	SI-3121-6	SI-3121/3121M
Pad/Disc Size mm/(in.)	150(6")	125(5")
Spindle Size	5/16-24UNF	5/16-24UNF
Orbit Dia mm	5	5
Free Speed r.p.m.	10,000	10,000
Out Put Watt	148	148
Weight kg/(lb)	1.31/(2.88)	1.29/(2.83)
Noise Level dBA/(power)	81/(92)	81/(92)
Vibration a/k m/s <sup>2</sup>	13.4/1.8	12.8/1.7
Max Air Consumption CFM/(L/S)	13.8/(6.5)	13.8/(6.5)
Avg Air Consumption CFM/(L/S)	2.3/(1.1)	2.3/(1.1)

## SI-3101LG

**Dual Action Sander with 5" leather pad**

- Low center of gravity dual action sander.
- The stable power can fully be delivered.
- Super light weight and easy to grip composite body cover.

**Standard Accessory**

5" Leather  
PE-125H  
SI-3101LG

## SI-3101LGM

**Dual Action Sander with 5" velcro pad**

- Low center of gravity design

**Standard Accessory**

5" Velcro  
ME-125H  
SI-3101LGM

	SI-3101LG	SI-3101LGM
Pad/Disc Size mm/(in.)	125(5")	125(5")
Spindle Size	5/16-24UNF	5/16-24UNF
Orbit Dia mm	5	5
Free Speed r.p.m.	10,000	10,000
Out Put Watt	148	148
Weight kg/(lb)	0.88/(1.94)	0.88/(1.94)
Noise Level dBA/(power)	88/(99)	88/(99)
Vibration a/k m/s <sup>2</sup>	13.7/1.8	13.7/1.8
Max Air Consumption CFM/(L/S)	13.2/(6.2)	13.2/(6.2)
Avg Air Consumption CFM/(L/S)	2.2/(1.0)	2.2/(1.0)

## SI-3111LG

**Self vacuum Dual Action Sander with 5" leather pad**

- Low center of gravity self vacuum dual action sander.
- The stable power can fully be delivered.
- Super light weight and easy to grip composite body cover.

**Standard Accessory**

5" Leather  
PE-125HD  
SI-3111LG

## SI-3111LGM

**Self vacuum Dual Action Sander with 5" velcro pad**

- Low center of gravity design

**Standard Accessory**

5" Velcro  
ME-125HD  
SI-3111LGM

**Standard Accessory**

1040-54  
485-42

	SI-3111LG	SI-3111LGM
Pad/Disc Size mm/(in.)	125(5")	125(5")
Spindle Size	5/16-24UNF	5/16-24UNF
Orbit Dia mm	5	5
Free Speed r.p.m.	10,000	10,000
Out Put Watt	148	148
Weight kg/(lb)	1.23/(2.71)	1.23/(2.71)
Noise Level dBA/(power)	88/(99)	88/(99)
Vibration a/k m/s <sup>2</sup>	13.7/1.8	13.7/1.8
Max Air Consumption CFM/(L/S)	13.8/(6.5)	13.8/(6.5)
Avg Air Consumption CFM/(L/S)	2.3/(1.1)	2.3/(1.1)

## SI-3103B

**SI-3103BM: Velcro pad model**

**Dual Action Sander with 5" pad**

- Heavy duty action sander for factory work.
- Powerful high quality air motor.
- Durable mechanism ensures a long working life.

**Standard Accessory**

5" Velcro  
M-125H  
SI-3103BM

**Standard Accessory**

5" Leather  
P-125H  
SI-3103B

## SI-3103B

**SI-3103BM: Velcro pad model**

**Dual Action Sander with 5" pad**

	SI-3103B	SI-3103BM
Pad/Disc Size mm/(in.)	125(5")	125(5")
Spindle Size	5/16-24UNF	5/16-24UNF
Orbit Dia mm	5	5
Free Speed r.p.m.	9,000	9,000
Out Put Watt	134	134
Weight kg/(lb)	1.18/(2.60)	1.18/(2.60)
Noise Level dBA/(power)	87/(98)	87/(98)
Vibration a/k m/s <sup>2</sup>	15.6/2.0	15.6/2.0
Max Air Consumption CFM/(L/S)	16.8/(7.9)	16.8/(7.9)
Avg Air Consumption CFM/(L/S)	2.8/(1.3)	2.8/(1.3)

## SI-3103A

SI-3103AM : Velcro pad model

Dual Action Sander with 5" pad

## SI-3103-6A

SI-3103-6AM : Velcro pad model

Dual Action Sander with 6" pad

SI-3103A/3103AM SI-3103-6A/3103-6AM

- Standard dual action sander with palm grip 5" pad are available (SI-3103A)
- Powerful, high quality air motor
- 5mm orbit diameter Suitable for both rough and finish sanding
- The same quality features of SI-3103 with 6" pad model (SI-3103-6A)

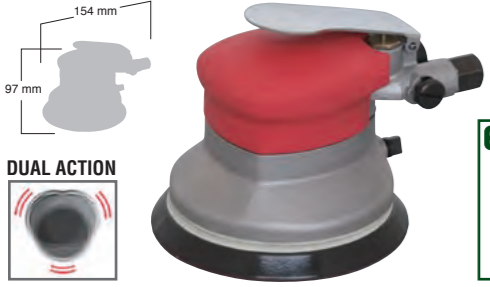

Pad/Disc Size mm/(in.)	125/(5")	150/(6")
Spindle Size	5/16-24UNF	5/16-24UNF
Orbit Dia mm	5	5
Free Speed r.p.m.	9,000	9,000
Out Put Watt	134	134
Weight kg/(lb)	1.18/(2.60)	1.20/(2.64)
Noise Level dBA/(power)	80/(91)	80/(91)
Vibration a/k m/s <sup>2</sup>	10.6/1.5	11.5/1.6
Max Air Consumption CFM/(L/S)	16.8/(7.9)	16.8/(7.9)
Avg Air Consumption CFM/(L/S)	2.8/(1.3)	2.8/(1.3)

## SI-3118A

SI-3118AM : Velcro pad model

Self Vacuum Dual Action Sander with 5" pad

## SI-3118-6A

SI-3118-6AM : Velcro pad model

Self Vacuum Dual Action Sander with 6" pad

SI-3118A/3118AM SI-3118-6A/3118-6AM

- Self vacuum dual action sander with 5" pad model (SI-3118A)
- The self generating suction system makes for a clean working environment
- Bar grip body
- Dust free operation protects the operator from the harmful particles of paint and filler
- The same quality features of SI-3118A with 6" pad model (SI-3118-6A)



Pad/Disc Size mm/(in.)	125/(5")	150/(6")
Spindle Size	5/16-24UNF	5/16-24UNF
Orbit Dia mm	6	6
Free Speed r.p.m.	8,000	8,000
Out Put Watt	569	569
Weight kg/(lb)	2.11/(4.65)	2.15/(4.74)
Noise Level dBA/(power)	81/(92)	81/(92)
Vibration a/k m/s <sup>2</sup>	9.0/1.4	10.1/1.5
Max Air Consumption CFM/(L/S)	17.4/(8.2)	17.4/(8.2)
Avg Air Consumption CFM/(L/S)	2.9/(1.4)	2.9/(1.4)

## SI-3113A

SI-3113AM : Velcro pad model

Self Vacuum Dual Action Sander with 5" pad

## SI-3113-6A

SI-3113-6AM : Velcro pad model

Self Vacuum Dual Action Sander with 6" pad

SI-3113A/3113AM SI-3113-6A/3113-6AM

- Self vacuum dual action sander with 5" pad model (SI-3113A)
- The self generating dust system helps create a clean working environment, protecting the operator from harmful paint and filler particles
- Light weight and compact palm grip body
- The same quality features of SI-3113 with 9 holes 6" leather pad model (SI-3113-6A)

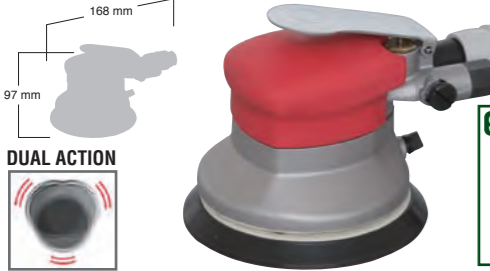

Pad/Disc Size mm/(in.)	125/(5")	150/(6")
Spindle Size	5/16-24UNF	5/16-24UNF
Orbit Dia mm	5	5
Free Speed r.p.m.	9,000	9,000
Out Put Watt	134	134
Weight kg/(lb)	1.57/(3.46)	1.59/(3.50)
Noise Level dBA/(power)	83/(94)	83/(94)
Vibration a/k m/s <sup>2</sup>	13.6/1.8	13.2/2.9
Max Air Consumption CFM/(L/S)	14.4/(6.8)	14.4/(6.8)
Avg Air Consumption CFM/(L/S)	2.4/(1.1)	2.4/(1.1)

## SI-3115R

SI-3115RM : Velcro pad model

Self Vacuum Geared Dual Action Sander with 5" pad

## SI-3115R-6

SI-3115R-6M : Velcro pad model

Self Vacuum Geared Dual Action Sander with 6" pad

SI-3115R SI-3115R-6

- Geared sander with 5" Velcro pad. (SI-3115R)
- Amazing power is generated with the gear mechanism
- The same quality features of SI-3115R with 6" velcro pad model (SI-3115R-6)



Pad/Disc Size mm/(in.)	125/(5")	150/(6")
Orbit Dia mm	4.4	4.4
Free Speed r.p.m.	1,000	1,000
Out Put Watt	148	148
Weight kg/(lb)	1.49/(3.27)	1.51/(3.33)
Noise Level dBA/(power)	86/(97)	86/(97)
Vibration a/k m/s <sup>2</sup>	11.2/1.6	9.7/2.9
Max Air Consumption CFM/(L/S)	13.8/(6.5)	13.8/(6.5)
Avg Air Consumption CFM/(L/S)	2.3/(1.1)	2.3/(1.1)

## SI-3101

SI-3101M : Velcro pad model

Dual Action Sander with 5" pad

## SI-3101-6

SI-3101-6M : Velcro pad model

Dual Action Sander with 6" pad

SI-3101/3101M SI-3101-6/3101-6M

- Light weight and compact palm grip body makes smooth and easy operation
- 5" pad also available 5mm orbit diameter for finish sanding (SI-3101)
- Ergonomic, compact and lightweight design for easy operation
- The same quality features of SI-3101 with 6" pad model (SI-3101-6)

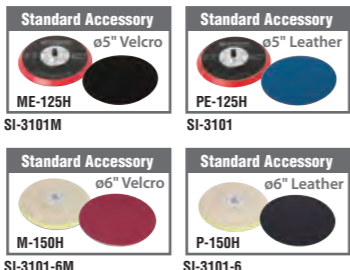

Pad/Disc Size mm/(in.)	125/(5")	150/(6")
Spindle Size	5/16-24UNF	5/16-24UNF
Orbit Dia mm	5	5
Free Speed r.p.m.	10,000	10,000
Out Put Watt	148	148
Weight kg/(lb)	0.92/(2.03)	0.94/(2.07)
Noise Level dBA/(power)	84/(95)	84/(95)
Vibration a/k m/s <sup>2</sup>	14.4/1.9	10.4/2.3
Max Air Consumption CFM/(L/S)	13.2/(6.2)	13.2/(6.2)
Avg Air Consumption CFM/(L/S)	2.2/(1.0)	2.2/(1.0)

## SI-3100

SI-3100M : Velcro pad model

Dual Action Sander with 6" pad

- Multi purpose dual action sander with bargrip
- 7mm orbit diameter for aggressive but smooth sanding
- The best and longest selling 6" random orbit model

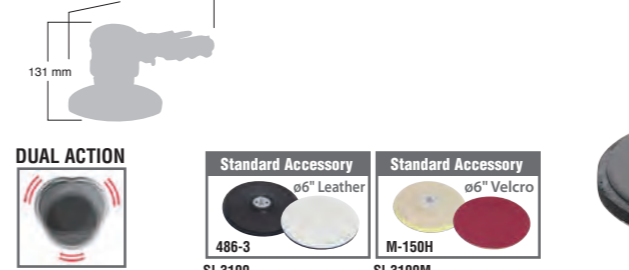

Pad/Disc Size mm/(in.)	150/(6")
Spindle Size	5/16-24UNF
Orbit Dia mm	7
Free Speed r.p.m.	10,000
Out Put Watt	542
Weight kg/(lb)	1.82/(4.01)
Noise Level dBA/(power)	75/(86)
Vibration a/k m/s <sup>2</sup>	10.2/1.5
Max Air Consumption CFM/(L/S)	13.8/(6.5)
Avg Air Consumption CFM/(L/S)	2.3/(1.1)

## SI-3111

SI-3111M : Velcro pad model

Self Vacuum Dual Action Sander with 5" pad

## SI-3111-6

SI-3111-6M : Velcro pad model

Self Vacuum Dual Action Sander with 6" pad

SI-3111/3111M SI-3111-6/3111-6M

- Self vacuum dual action sander
- The self generating dust system helps create a clean working environment, protecting the operator from harmful paint and filler particles
- Light weight and compact palm grip body
- The same quality features of SI-3111 with 6" pad model (SI-3111-6)



Pad/Disc Size mm/(in.)	125/(5")	150/(6")
Spindle Size	5/16-24UNF	5/16-24UNF
Orbit Dia mm	5	5
Free Speed r.p.m.	10,000	10,000
Out Put Watt	148	148
Weight kg/(lb)	1.27/(2.81)	1.29/(2.84)
Noise Level dBA/(power)	88/(99)	88/(99)
Vibration a/k m/s <sup>2</sup>	10.2/1.5	11.7/1.6
Max Air Consumption CFM/(L/S)	13.8/(6.5)	13.8/(6.5)
Avg Air Consumption CFM/(L/S)	2.3/(1.1)	2.3/(1.1)

## SI-3102M

SI-3102M : Velcro pad model

Mini Dual Action Sander with 3" pad

- Compact body design easy one hand operation



## SI-3112M

SI-3112M : Velcro pad model

Mini Self Vacuum Dual Action Sander with 3" pad

- Compact body design easy one hand operation



Pad/Disc Size mm/(in.)	75/(3")
Spindle Size	5/16-24UNF
Orbit Dia mm	3
Free Speed r.p.m.	12,000
Out Put Watt	153
Weight kg/(lb)	0.54/(1.19)
Noise Level dBA/(power)	85/(96)
Vibration a/k m/s <sup>2</sup>	7.4/1.2
Max Air Consumption CFM/(L/S)	15.0/(7.1)
Avg Air Consumption CFM/(L/S)	2.5/(1.2)

Pad/Disc Size mm/(in.)	75/(3")
Spindle Size	5/16-24UNF
Orbit Dia mm	3
Free Speed r.p.m.	12,000
Out Put Watt	153
Weight kg/(lb)	0.89/(1.96)
Noise Level dBA/(power)	92/(103)
Vibration a/k m/s <sup>2</sup>	6.6/1.1
Max Air Consumption CFM/(L/S)	15.0/(7.1)
Avg Air Consumption CFM/(L/S)	2.5/(1.2)

**SI-3001A**

Orbital Sander

- Light weight and compact palm grip orbital sander
- Paper size : 75mm x 110mm

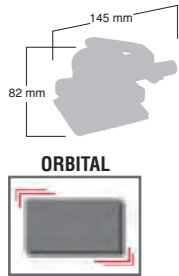

**SI-3001AM**

Orbital Sander with velcro pad



Pad/Disc Size mm/(in.)	75x100
Orbit Dia mm	4
Free Speed r.p.m.	10,000
Out Put Watt	148
Weight kg/ (lb)	0.80/(1.77)
Noise Level dBA/ (power)	82/(93)
Vibration a/k m/s <sup>2</sup>	6.2/1.1
Max Air Consumption CFM/ (L/S)	13.8 / (6.5)
Avg Air Consumption CFM/ (L/S)	2.3/(1.1)

**SI-3005**

Orbital Sander

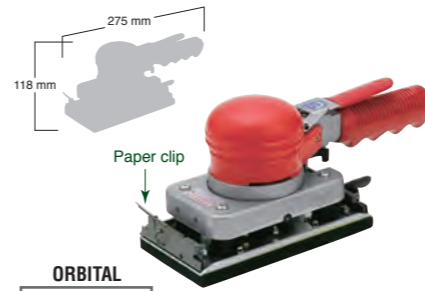

Pad/Disc Size mm/(in.)	90x165
Orbit Dia mm	5
Free Speed r.p.m.	11,000
Out Put Watt	289
Weight kg/ (lb)	1.87/(4.13)
Noise Level dBA/ (power)	88/(99)
Vibration a/k m/s <sup>2</sup>	21.1/2.8
Max Air Consumption CFM/ (L/S)	13.8 / (6.5)
Avg Air Consumption CFM/ (L/S)	2.3/(1.1)

**SI-3007**

SI-3007M : Velcro pad model

Orbital Sander

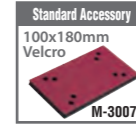
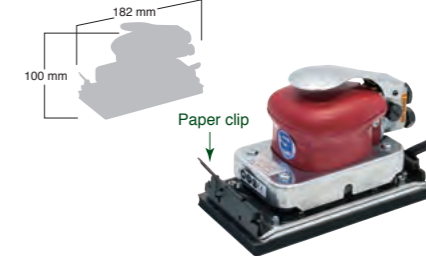

Pad/Disc Size mm/(in.)	95x175
Orbit Dia mm	5
Free Speed r.p.m.	11,000
Out Put Watt	275
Weight kg/ (lb)	1.82/(4.00)
Noise Level dBA/ (power)	86/(97)
Vibration a/k m/s <sup>2</sup>	27.5/3.2
Max Air Consumption CFM/ (L/S)	16.8 / (7.9)
Avg Air Consumption CFM/ (L/S)	2.8/(1.3)

**SI-3011A**

Self Vacuum Orbital Sander

- Self vacuum orbital sander with palm grip and leather pad
- Light weight and compact body
- Paper size : 75mm x 110mm
- Self generated suction system protects operator from harmful particles of paint and filler

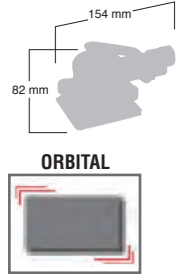

**SI-3011AM**

Self Vacuum Orbital Sander with velcro pad



Pad/Disc Size mm/(in.)	75x100
Orbit Dia mm	4
Free Speed r.p.m.	10,000
Out Put Watt	148
Weight kg/ (lb)	1.15/(2.53)
Noise Level dBA/ (power)	83/(94)
Vibration a/k m/s <sup>2</sup>	7.4/1.5
Max Air Consumption CFM/ (L/S)	15.0 / (7.1)
Avg Air Consumption CFM/ (L/S)	2.5/(1.2)

**SI-3018A**

Self Vacuum Orbital Sander

- Self vacuum orbital sander with bar grip
- Paper size : 100mm x 180mm
- With leather pad or Velcro pad



**SI-3018AM**

Self Vacuum Orbital Sander with velcro pad



Pad/Disc Size mm/(in.)	95x175
Orbit Dia mm	5
Free Speed r.p.m.	7,000
Out Put Watt	222
Weight kg/ (lb)	2.31/(5.09)
Noise Level dBA/ (power)	83/(94)
Vibration a/k m/s <sup>2</sup>	10.2/1.5
Max Air Consumption CFM/ (L/S)	18.6 / (8.8)
Avg Air Consumption CFM/ (L/S)	3.1/(1.5)

**SI-3003A**

Orbital Sander

- Palm grip orbital sander
- Paper size : 75mm x 110mm
- Powerful high quality air motor. 4mm orbit diameter

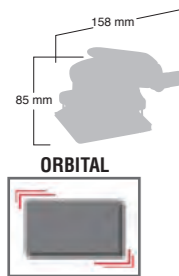

**SI-3003AM**

Orbital Sander with velcro pad



Pad/Disc Size mm/(in.)	75x100
Orbit Dia mm	4
Free Speed r.p.m.	9,000
Out Put Watt	134
Weight kg/ (lb)	1.05/(2.31)
Noise Level dBA/ (power)	75/(86)
Vibration a/k m/s <sup>2</sup>	6.9/1.1
Max Air Consumption CFM/ (L/S)	16.8 / (7.9)
Avg Air Consumption CFM/ (L/S)	2.8/(1.3)

**SI-3003B**

Orbital Sander

- Light weight & heavyduty orbital sander
- Paper size : 75mm x 110mm

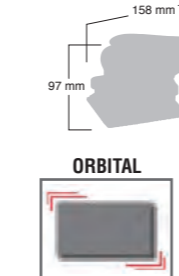

**SI-3003BM**

Orbital Sander with velcro pad



<b>Heavy Duty Type</b>	
Pad/Disc Size mm/(in.)	75x100
Orbit Dia mm	4
Free Speed r.p.m.	8,000
Out Put Watt	134
Weight kg/ (lb)	1.05/(2.31)
Noise Level dBA/ (power)	88/(99)
Vibration a/k m/s <sup>2</sup>	4.6/0.9
Max Air Consumption CFM/ (L/S)	16.8 / (7.9)
Avg Air Consumption CFM/ (L/S)	2.8/(1.3)

**SI-3013**

Self Vacuum Orbital Sander

- Self vacuum orbital sander with palm grip and leather pad model
- Paper size : 75mm x 110mm
- Self generated suction system protects operator from harmful particles of paint and filler

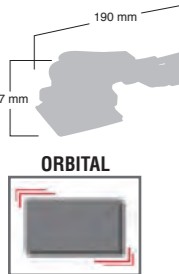

**SI-3013M**

Self Vacuum Orbital Sander with velcro pad



Pad/Disc Size mm/(in.)	75x100
Orbit Dia mm	4
Free Speed r.p.m.	8,000
Out Put Watt	134
Weight kg/ (lb)	1.46/(3.22)
Noise Level dBA/ (power)	88/(99)
Vibration a/k m/s <sup>2</sup>	4.6/0.9
Max Air Consumption CFM/ (L/S)	13.8 / (6.5)
Avg Air Consumption CFM/ (L/S)	2.3/(1.1)

**SI-2026**

Disc Sander



Pad/Disc Size mm/(in.)	125/(5")
Spindle Size	5/8-11UNC
Free Speed r.p.m.	5,500
Out Put Watt	491
Weight kg/ (lb)	1.50/(3.31)
Noise Level dBA/ (power)	88/(99)
Vibration a/k m/s <sup>2</sup>	3.4/0.8
Max Air Consumption CFM/ (L/S)	26.4 / (12.5)
Avg Air Consumption CFM/ (L/S)	4.4/(2.1)

**SI-2351**

Disc Sander



Pad/Disc Size mm/(in.)	180/(7")
Spindle Size	5/8-11UNC
Free Speed r.p.m.	4,500
Out Put Watt	458
Weight kg/ (lb)	2.13/(4.70)
Noise Level dBA/ (power)	80/(91)
Vibration a/k m/s <sup>2</sup>	4.9/0.9
Max Air Consumption CFM/ (L/S)	24.6 / (11.6)
Avg Air Consumption CFM/ (L/S)	4.1/(1.9)

SANDERS ACCESSORIES	PE-125H	ME-125H	P-125H	M-125H	P-150H	M-150H	PE-125HD	ME-125HD	P-150HD 6	M-150HD 6	P-150HD 9	M-150HD 9	P-150HD 3-4	M-150HD 3-4	M-150HDMH	1041CV-5	NP-150-120	NP-150-240	1040-54	570-42A	485-42	
SI-3121							★	☆													★	
SI-3121M							☆	★														★
SI-3121-6									☆	☆	☆	☆	☆	☆	★	★	★					★
SI-3101LG	★	☆																				
SI-3101LGM	☆	★																				
SI-3111LG							★	☆														★
SI-3111LGM							☆	★														★
SI-3101	★	☆	☆	☆																		
SI-3101M	☆	★	☆	☆																		
SI-3101-6					★	☆																
SI-3101-6M					☆	★																
SI-3111							★	☆														★
SI-3111M							☆	★														★
SI-3111-6									★	☆	☆	☆	☆	☆								★
SI-3111-6M									☆	★	☆	☆	☆	☆	☆							★
SI-3103A	★	☆	☆	☆																		
SI-3103AM	☆	★	☆	☆																		
SI-3103-6A					★	☆																
SI-3103-6AM					☆	★																
SI-3113A							★	☆														★
SI-3113AM							☆	★														★
SI-3113-6A									★	☆	☆	☆	☆	☆								★
SI-3113-6AM									☆	★	☆	☆	☆	☆	☆							★
SI-3118A							★	☆														★
SI-3118AM							☆	★														★
SI-3118-6A									★	☆	☆	☆	☆	☆								★
SI-3118-6AM									☆	★	☆	☆	☆	☆	☆							★
SI-3103B	☆	☆	★	☆																		
SI-3103BM	☆	☆	☆	★																		

★ : Standard ☆ : Option

SANDERS ACCESSORIES	M-150H	486-3	1140-14M	1140-59M	M-75H	M-75HD	P-3003	M-3003	P-3013D	M-3013D	475-22	P-3007	M-3007	477A-5EL	477A-5EM	136-45	820-52	1040-54	570-42A	485-42	
SI-3100	☆	★																			
SI-3100M	★	☆																			
SI-3115R			★																		★
SI-3115R-6				★																	★
SI-3102M					★																
SI-3112M						★															★
SI-3001A							★	☆													
SI-3001AM							☆	★													
SI-3011A									★	☆											★
SI-3011AM									☆	★											★
SI-3003A							★	☆													
SI-3003AM							☆	★													
SI-3013									★	☆											★
SI-3013M									☆	★											★
SI-3005											★										
SI-3007												★	☆								
SI-3007M												☆	★								
SI-3018A														★	☆						★
SI-3018AM														☆	★						★
SI-3003B							★	☆													
SI-3003BM							☆	★													
SI-2026																★					
SI-2351																	★				

BELT SANDER ACCESSORIES	181-45	509-45Z/40	509-45Z/60	509-45Z/80	509-45Z/100	509-45Z/120	509-60Z/12	507-58Z/40	507-58Z/60	507-58Z/80	507-58Z/100	507-58Z/120	505-56Z/40	505-56Z/60	505-56Z/80	505-56Z/100	505-56Z/120	509-130	509-131	509-132	509LK-106	
SI-2700	☆	☆	★	☆	☆	☆																
SI-2740	★	☆	★	☆	☆	☆																
SI-2741	★						★															
SI-2700L	☆																			★	★	★
SI-2700LS	☆																					★
SI-2800	☆							☆	★	☆	☆	☆	☆									
SI-2830	☆														★	☆	☆	☆				



★ : Standard ☆ : Option

**SI-2008EX**

Heavy Duty Mini Sander

- Angle head sander with 2" pad. Light and compact. It is useful for sanding and polishing work at the narrow place

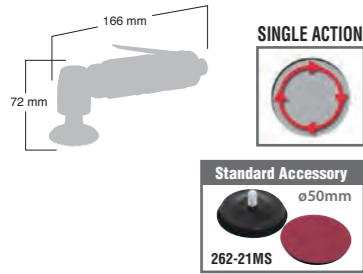

Pad/Disc Size mm/(in.)	50/(2")
Spindle Size	M6x1
Free Speed r.p.m.	14,500
Out Put Watt	175
Weight kg/ (lb)	0.57/(1.26)
Noise Level dBA/ (power)	83/(94)
Vibration a/k m/s <sup>2</sup>	4.0/0.9
Max Air Consumption CFM/ (L/S)	16.8/(7.9)
Avg Air Consumption CFM/ (L/S)	2.8/(1.3)

**SI-2107A**

Mini Sander

- Angle head dual action sander with 2" Velcro pad
- You can use 2" sanding paper, wool buff or sponge buff
- A good tool for sanding and polishing where space is limited
- Dual action for easy operation and a good finish



Pad/Disc Size mm/(in.)	50/(2")
Spindle Size	M6x1
Orbit Dia mm	3
Free Speed r.p.m.	14,000
Out Put Watt	127
Weight kg/ (lb)	0.55/(1.20)
Noise Level dBA/ (power)	85/(96)
Vibration a/k m/s <sup>2</sup>	3.8/0.9
Max Air Consumption CFM/ (L/S)	13.8/(6.5)
Avg Air Consumption CFM/ (L/S)	2.3/(1.1)

**SI-2108EX**

Heavy Duty Mini Sander with 3" pad

- Angle head dual action sander with 3" pad.
- The high durable gears included for long time use.

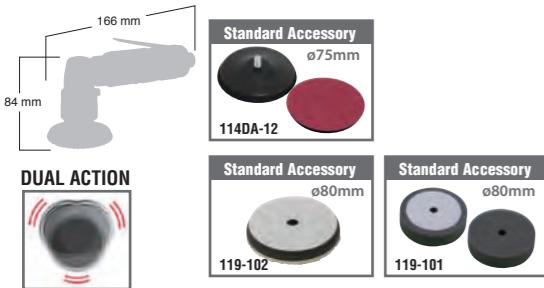

Pad/Disc Size mm/(in.)	75/(3")
Spindle Size	M6x1
Orbit Dia mm	3
Free Speed r.p.m.	15,500
Out Put Watt	175
Weight kg/ (lb)	0.62/(1.36)
Noise Level dBA/ (power)	85/(96)
Vibration a/k m/s <sup>2</sup>	18.5/2.3
Max Air Consumption CFM/ (L/S)	14.4/(6.8)
Avg Air Consumption CFM/ (L/S)	2.4/(1.1)

**SI-2108EX-2**

Heavy Duty Mini Sander with 2" pad

- Angle head dual action sander with 2" pad.
- The high durable gears included for long time use.
- Great for sanding & polishing in confined spaces.

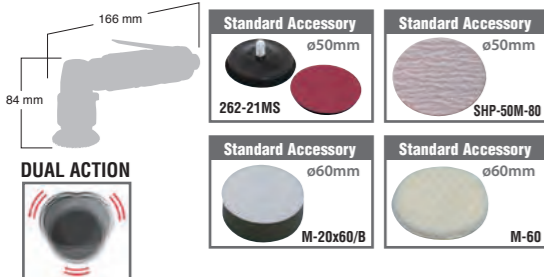

Pad/Disc Size mm/(in.)	50/(2")
Spindle Size	M6x1
Orbit Dia mm	3
Free Speed r.p.m.	15,500
Out Put Watt	175
Weight kg/ (lb)	0.62/(1.36)
Noise Level dBA/ (power)	85/(96)
Vibration a/k m/s <sup>2</sup>	18.5/2.3
Max Air Consumption CFM/ (L/S)	14.4/(6.8)
Avg Air Consumption CFM/ (L/S)	2.4/(1.1)

**SI-2210**

Disc Sander

- A long seller in the market. Very popular high speed disc sander
- Easy one hand operation
- Disc inside dia.



Pad/Disc Size mm/(in.)	75/(3")
Spindle Size	7/16-20UNF
Free Speed r.p.m.	19,000
Out Put Watt	475
Weight kg/ (lb)	0.99/(2.17)
Noise Level dBA/ (power)	91/(102)
Vibration a/k m/s <sup>2</sup>	3.8/1.0
Max Air Consumption CFM/ (L/S)	23.4/(11.0)
Avg Air Consumption CFM/ (L/S)	3.9/(1.8)

**SI-2201**

Disc Sander

- Designed for direct mounting of the 3M Roloc Pad
- No adaptors necessary

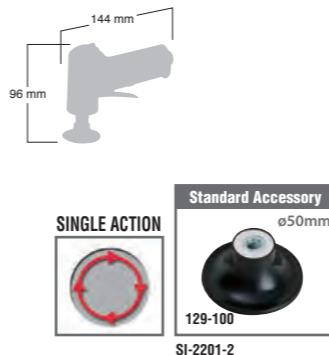

**SI-2201-2**

Disc Sander with 2" pad

Pad/Disc Size mm/(in.)	50/(2")
Spindle Size	1/4-20UNC
Free Speed r.p.m.	17,000
Out Put Watt	174
Weight kg/ (lb)	0.50/(1.10)
Noise Level dBA/ (power)	82/(93)
Vibration a/k m/s <sup>2</sup>	2.2/0.7
Max Air Consumption CFM/ (L/S)	15.0 / (7.1)
Avg Air Consumption CFM/ (L/S)	2.5/(1.2)

**SI-2202**

Disc Sander

- Ideal for the removal of rust, surface deposits, and welds in hard -to-reach areas
- Double-sided, adjustable speed settings provide variability for a broader range of applications
- Designed for direct mounting of the 3M Roloc Pad



Pad/Disc Size mm/(in.)	50/(2")
Spindle Size	1/4-20UNC
Free Speed r.p.m.	15,000
Out Put Watt	168
Weight kg/ (lb)	0.46
Noise Level dBA/ (power)	82/(93)
Vibration a/k m/s <sup>2</sup>	2.3/0.7
Max Air Consumption CFM/ (L/S)	15.0/(7.1)
Avg Air Consumption CFM/ (L/S)	2.5/(1.2)

**SI-2110S**

Mini Dual Action Sander

- Engineered for the most aggressive sanding applications
- Durable ball-bearing construction ensures, a smooth power delivery



Pad/Disc Size mm/(in.)	75/(3")
Spindle Size	M6x1
Orbit Dia mm	3
Free Speed r.p.m.	15,000
Out Put Watt	168
Weight kg/ (lb)	0.52
Noise Level dBA/ (power)	82/(93)
Vibration a/k m/s <sup>2</sup>	9.5/2.1
Max Air Consumption CFM/ (L/S)	15.0/(7.1)
Avg Air Consumption CFM/ (L/S)	2.5/(1.2)

**SI-2300**

Disc Sander

- Vertical grip for stable and easy operation sander with 7" disc



Pad/Disc Size mm/(in.)	180(7")
Spindle Size	5/8-11UNC
Free Speed r.p.m.	4,000
Out Put Watt	409
Weight kg/(lb)	2.27/(5.01)
Noise Level dBA/(power)	82/(93)
Vibration a/k m/s <sup>2</sup>	1.4/0.6
Max Air Consumption CFM/(L/S)	23.4/(11.0)
Avg Air Consumption CFM/(L/S)	3.9/(1.8)

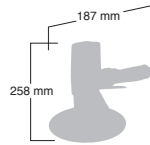

**SI-3200A**

Oscillation Sander

- Self suck system protects operator from harmful powder of paint and filler
- Oscillating mechanism tool with a triangular pad. For delicate and fine sanding work
- Special designed oscillation sander for narrow place and corner



Pad/Disc Size mm/(in.)	△75x70
Spindle Size	M8x1.25
Oscillating Angle	2.8°
Free Speed o.p.m.★	21,000
Out Put Watt	173
Weight kg/(lb)	0.65/(1.43)
Noise Level dBA/(power)	83/(94)
Vibration a/k m/s <sup>2</sup>	9.6/2.2
Max Air Consumption CFM/(L/S)	14.4/(6.8)
Avg Air Consumption CFM/(L/S)	2.4/(1.1)

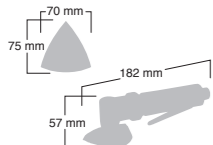

**SI-2322WR-LE**

Wet Sander Polisher

- Wet sander designed for stone sanding and polishing with water
- Supplied with 14mm thread spindle
- Waterproofed mechanism ensures a long working life
- Suitable for diamond polishing and dry marble polishing
- Water exits through spindle

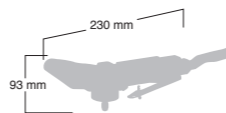

Pad/Disc Size mm/(in.)	φ80
Spindle Size	M14
Free Speed r.p.m.	5,500
Out Put Watt	435
Weight kg/(lb)	1.32/(2.91)
Noise Level dBA/(power)	88/(99)
Vibration a/k m/s <sup>2</sup>	1.7/0.6
Max Air Consumption CFM/(L/S)	24.0/(11.3)
Avg Air Consumption CFM/(L/S)	4.0/(1.9)

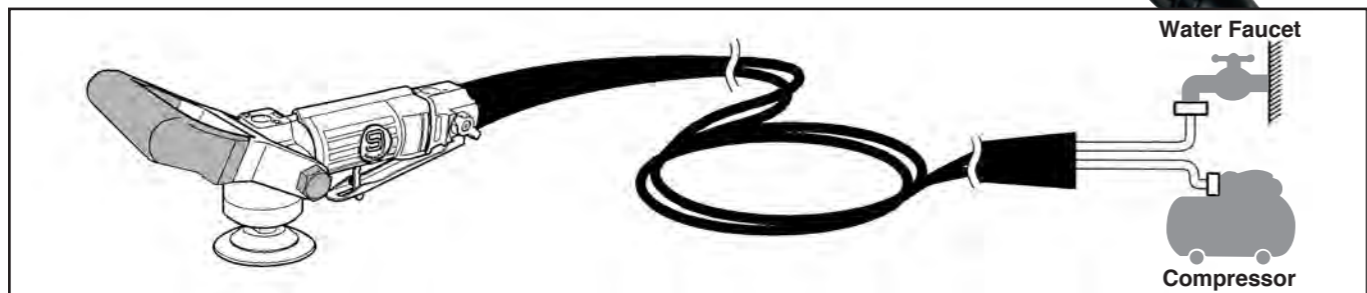

**SI-3310**

Mini Orbital Finishing Sander

- Special design for the polishing of very small scratches, marks, bubble or dust on fresh paint surface.
- φ30mm diameter head can help you see the exact point to sand it can reduce buffing area.

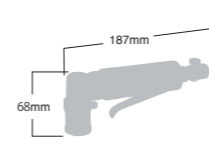

Pad/Disc Size mm/(in.)	φ30
Orbit Dia mm	3
Free Speed r.p.m.	10,000
Out Put Watt	127
Weight kg/(lb)	0.56/(1.23)
Noise Level dBA/(power)	83/(94)
Vibration a/k m/s <sup>2</sup>	10.2/2.1
Max Air Consumption CFM/(L/S)	7.2/(3.4)
Avg Air Consumption CFM/(L/S)	1.2/(0.6)



SANDERS ACCESSORIES	MESP-65	262-21MS	SHP-50M-40	TZ-3000	114DA-12	M-20x60B	M-60	119-101	119-102	170C-27	170C-30	820-52	129-100	118-3	115MB-6S	115MB-6H	1110A-80E
	φ65mm Sanding Disc	φ50mm Velcro Pad M6	φ30mm Sanding Paper	φ30mm Sanding Paper	φ75mm Velcro Pad M6	φ60mm Sponge Buff	φ60mm Wool Buff	φ80mm Sponge Buff	φ80mm Wool Buff	3"DiscPad	4"DiscPad	7"Back Disc	2"Disc Pad	Triangle Sanding Pad	φ30mm SoftPad	φ30mm HardPad	φ80mm Velcro Pad (M14 P=2)
SI-2008EX	☆	★	☆			☆	☆										
SI-2107A		★	★			★	★										
SI-2108EX					★			★	★								
SI-2108EX-2		★	★			★	★										
SI-2210										★	☆						
SI-2201														☆			
SI-2201-2														★			
SI-2202														☆			
SI-2202-2														★			
SI-2110S					★												
SI-2300												★					
SI-3200A														★			
SI-2322WR-LE																	☆
SI-3310				★											★	★	

★ : Standard ☆ : Option



**SHINANO INC. SANDER LINEUP**

Work	Finish			
	Light	Orbital		Heavy
Non Vacuum	SI-3001A	SI-3003A	SI-3005	SI-3003B
Self Vacuum	SI-3011A	SI-3013	SI-3018A	
Non Vacuum			SI-3007	

Work	Finish / Rough Finish	
	Light	
Non Vacuum	SI-3102M	
Self Vacuum	SI-3112M	

Work	Finish / Rough Finish				
	Light	Dual Action		Heavy	
5 inch	Non Vacuum	SI-3101 / SI-3101LG	SI-3103A	SI-3118A	SI-3103B
	Self Vacuum	SI-3111 / SI-3111LG	SI-3113A		
6 inch	Non Vacuum	SI-3101-6	SI-3103-6A	SI-3118-6A	
	Self Vacuum	SI-3111-6	SI-3113-6A	SI-3100	

Work	Finish / Rough Finish	
	Light~Heavy	
5 inch	SI-3121	
6 inch	SI-3121-6	

Work	Rough	
	Heavy	
5 inch	SI-3115R	
6 inch	SI-3115R-6	



**Sanding Mechanism**

Name	Shingle Sander	Dual Action Sander	Orbital Sander	Geared Action Sander	Belt Sander
Pad type	Round type pad	Round type pad	Square pad	Round type pad	No pad
Movement					
Sanding Style	Single rotation	Double eccentric rotation	Eccentric rotation	Double eccentric rotation	Endless track for one side
Sanding Power	Strong	Little strong	Little Weak	Strong	Strong
Depth	Deep	Shallow	Shallow	Deep	Deep
work	•Peeling •Deburring	Coarse sanding for surface	Coarse & finish sanding for surface	Coarse sanding for surface	•Peeling •Deburring
Orbit Dia	Nothing	3mm~6mm	4mm~5mm	4.4mm	Nothing
SI Model	SI-2026,2351, 2210,2300, 2008,2210, etc	SI-3100,3101,3111,3121 3103A,3113A,3105A, 3118A,2107A,2108, etc	SI-3001A,3013, 3018A,etc	SI-3115R,3115R-6	SI-2700,2700L, 2800,2830,2740 2700LS

SI-2415

**POLISHERS**

- GEARED DUAL ACTION POLISHER
- DUAL ACTION POLISHER
- SINGLE ACTION POLISHERS
- LIGHT SANDER POLISHER



# POLISHERS

Geared Dual Action Polisher • Dual Action Polisher • Single Action Polishers

## SI-2415

Geared Dual Action Polisher

- Geared polisher with 6" Velcro pad, 1,200r.p.m. low speed and high torque
- Designed for the wax polishing of painted motorcar body panels
- Either a wool buff or sponge buff can be used
- Geared dual action for easy operation



Buff Pad Size mm/(in.)	140/(6")
Orbit Dia mm	4.4
Free Speed r.p.m.	1,200
Weight kg/(lb)	1.45
Noise Level dBA/(power)	86/(97)
Vibration a/k m/s <sup>2</sup>	13.1/5.6
Max Air Consumption CFM/(L/S)	20.4/(9.6)
Avg. Air Consumption CFM/(L/S)	3.4/(1.6)

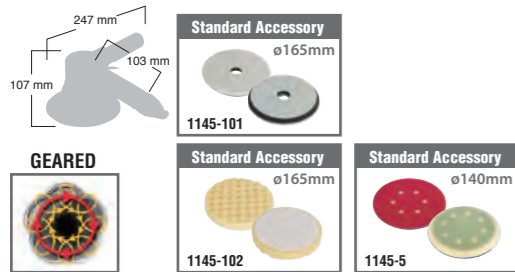

## SI-3100P

Dual Action Polisher

- Dual action polisher with 6" Velcro pad
- Designed for the wax polishing of painted motorcar body panel
- Either a wool buff or sponge buff can be used
- Uniform wax work with dual action
- Professional finish without special skill



Buff Pad Size mm/(in.)	150/(6")
Spindle Size Female	5/16-24UNF
Orbit Dia mm	6
Free Speed r.p.m.	8,000
Out Put Watt	542
Weight kg/(lb)	1.81/(3.99)
Noise Level dBA/(power)	75/(86)
Vibration a/k m/s <sup>2</sup>	6.7/3.1
Max Air Consumption CFM/(L/S)	13.8/(6.5)
Avg. Air Consumption CFM/(L/S)	2.3/(1.1)

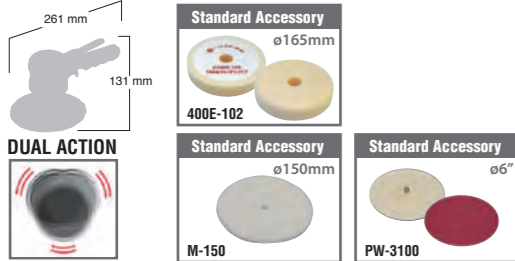

## SI-2221

Single Action Polisher

- Geared polisher with 3" Velcro pad
- Light and compact body
- Either a wool buff or sponge buff can be used
- Designed for Polishing and Buffing painted surface in confined areas
- The tool most suitable for repairing small scratch or dust on painted surfaces



Buff Pad Size mm/(in.)	75/(3")
Spindle Size Female	M6x1
Free Speed r.p.m.	4,500
Out Put Watt	203
Weight kg/(lb)	0.64/(1.42)
Noise Level dBA/(power)	83/(94)
Vibration a/k m/s <sup>2</sup>	1.4/0.6
Max Air Consumption CFM/(L/S)	15.0/(7.1)
Avg. Air Consumption CFM/(L/S)	2.5/(1.2)



## SI-2224S

Single Action Polisher

- Geared polisher with 3" Velcro pad
- Super light weight & compact design with solid composite body
- Based on two-layer molded rubber grip giving comfortable grip and reducing vibration



Buff Pad Size mm/(in.)	75/(3")
Spindle Size Female	M6x1
Free Speed r.p.m.	5,000
Out Put Watt	270
Weight kg/(lb)	0.60/(1.32)
Noise Level dBA/(power)	83/(94)
Vibration a/k m/s <sup>2</sup>	1.6/0.6
Max Air Consumption CFM/(L/S)	15.0/(7.1)
Avg. Air Consumption CFM/(L/S)	2.5/(1.2)

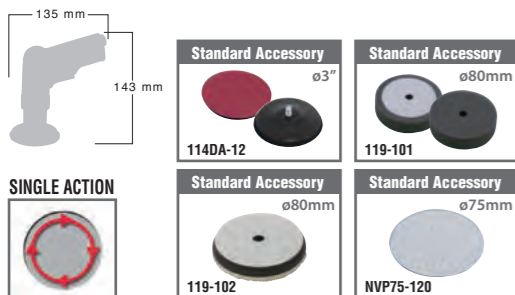

# POLISHERS

Single Action Polishers • Light Sander Polisher

## SI-2009EX

Single Action Polisher

- Compact body design for reduce weight
- Low Speed Single Action Sander
- New design for 3" pad size



Buff Pad Size mm/(in.)	75/(3")
Spindle Size Female	5/16-24UNF
Free Speed r.p.m.	2,600
OutPut Watt	180
Weight kg/(lb)	0.68/(1.49)
Noise Level dBA/(power)	77/(88)
Vibration a/k m/s <sup>2</sup>	1.1/0.6
Max Air Consumption CFM/(L/S)	15.0/(7.1)
Avg. Air Consumption CFM/(L/S)	2.5/(1.2)



## SI-2009H

Single Action Polisher

- Compact body design for reduce weight
- High Speed Single Action Sander
- New design for 3" buff pad size



Buff Pad Size mm/(in.)	75/(3")
Spindle Size Female	5/16-24UNF
Free Speed r.p.m.	5,000
OutPut Watt	190
Weight kg/(lb)	0.68/(1.50)
Noise Level dBA/(power)	77/(88)
Vibration a/k m/s <sup>2</sup>	2.3/0.7
Max Air Consumption CFM/(L/S)	12.6/(5.9)
Avg. Air Consumption CFM/(L/S)	2.1/(1.0)



## SI-2400

Single Action Polisher



Buff Pad Size mm/(in.)	180/(7")
Spindle Size Male	5/8-11UNC
Free Speed r.p.m.	2,000
Out Put Watt	511
Weight kg/(lb)	2.24/(4.94)
Noise Level dBA/(power)	83/(94)
Vibration a/k m/s <sup>2</sup>	1.8/0.6
Max Air Consumption CFM/(L/S)	24.0/(11.3)
Avg. Air Consumption CFM/(L/S)	4.0/(1.9)



## SI-2405

Light Sander Polisher

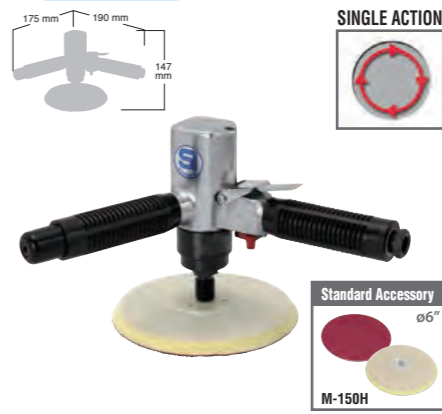

Buff Pad Size mm/(in.)	150/(6")
Spindle Size Female	5/16-24UNF
Free Speed r.p.m.	1,800
Out Put Watt	241
Weight kg/(lb)	1.17/(2.58)
Noise Level dBA/(power)	84/(95)
Vibration a/k m/s <sup>2</sup>	1.8/1.0
Max Air Consumption CFM/(L/S)	16.8/(7.9)
Avg. Air Consumption CFM/(L/S)	2.8/(1.3)

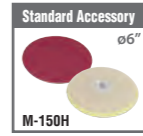

## SI-2451

Single Action Polisher



Buff Pad Size mm/(in.)	180/(7")
Spindle Size Male	5/8-11UNC
Free Speed r.p.m.	2,300
Out Put Watt	482
Weight kg/(lb)	2.13/(4.69)
Noise Level dBA/(power)	83/(94)
Vibration a/k m/s <sup>2</sup>	2.2/0.7
Max Air Consumption CFM/(L/S)	23.4/(11.0)
Avg. Air Consumption CFM/(L/S)	3.9/(1.8)



POLISHERS ACCESSORIES	M-150H	114DA-12	400E-102	M-150	M-75H	119-101	119-102	NVP75-120	1145-101	1145-102	1145-5	820-52	PW-3100
6" Velcro Pad 5/16-24UNF									★	★	★		
3" Velcro Pad Thread 6mm		★											★
Sponge Buff			★	★									
Wool Buff													
3" Velcro Pad 5/16-24UNF					★	★	★	★					
80mm Sponge Buff						★	★	★					
80mm Wool Buff							★	★					
75mm Sanding Paper #120								★					
165mm Wool Buff													
165mm Sponge Buff													
138mm Velcro Pad													
7" BackDisc												★	
6" Velcro Pad 5/16-24UNF	★												

★ : Standard ☆ : Option



SI-2515LA

# GRINDERS

**DIE GRINDERS**  
**CUT OFF GRINDER**  
**DISC GRINDERS**  
**MICRO GRINDERS**  
**WET GRINDER**

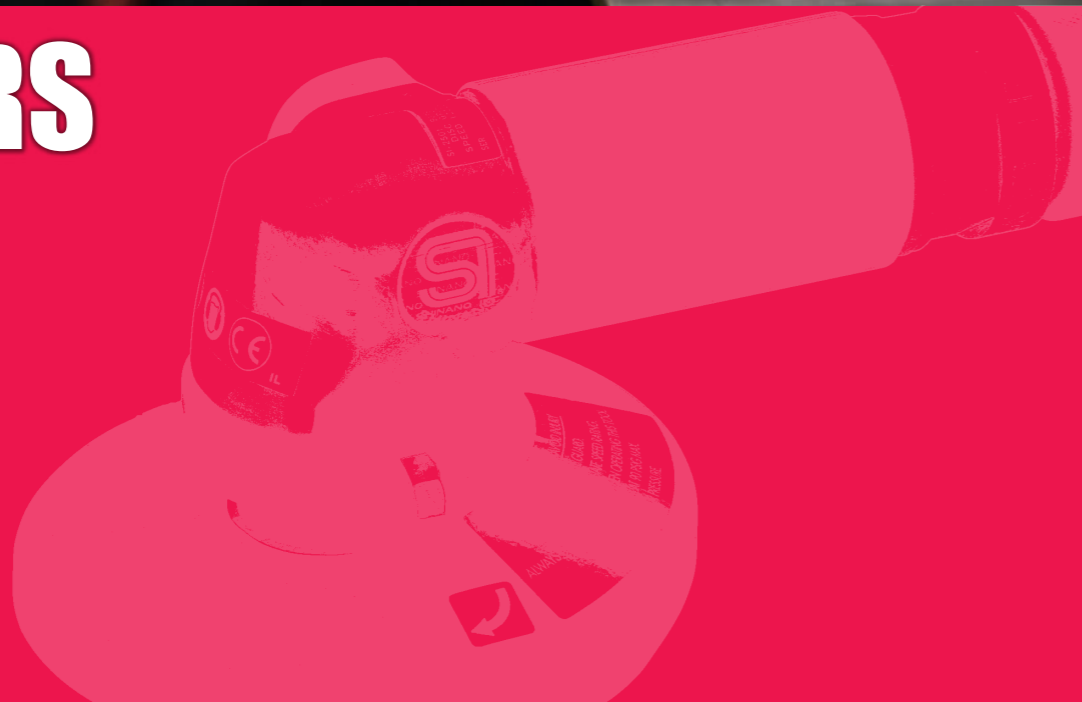

## GRINDERS Die Grinders

### SI-2001S Die Grinder

- Small body size die grinder
- 1/4" collet and 6mm collets are available

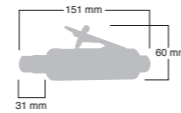

### SI-2001S-6 6mm Collet model

Collet Size	ø1/4"
Free Speed r.p.m. (MAX)	25,000
Output Watt	173
Weight kg/(lb)	0.37/(0.82)
Noise Level dBA/(power)	84/(95)
Vibration a/k m/s <sup>2</sup>	3.4/0.8
Max Air Consumption CFM/(L/S)	16.2/(7.6)
Avg Air Consumption CFM/(L/S)	2.7/(1.3)

### SI-2002EX Die Grinder

- Compact, lightweight, ergonomic design
- Double mold composite body cover for added vibration and cold temperature protection
- 1/4" collet and 6mm collets are available

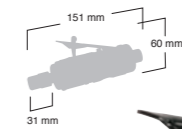

### SI-2002EX-6 6mm Collet model

Collet Size	ø1/4"
Free Speed r.p.m. (MAX)	27,000
Output Watt	219
Weight kg/(lb)	0.37/(0.83)
Noise Level dBA/(power)	84/(95)
Vibration a/k m/s <sup>2</sup>	2.3/0.7
Max Air Consumption CFM/(L/S)	15.6/(7.4)
Avg Air Consumption CFM/(L/S)	2.6/(1.2)

### SI-2011S Die Grinder

- Medium body size die grinder
- 1/4" collet and 6mm collets are available
- Rear exhaust directs air away from operator and work place
- Lever throttle with safety lock
- Compact, lightweight, ergonomic design and feather touch throttle lever for easy operation

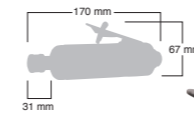

### SI-2011S-6 6mm Collet model

Collet Size	ø1/4"
Free Speed r.p.m. (MAX)	25,000
Output Watt	422
Weight kg/(lb)	0.60/(1.32)
Noise Level dBA/(power)	87/(98)
Vibration a/k m/s <sup>2</sup>	6.5/1.1
Max Air Consumption CFM/(L/S)	24.0/(11.3)
Avg Air Consumption CFM/(L/S)	4.0/(1.9)

### SI-2012EX Die Grinder

- Medium body size die grinder
- 1/4" collet and 6mm collets are available
- Compact, lightweight, ergonomic design and feather touch throttle lever
- Double mold composite body cover for added vibration and cold temperature protection

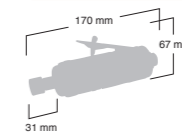

### SI-2012EX-6 6mm Collet model

Collet Size	ø1/4"
Free Speed r.p.m. (MAX)	25,000
Output Watt	388
Weight kg/(lb)	0.60/(1.31)
Noise Level dBA/(power)	87/(98)
Vibration a/k m/s <sup>2</sup>	3.9/1.3
Max Air Consumption CFM/(L/S)	24.0/(11.3)
Avg Air Consumption CFM/(L/S)	4.0/(1.9)

### SI-2015A Die Grinder

- Planetary geared die grinder. 5,500r.p.m. low speed and high torque
- 1/4" and 6mm collets are available
- Compact, lightweight, ergonomic design and feather touch throttle lever for easy operation
- A plastic body cover absorbs tool vibrations and protects your hand from the cold

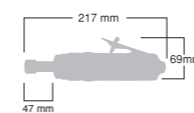

### SI-2015A-6 6mm Collet model

Collet Size	ø1/4"
Free Speed r.p.m. (MAX)	5,500
Output Watt	457
Weight kg/(lb)	0.91/(2.01)
Noise Level dBA/(power)	88/(99)
Vibration a/k m/s <sup>2</sup>	4.9/0.9
Max Air Consumption CFM/(L/S)	25.2/(11.9)
Avg Air Consumption CFM/(L/S)	4.2/(2.0)

### SI-2010 Die Grinder

- Compact, lightweight, ergonomic design and feather touch throttle lever for easy operation
- A plastic body cover absorbs tool vibrations and protects your hand from the cold

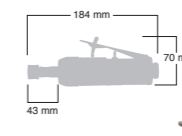

### SI-2010-6 6mm Collet model

Collet Size	ø1/4"
Free Speed r.p.m. (MAX)	23,000
Output Watt	247
Weight kg/(lb)	0.52/(1.14)
Noise Level dBA/(power)	83/(94)
Vibration a/k m/s <sup>2</sup>	5.9/1.0
Max Air Consumption CFM/(L/S)	10.8/(5.1)
Avg Air Consumption CFM/(L/S)	1.8/(0.8)

IMPACT WRENCHES  
DRIVERS  
RATCHET WRENCHES  
SANDERS  
PUSHERS  
GRINDERS  
SPINDLES  
CUTTING TOOLS  
OTHERS  
INDUSTRIAL TOOLS  
SOUND & VIBRATION  
MAINTENANCE CHECK  
QUALITY

## SI-2005HD

Die Grinder

## SI-2005HD-6

Die Grinder

6mm Collet model

- Small body size, angle head die grinder with a polymer grip cover
- High durability die grinder
- Compact, lightweight, ergonomic design and feather touch throttle lever for easy operation.
- A plastic body cover absorbs tool vibrations and protects your hand from the cold
- Lever throttle with safety lock

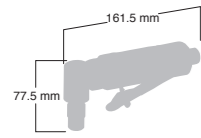

	SI-2005HD	SI-2005HD-6
Collet Size	ø1/4"	ø6mm
Free Speed r.p.m. (MAX)	20,000	20,000
Output Watt	200	200
Weight kg/ (lb)	0.56/(1.23)	0.56/(1.23)
Noise Level dBA/ (power)	81/(92)	81/(92)
Vibration a/k m/s <sup>2</sup>	7.3/1.2	7.3/1.2
Max Air Consumption CFM/ (L/S)	14.4/(6.8)	14.4/(6.8)
Avg Air Consumption CFM/ (L/S)	2.4/(1.1)	2.4/(1.1)

## SI-2006S

Die Grinder

## SI-2006S-6

6mm Collet model

- Small body size, angle head die grinder
- 1/4" collet and 6mm collets are available
- Compact, lightweight, ergonomic design and feather touch throttle lever for easy operation
- Lever throttle with safety lock

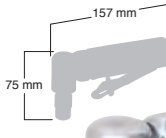

	SI-2006S	SI-2006S-6
Collet Size	ø1/4"	ø6mm
Free Speed r.p.m. (MAX)	20,000	20,000
Output Watt	127	127
Weight kg/ (lb)	0.49/(1.08)	0.49/(1.08)
Noise Level dBA/ (power)	83/(94)	83/(94)
Vibration a/k m/s <sup>2</sup>	7.4/1.6	7.4/1.6
Max Air Consumption CFM/ (L/S)	13.8/(6.5)	13.8/(6.5)
Avg Air Consumption CFM/ (L/S)	2.3/(1.1)	2.3/(1.1)

## SI-2022S

Die Grinder

## SI-2022S-6

6mm Collet model

- Die grinder with the extended shaft
- 1/4" collet and 6mm collets are available
- Special designed extended die grinder for unreachable place

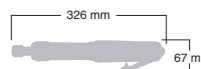

	SI-2022S	SI-2022S-6
Collet Size	ø1/4"	ø6mm
Free Speed r.p.m. (MAX)	24,000	24,000
Output Watt	537	537
Weight kg/ (lb)	1.34/(2.94)	1.34/(2.94)
Noise Level dBA/ (power)	89/(100)	89/(100)
Vibration a/k m/s <sup>2</sup>	4.1/0.9	4.1/0.9
Max Air Consumption CFM/ (L/S)	27.0/(12.7)	27.0/(12.7)
Avg Air Consumption CFM/ (L/S)	4.5/(2.1)	4.5/(2.1)

## SI-2033

Cut off Grinder

- A straight grinder designed for 3" cut off discs
- For cutting sheet metal or pipe
- Especially useful for cutting the exhaust pipe on motorcars
- Compact and lightweight body with lever throttle for safety operation

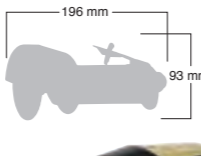

Disc Size mm/ (in.)	75/(3")
Spindle Size	ø9.5/(3/8")
Free Speed r.p.m. (MAX)	20,000
Output Watt	347
Weight kg/ (lb)	1.00/(2.21)
Noise Level dBA/ (power)	89/(100)
Vibration a/k m/s <sup>2</sup>	7.5/2.4
Max Air Consumption CFM/ (L/S)	24.0/(11.3)
Avg Air Consumption CFM/ (L/S)	4.0/(1.9)

## SI-2023

Die Grinder

## SI-2023-6

6mm Collet model

- Low Speed Die Grinder
- 1/4" collet and 6mm collets are available
- Sander with the extended shaft
- Special designed extended Sander for unreachable place

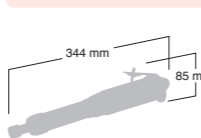

	SI-2023	SI-2023-6
Collet Size	ø1/4"	ø6mm
Free Speed r.p.m. (MAX)	6,000	6,000
Output Watt	435	435
Weight kg/ (lb)	1.70/(3.75)	1.70/(3.75)
Noise Level dBA/ (power)	90/(101)	90/(101)
Vibration a/k m/s <sup>2</sup>	4.0/0.9	4.0/0.9
Max Air Consumption CFM/ (L/S)	22.8/(10.8)	22.8/(10.8)
Avg Air Consumption CFM/ (L/S)	3.8/(1.9)	3.8/(1.9)

## SI-2501L

Disc Grinder  
Lever Switch

## SI-2501

Disc Grinder  
Rotary Switch

- Light weight 4" disc grinder with rotary throttle
- 40% lighter than SI-2500
- Speed governor assures safety operation
- Precise gear mechanism assures the highest power transfer, durability and reduced vibration



	SI-2501L	SI-2501
Disc Size mm/ (in.)	100/(4")	100/(4")
Spindle Size	M10x1.5	M10x1.5
Free Speed r.p.m. (MAX)	13,000	13,000
Output Watt	303	303
Weight kg/ (lb)	1.04/(2.29)	0.91/(2.01)
Noise Level dBA/ (power)	81/(92)	82/(93)
Vibration a/k m/s <sup>2</sup>	9.6/3.1	8.4/2.8
Max Air Consumption CFM/ (L/S)	16.2/(7.6)	13.2/(6.2)
Avg Air Consumption CFM/ (L/S)	2.7/(1.3)	2.2/(1.0)

## SI-2500L

Disc Grinder  
Lever Switch

## SI-2500

Disc Grinder  
Rotary Switch

- The high quality air motor used ensures the highest power and durability, while reducing vibration
- A trouble free tool for industry use

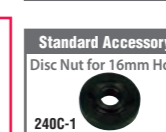
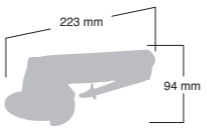

	SI-2500L	SI-2500
Disc Size mm/ (in.)	100/(4")	100/(4")
Spindle Size	M10x1.5	M10x1.5
Free Speed r.p.m. (MAX)	12,700	12,700
Output Watt	443	443
Weight kg/ (lb)	1.82/(4.02)	1.87/(4.11)
Noise Level dBA/ (power)	80/(91)	84/(95)
Vibration a/k m/s <sup>2</sup>	9.9/3.2	7.6/2.5
Max Air Consumption CFM/ (L/S)	16.2/(7.6)	14.4/(6.8)
Avg Air Consumption CFM/ (L/S)	2.7/(1.3)	2.4/(1.1)

## SI-2515LA

Disc Grinder

- 5" Disc grinder with safety lever throttle and 14mm thread spindle
- Speed governor assures safety operation
- Spindle lock button enable exchanging disc quickly
- Rear exhaust and lever throttle with safety lock
- Disc one push lock button model

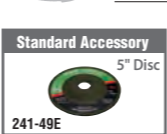
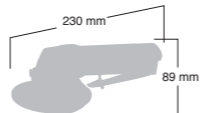

Disc Size mm/ (in.)	125/(5")
Spindle Size	M14x2
Free Speed r.p.m. (MAX)	12,000
Output Watt	570
Weight kg/ (lb)	1.65/(3.65)
Noise Level dBA/ (power)	85/(96)
Vibration a/k m/s <sup>2</sup>	11.0/3.6
Max Air Consumption CFM/ (L/S)	16.8/(7.9)
Avg Air Consumption CFM/ (L/S)	2.8/(1.3)

## SI-2505L

Disc Grinder

- 5" Disc grinder with safety lever throttle
- For this model because of the safety reason
- Speed governor assures safety operation
- Lever throttle with safety lock

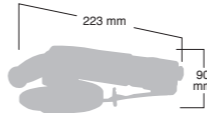

Disc Size mm/ (in.)	125/(5")
Spindle Size	ø22/(7/8")
Free Speed r.p.m. (MAX)	12,000
Output Watt	443
Weight kg/ (lb)	1.91/(4.22)
Noise Level dBA/ (power)	82/(93)
Vibration a/k m/s <sup>2</sup>	5.8/1.9
Max Air Consumption CFM/ (L/S)	19.8/(9.3)
Avg Air Consumption CFM/ (L/S)	3.3/(1.6)

## SI-2515WE

Wet Grinder

- Heavy duty rear exhaust wet grinder for use with 5" disc & diamond cup wheels
- Include air hose, water hose and wrenches
- Waterproof mechanism ensure a long working life



Disc Size mm/(in.)	125(5")
Spindle Size	M14x2
Free Speed r.p.m. (MAX)	10,000
Output Watt	570
Weight kg/ (lb)	2.01/(4.43)
Noise Level dBA/ (power)	85/(96)
Vibration a/k m/s <sup>2</sup>	11.0/3.6
Max Air Consumption CFM/ (L/S)	16.8/(7.9)
Avg Air Consumption CFM/ (L/S)	2.8/(1.3)

## SI-2600L

Disc Grinder

- 7" Disc grinder with safety lever throttle
- Speed governor assures safety operation
- High quality air motor assures high power, durability, reducing vibration and trouble free use



Disc Size mm/(in.)	180(7")
Spindle Size	M10x1.5
Free Speed r.p.m. (MAX)	7,500
Output Watt	754
Weight kg/ (lb)	3.24/(7.15)
Noise Level dBA/ (power)	97/(108)
Vibration a/k m/s <sup>2</sup>	4.0/1.3
Max Air Consumption CFM/ (L/S)	24.0/(11.3)
Avg Air Consumption CFM/ (L/S)	4.0/(1.9)

## SI-2050AG

Micro Grinder

- High speed angle head disc grinder with 30mm diameter disc
- 21,000r.p.m.
- For exact and delicate work

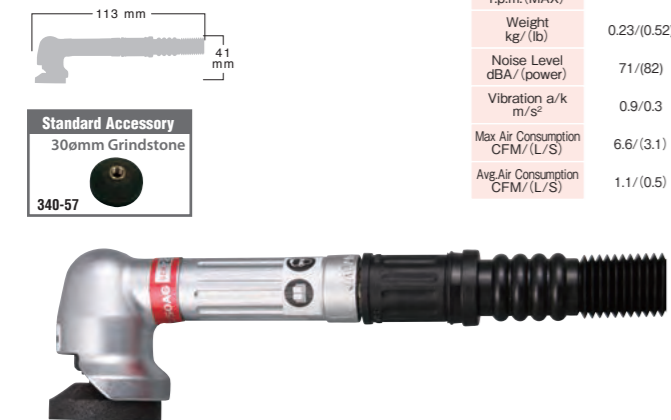

Disc Size mm/(in.)	ø30
Spindle Size	M7x0.75
Free Speed r.p.m. (MAX)	21,000
Weight kg/ (lb)	0.23/(0.52)
Noise Level dBA/ (power)	71/(82)
Vibration a/k m/s <sup>2</sup>	0.9/0.3
Max Air Consumption CFM/ (L/S)	6.6/(3.1)
Avg Air Consumption CFM/ (L/S)	1.1/(0.5)

## SI-2051SG

Micro Grinder

- High speed die grinder with 3mm or 1/8" collet
- Low vibration and noise allows extended use
- Option : 1/8" Dia collet

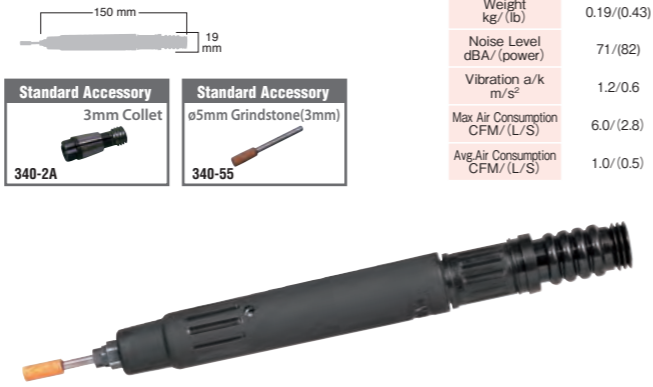

Collet Size	ø3 , 1/8"
Free Speed r.p.m. (MAX)	50,000
Weight kg/ (lb)	0.19/(0.43)
Noise Level dBA/ (power)	71/(82)
Vibration a/k m/s <sup>2</sup>	1.2/0.6
Max Air Consumption CFM/ (L/S)	6.0/(2.8)
Avg Air Consumption CFM/ (L/S)	1.0/(0.5)

### SHINANO INC. GRINDER LINEUP

Disc Size	Disc Grinder					Cut Off Grinder
	4 inch		5 inch		7 inch	
Safety Lever Type	2500L	2501L	2515LA	2505L	2600L	2033
Rotary Switch Type	2500	2501				

Power	Normal Type				Angle Type	
	Low	High	Light Duty	Heavy Duty	Extended Type	
Without Grip cover	2001S	2011S	2006S	2005HD		
	2002EX	2012EX				
With Grip cover	2010	2015A				
			2023	2022S		

GRINDERS ACCESSORIES	330-24	330-19	330-25	330-26	210-5-1A	175-29	240-6	240-71	240C-1	380-44	241-49	280-28	340-57	340-2A	340-2B	340-55	340-55A
	1/4" Collet	6mm Collet	1/8" Collet	3mm Collet	Dead handle set	3"Cut Disc	4"Disc 15mm Hole	4"Disc 16mm Hole	Disc Nut for 16mm Hole	Disc Nut for 15mm Hole	5"Disc	7"Disc	30mm Grindstone	3mm Collet	1/8" Collet	ø5mm Grindstone (3mm)	ø5mm Grindstone (1/8")
SI-2001S	★	☆	☆	☆													
SI-2001S-6	☆	★	☆	☆													
SI-2002EX	★	☆	☆	☆													
SI-2002EX-6	☆	★	☆	☆													
SI-2011S	★	☆	☆	☆													
SI-2011S-6	☆	★	☆	☆													
SI-2012EX	★	☆	☆	☆													
SI-2012EX-6	☆	★	☆	☆													
SI-2015A	★	☆	☆	☆	☆												
SI-2015A-6	☆	★	☆	☆	☆												
SI-2010	★	☆	☆	☆													
SI-2010-6	☆	★	☆	☆													
SI-2005HD	★	☆	☆	☆													
SI-2005HD-6	☆	★	☆	☆													
SI-2006S	★	☆	☆	☆													
SI-2006S-6	☆	★	☆	☆													
SI-2033						★											
SI-2022S	★	☆	☆	☆													
SI-2022S-6	☆	★	☆	☆													
SI-2023	★	☆	☆	☆													
SI-2023-6	☆	★	☆	☆													
SI-2501L										☆	★	★	☆				
SI-2501										★	☆	☆	★				
SI-2500L										☆	★	★	☆				
SI-2500										☆	★	★	☆				
SI-2515LA																★	
SI-2505L																★	
SI-2600L												★					
SI-2050AG													★				
SI-2051SG															★	☆	★

★ : Standard ☆ : Option



SI-5405-6

# DRILLS / SPOT MILLS

DRILLS  
SPOT MILLS



## DRILLS / SPOT MILLS Drills

### SI-2015AD Drill

- 3/8" capacity geared straight grip drill
- Specially designed tool for use in narrow place

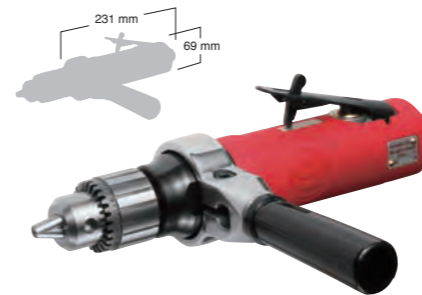

Free Speed r.p.m.	6,000
Chuck Size mm/(in.)	10/(3/8)
Spindle Size	3/8-24UNF
Drilling Cap mm/(in.)	6/(1/4)
Out Put Watt	457
Max Torque Nm/(ft-lb)	2.62/(1.92)
Weight kg/(lb)	1.06/(2.34)
Noise Level dBA/(power)	86/(97)
Vibration a/k m/s <sup>2</sup>	2.6/0.7
Max Air Consumption CFM/(L/S)	25.2/(11.9)
Avg Air Consumption CFM/(L/S)	4.2/(2.0)



### SI-5100A Drill

- 3/8" capacity geared pistol grip drill
- High speed drill for soft metal



Free Speed r.p.m.	5,000
Chuck Size mm/(in.)	10/(3/8)
Spindle Size	3/8-24UNF
Drilling Cap mm/(in.)	6/(1/4)
Out Put Watt	390
Max Torque Nm/(ft-lb)	3.06/(2.24)
Weight kg/(lb)	0.90/(1.99)
Noise Level dBA/(power)	84/(95)
Vibration a/k m/s <sup>2</sup>	3.4/0.8
Max Air Consumption CFM/(L/S)	19.8/(9.3)
Avg Air Consumption CFM/(L/S)	3.3/(1.6)



### SI-5200A Drill

- 1/2" capacity, geared, pistol grip drill
- 600r.p.m. low speed and high torque
- Ergonomic, compact, lightweight design with feather touch trigger for easy drill bit centering
- Precise planetary gear mechanism with needle roller assures high power, durability and reducing vibration
- Side handle for greater hand grip and control for easy operation



Free Speed r.p.m.	600
Chuck Size mm/(in.)	13/(1/2)
Spindle Size	3/8-24UNF
Drilling Cap mm/(in.)	13/(1/2)
Out Put Watt	390
Max Torque Nm/(ft-lb)	16.81/(12.40)
Weight kg/(lb)	1.42/(3.12)
Noise Level dBA/(power)	82/(93)
Vibration a/k m/s <sup>2</sup>	3.0/1.0
Max Air Consumption CFM/(L/S)	21.0/(9.9)
Avg Air Consumption CFM/(L/S)	3.5/(1.6)



### SI-5300A Drill

- 3/8" capacity geared pistol grip drill
- Heavy duty and the best selling model of the drills
- Precise planetary gear mechanism with needle roller assures high power, durability and reducing vibration
- Ergonomic, compact, lightweight design with feather touch trigger for easy centering



Free Speed r.p.m.	2,000
Chuck Size mm/(in.)	10/(3/8)
Spindle Size	3/8-24UNF
Drilling Cap mm/(in.)	10/(3/8)
Out Put Watt	378
Max Torque Nm/(ft-lb)	6.32/(4.64)
Weight kg/(lb)	0.91/(2.01)
Noise Level dBA/(power)	84/(95)
Vibration a/k m/s <sup>2</sup>	2.0/0.7
Max Air Consumption CFM/(L/S)	21.6/(10.2)
Avg Air Consumption CFM/(L/S)	3.6/(1.7)



### SI-5305A Reversible Drill

- 3/8" capacity geared pistol grip reversible drill
- Handy reverse mechanism
- Can be used for tapping work by utilizing the reverse function



Free Speed r.p.m.	2,000
Chuck Size mm/(in.)	10/(3/8)
Spindle Size	3/8-24UNF
Drilling Cap mm/(in.)	10/(3/8)
Out Put Watt	326
Max Torque Nm/(ft-lb)	F 5.24/(3.85) R 5.71/(4.19)
Weight kg/(lb)	1.02/(2.24)
Noise Level dBA/(power)	90/(101)
Vibration a/k m/s <sup>2</sup>	4.7/0.9
Max Air Consumption CFM/(L/S)	23.4/(11.0)
Avg Air Consumption CFM/(L/S)	3.9/(1.8)



### SI-5305-8A Reversible Drill

- 1/2" capacity geared pistol grip reversible drill. 800r.p.m. low speed and high torque.
- Handy reverse mechanism
- Can be used for tapping work by utilizing the reverse function
- Side handle for greater hand grip and control for easy operation



Free Speed r.p.m.	800
Chuck Size mm/(in.)	13/(1/2)
Spindle Size	3/8-24UNF
Drilling Cap mm/(in.)	13/(1/2)
Out Put Watt	326
Max Torque Nm/(ft-lb)	11.66/(8.60)
Weight kg/(lb)	1.45/(3.20)
Noise Level dBA/(power)	91/(102)
Vibration a/k m/s <sup>2</sup>	6.0/1.6
Max Air Consumption CFM/(L/S)	25.2/(11.9)
Avg Air Consumption CFM/(L/S)	4.2/(2.0)



IMPACT WRENCHES  
DRIVERS  
RATCHET WRENCHES  
SANDERS  
PUSHERS  
GRINDERS  
DRILLS  
SPOT MILLS  
CUTTING TOOLS  
OTHERS  
INDUSTRIAL TOOLS  
SOUND & VIBRATION  
MAINTENANCE CHECK  
QUALITY

## SI-5501 Drill SI-5506 Reversible Drill

- Super light weight & compact design with solid composite body
- Based on two-layer molded rubber grip giving comfortable grip and reducing vibration
- 3/8" capacity geared pistol grip drill
- A swivel lever for regulator can be used with one hand allowing easy operation



	SI-5501	SI-5506
Free Speed r.p.m.	2,400	1,700
Chuck Size mm/(in.)	10/(3/8)	10/(3/8)
Spindle Size	3/8-24UNF	3/8-24UNF
Drilling Cap mm/(in.)	10/(3/8)	10/(3/8)
Out Put Watt	234	146
Max Torque Nm/(ft-lb)	3.80/(2.79)	F 2.67/(1.96) R 2.58/(1.89)
Weight kg/(lb)	0.60/(1.32)	0.60/(1.32)
Noise Level dBA/(power)	80/(91)	80/(91)
Vibration a/k m/s <sup>2</sup>	2.6/0.7	1.9/0.6
Max Air Consumption CFM/(L/S)	13.2/(6.2)	14.4/(6.8)
Avg Air Consumption CFM/(L/S)	2.2/(1.0)	2.4/(1.1)



## SI-5405 Reversible Drill

- Triple idler planetary gearing for smooth operation and extended tool life.
- Body end mounted reverse lever for one hand directional changes.
- High quality 3/8" chuck.



Free Speed r.p.m.	1,500
Chuck Size mm/(in.)	10/(3/8)
Spindle Size	3/8-24UNF
Drilling Cap mm/(in.)	10/(3/8)
Out Put Watt	197
Max Torque Nm/(ft-lb)	F 4.83/(3.55) R 4.70/(3.45)
Weight kg/(lb)	1.08/(2.38)
Noise Level dBA/(power)	80/(91)
Vibration a/k m/s <sup>2</sup>	2.9/0.9
Max Air Consumption CFM/(L/S)	14.4/(6.8)
Avg Air Consumption CFM/(L/S)	2.4/(1.1)



## SI-5355 Angle Head Drill

- 3/8" capacity geared angle head drill
- Designed to facilitate drilling in confined places



Free Speed r.p.m.	1,200
Chuck Size mm/(in.)	10/(3/8)
Spindle Size	3/8-24UNF
Drilling Cap mm/(in.)	10/(3/8)
Out Put Watt	180
Max Torque Nm/(ft-lb)	F 4.54/(3.37) R 4.37/(3.21)
Weight kg/(lb)	0.94/(2.07)
Noise Level dBA/(power)	84/(95)
Vibration a/k m/s <sup>2</sup>	3.2/0.8
Max Air Consumption CFM/(L/S)	18.0/(8.5)
Avg Air Consumption CFM/(L/S)	3.0/(1.4)



## SI-5405-6 Reversible Drill

- Side handle assures easy operation and prevent wrist from injuries.
- Double reduction mechanism for exceptional power.
- 1/2" capacity standard rated grill chuck.

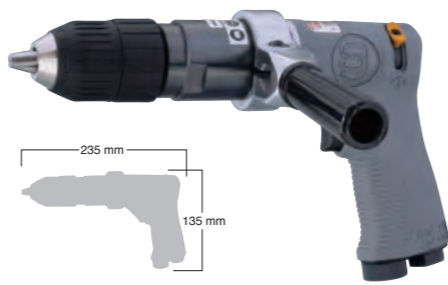

Free Speed r.p.m.	600
Chuck Size mm/(in.)	13/(1/2)
Spindle Size	3/8-24UNF
Drilling Cap mm/(in.)	13/(1/2)
Out Put Watt	186
Max Torque Nm/(ft-lb)	10.58/(7.80)
Weight kg/(lb)	1.41/(3.10)
Noise Level dBA/(power)	82/(93)
Vibration a/k m/s <sup>2</sup>	3.4/0.8
Max Air Consumption CFM/(L/S)	13.8/(6.5)
Avg Air Consumption CFM/(L/S)	2.3/(1.1)



## SI-5500 Drill

- 3/8" capacity geared pistol grip drill
- Light duty and reasonable price model
- Ergonomic, compact and lightweight design for easy operation



Free Speed r.p.m.	2,600
Chuck Size mm/(in.)	10/(3/8)
Spindle Size	3/8-24UNF
Drilling Cap mm/(in.)	10/(3/8)
Out Put Watt	258
Max Torque Nm/(ft-lb)	3.54/(2.53)
Weight kg/(lb)	0.79/(1.75)
Noise Level dBA/(power)	85/(96)
Vibration a/k m/s <sup>2</sup>	2.8/0.7
Max Air Consumption CFM/(L/S)	15.0/(7.1)
Avg Air Consumption CFM/(L/S)	2.5/(1.2)



## SI-5505 Reversible Drill

- 3/8" capacity geared pistol grip drill with solid composite body
- Supplied with keyless chuck
- Solid composite body absorbs the vibration remarkably and also protects your hand in a cold environment
- Keyless chuck enable the quick change of drill bits



Free Speed r.p.m.	1,900
Chuck Size mm/(in.)	10/(3/8)
Drilling Cap mm/(in.)	10/(3/8)
Out Put Watt	158
Max Torque Nm/(ft-lb)	F 2.05/(1.51) R 1.81/(1.33)
Weight kg/(lb)	0.75/(1.65)
Noise Level dBA/(power)	80/(91)
Vibration a/k m/s <sup>2</sup>	2.5/0.7
Max Air Consumption CFM/(L/S)	15.6/(7.4)
Avg Air Consumption CFM/(L/S)	2.6/(1.2)



## SI-5360 Angle Head Drill

- Easily perform drilling work in confined work spaces with a 58mm head height.
- Lever throttle with safety lock.
- High tolerance bearings offering low noise and vibration levels and superior performance at high speeds.
- Precisely ground transmission gears are made from highgrade nickel-chromium molybdenum steel with a specialised hardening process.
- Button design forward and reverse control.



## SI-5365 Reversible Angle Head Drill



	SI-5360	SI-5365
Free Speed r.p.m.	1,300	1,000
Chuck Size mm/(in.)	10/(3/8)	10/(3/8)
Spindle Size	3/8-24UNF	3/8-24UNF
Drilling Cap mm/(in.)	10/(3/8)	10/(3/8)
Out Put Watt	340	228
Weight kg/(lb)	1.22/(2.69)	1.23/(2.71)
Noise Level dBA/(power)	81/(92)	82/(94)
Vibration a/k m/s <sup>2</sup>	2.18/0.75	1.67/2.0
Max Air Consumption CFM/(L/S)	13.8/(6.5)	10.6/(5.0)
Avg Air Consumption CFM/(L/S)	2.3/(1.1)	1.8/(0.9)

## SI-5800 Spot Mill

- Specially designed to remove spot welds on body panels of motorcars. Work guide makes easy operation
- Easy to adjust depth of cut
- Special designed tool for spot welding separation
- With ø8mm Mill
- With sleeve for ø6.5mm Mill



Free Speed r.p.m.	1,600
Chuck Size mm/(in.)	8/(5/8)
Endmill Size	ø8
Milling Cap mm/(in.)	8/(5/16)
Out Put Watt	197
Weight kg/(lb)	1.80/(3.96)
Noise Level dBA/(power)	82/(93)
Vibration m/s <sup>2</sup>	<2.5
Max Air Consumption CFM/(L/S)	18.0/(8.5)
Avg Air Consumption CFM/(L/S)	3.0/(1.4)

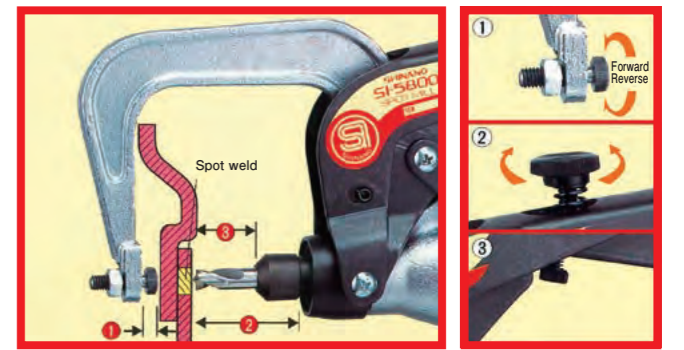
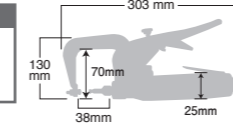

## SI-5500 Drill

- 3/8" capacity geared pistol grip drill
- Light duty and reasonable price model
- Ergonomic, compact and lightweight design for easy operation



Free Speed r.p.m.	2,600
Chuck Size mm/(in.)	10/(3/8)
Spindle Size	3/8-24UNF
Drilling Cap mm/(in.)	10/(3/8)
Out Put Watt	258
Max Torque Nm/(ft-lb)	3.54/(2.53)
Weight kg/(lb)	0.79/(1.75)
Noise Level dBA/(power)	85/(96)
Vibration a/k m/s <sup>2</sup>	2.8/0.7
Max Air Consumption CFM/(L/S)	15.0/(7.1)
Avg Air Consumption CFM/(L/S)	2.5/(1.2)



## SI-5850 Spot Mill

- Specially designed to remove spot welds on body panel of motorcars
- Work guide makes easy operation
- Easy to adjust depth of cut
- Special designed tool for spot welding separation
- With ø8mm Mill

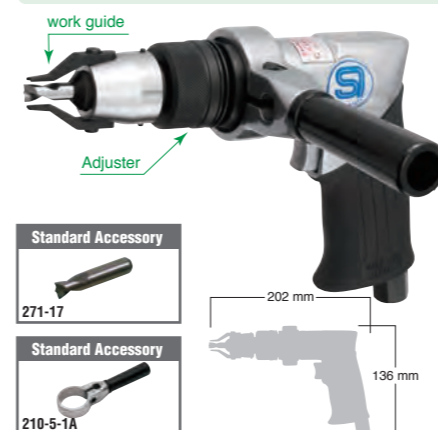

Free Speed r.p.m.	2,000
Chuck Size mm/(in.)	8/(5/8)
Endmill Size	ø8
Milling Cap mm/(in.)	8/(5/16)
Out Put Watt	390
Weight kg/(lb)	1.39/(3.06)
Noise Level dBA/(power)	83/(94)
Vibration m/s <sup>2</sup>	<2.5
Max Air Consumption CFM/(L/S)	7.8/(3.7)
Avg Air Consumption CFM/(L/S)	1.3/(0.6)

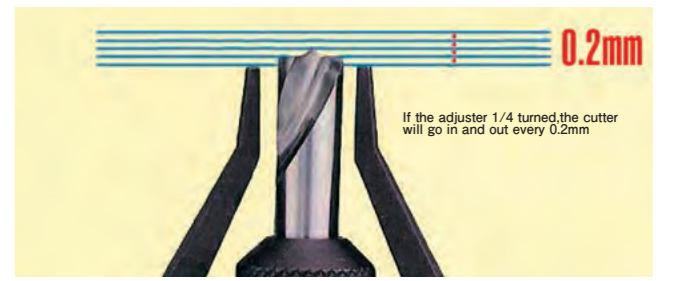

DRILLS / SPOT MILLS ACCESSORIES	KD-004	LX10	LM13W	KD-003A	KD-002	KK	KG1	100	210-5-1A	271-17
	 Chuck / Handle 3/8" Drill Chuck	 3/8" Keyless Chuck (Yukiwa)	 1/2" Keyless Chuck (Yukiwa)	 Chuck / Handle 1/2" Drill Chuck	 Chuck / Handle 3/8" Drill Chuck	 Chuck Handle for KD-004, & KD-003A	 Chuck Handle for KD-002	 Collet Driver	 Dead handle set	 ø8mm milling Cutter
 SI-2015AD	★	☆				★			★	
 SI-5100A	★	☆				★				
 SI-5200A			☆	★		★			★	
 SI-5300A	★	☆				★				
 SI-5305A	★	☆				★		☆	☆	
 SI-5305-8A			☆	★		★			★	
 SI-5501		☆			★		★			
 SI-5506		☆			★		★			
 SI-5405	☆	★				☆		☆	☆	
 SI-5405-6			★	☆		☆			★	
 SI-5500		☆			★		★			
 SI-5505	☆	★				☆				
 SI-5355	★	☆				★				
 SI-5360						★				
 SI-5365						★				
 SI-5800										★
 SI-5850									★	★

★ : Standard ☆ : Option



SI-4740

# CUTTING TOOLS

- SAWS
- SAWS & FILES
- NIBBLER
- SHEAR
- TRIMMER
- OSCILLATION CUTTER

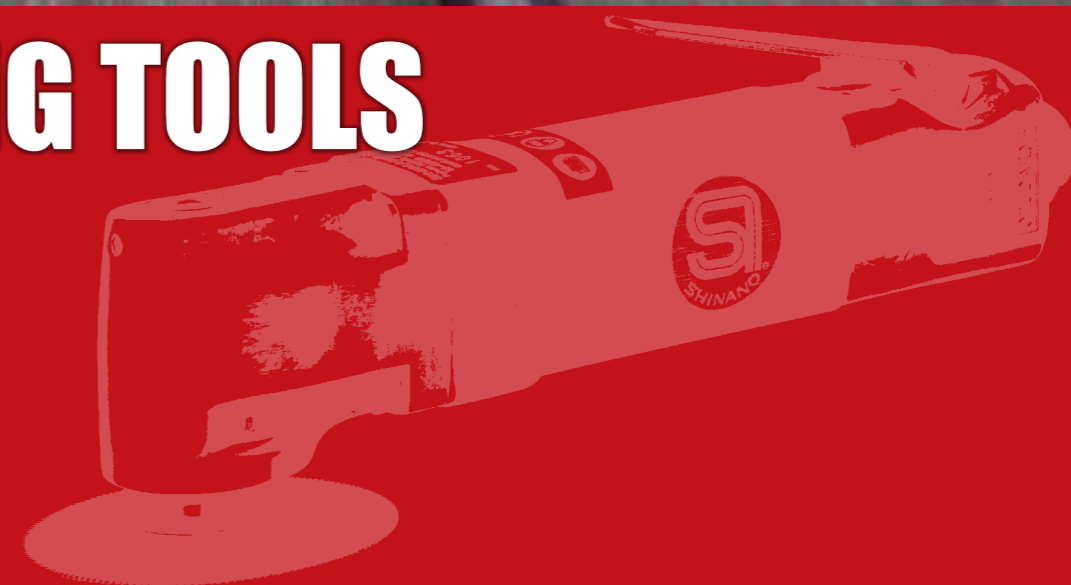



## SI-4700B

Saw

- This air saw is the most popular tool for cutting body panel of motorcars and one of longest selling models in the automotive repair market
- A popular tool at reasonable price

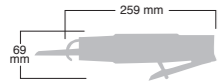

Cutting cap (Steel) mm/(in.)	3/(1/8)
Stroke length mm	10
Free Speed s.p.m. ★	10,000
Weight kg/(lb)	0.58/(1.27)
Noise Level dBA/(power)	82/(93)
Vibration a/k m/s <sup>2</sup>	22.6/2.7
Max Air Consumption CFM/(L/S)	7.2/(3.4)
Avg Air Consumption CFM/(L/S)	1.2/(0.6)

★s.p.m. (Stroke Per Minutes)

## SI-4730

Saw

- Air saw & file with rotary motor
- SI-4700B & SI-4710 are worked by piston but this model has a rotary air motor and makes working strokes through the gears
- Smooth operation, low vibration and low noise
- Amazing non-stop cutting with extremely low use fatigue

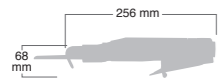

File Shank Opening mm/(in.)	5/(3/16)
Cutting cap (Steel) mm/(in.)	5/(3/16)
Stroke length mm	9
Free Speed s.p.m. ★	6,000
Out Put W	296
Weight kg/(lb)	0.92/(2.03)
Noise Level dBA/(power)	86/(97)
Vibration a/k m/s <sup>2</sup>	15.1/1.9
Max Air Consumption CFM/(L/S)	18.0/(8.5)
Avg Air Consumption CFM/(L/S)	3.0/(1.4)

★s.p.m. (Stroke Per Minutes)

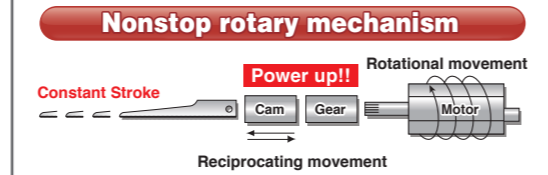

## SI-4710

Saw

- Air saw & file
- An improved model over the SI-4700B
- You can use saw blades, as well as 3 different files with this tool
- Low vibration and high power

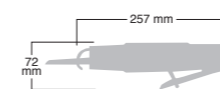

SI-4710 · SI-4710F

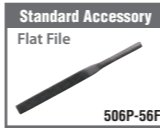

SI-4710F

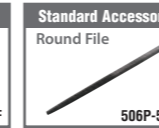

SI-4710F

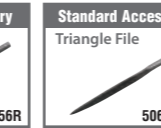

SI-4710F

SI-4710F · SI-4710F: Saw Blade and 3files set

## SI-4710F

Saw blade and 3files set

Saw & File

File Shank Opening mm/(in.)	5/(3/16)
Cutting cap (Steel) mm/(in.)	3/(1/8)
Stroke length mm	10
Free Speed s.p.m. ★	10,000
Weight kg/(lb)	0.80/(1.76)
Noise Level dBA/(power)	85/(97)
Vibration a/k m/s <sup>2</sup>	21.0/1.5
Max Air Consumption CFM/(L/S)	6.0/(2.8)
Avg Air Consumption CFM/(L/S)	1.0/(0.5)

★s.p.m. (Stroke Per Minutes)



## SI-4740

Saw

- World's smallest and lightest air saw
- Easy to use in tight place
- This model mechanism is same with the SI-4730, worked by rotary air motor and makes working strokes through the gears
- Only 5mm strokes and other parts are not damaged

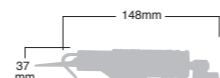

SI-4740 · SI-4740F

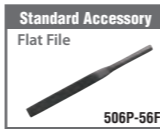

SI-4740F



SI-4740 · SI-4740F

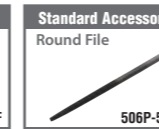

SI-4740F

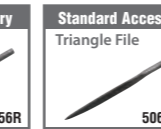

SI-4740F

SI-4740F · SI-4740F: Saw Blade and 3files set

## SI-4740F

Saw blade and 3files set

Saw & File

File Shank Opening mm/(in.)	5/(3/16)
Cutting cap (Steel) mm/(in.)	4/(5/32)
Stroke length mm	5
Free Speed s.p.m. ★	10,500
Out Put W	135
Weight kg/(lb)	0.52/(1.15)
Noise Level dBA/(power)	83/(94)
Vibration a/k m/s <sup>2</sup>	14.5/1.9
Max Air Consumption CFM/(L/S)	10.2/(4.8)
Avg Air Consumption CFM/(L/S)	1.7/(0.8)

★s.p.m. (Stroke Per Minutes)

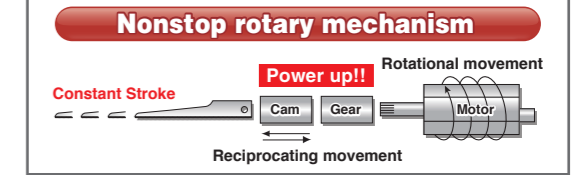

SI-4740F

# CUTTING TOOLS

Nibbler • Shear • Trimmer • Oscillation Cutter

## SI-4600 Nibbler



Cutting Width mm/(in.)	4.5/(3/16)	Noise Level dBA/(power)	88/(99)
Cutting cap mm/(in.)	1.6/(1/16)	Vibration a/k m/s <sup>2</sup>	8.6/1.3
Free Speed r.p.m.	2,600	Max Air Consumption CFM/(L/S)	19.8/(9.3)
Out Put Watt	316	Avg Air Consumption CFM/(L/S)	3.3/(1.6)
Weight kg/(lb)	1.00/(2.20)		

## SI-4500 Shear

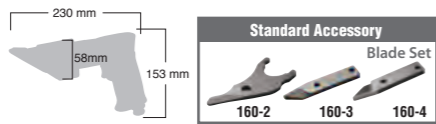

Cutting Width mm/(in.)	5.4/(7/32)	Noise Level dBA/(power)	83/(94)
Cutting cap mm/(in.)	1.6/(1/16)	Vibration a/k m/s <sup>2</sup>	4.9/0.9
Free Speed r.p.m.	2,000	Max Air Consumption CFM/(L/S)	21.0/(9.9)
Out Put Watt	378	Avg Air Consumption CFM/(L/S)	3.5/(1.6)
Weight kg/(lb)	1.26/(2.79)		

## SI-2018A Trimmer SI-2018A-6 6mm Collet model



Collet Size	ø1/4"	ø6mm
Free Speed r.p.m.	26,000	26,000
Output Watt	381	381
Weight kg/(lb)	0.91/(2.01)	0.91/(2.01)
Noise Level dBA/(power)	87/(98)	87/(98)
Vibration m/s <sup>2</sup>	<2.5	<2.5
Max Air Consumption CFM/(L/S)	25.2/(11.9)	25.2/(11.9)
Avg Air Consumption CFM/(L/S)	4.2/(2.0)	4.2/(2.0)

## SI-4300 Oscillation Cutter

Oscillation Cutter

- Oscillation cutting tool specially designed to cut the body panels of motorcars
- Two different cutting blades are supplied with the tool
- Specially designed tool for car repair shop
- The depth of the cut can be adjusted

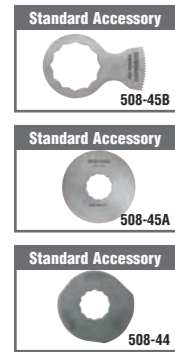
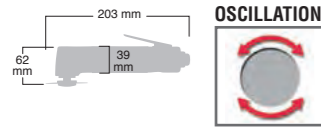

Disc Size mm	ø63
Oscillating Angle	2.8°
Free Speed o.p.m. ★	20,000
Weight kg/(lb)	0.89
Noise Level dBA/(power)	88/(99)
Vibration a/k m/s <sup>2</sup>	4.8/0.9
Max Air Consumption CFM/(L/S)	19.2/(9.1)
Avg Air Consumption CFM/(L/S)	3.2/(1.5)

★o.p.m. (Oscillation Per Minutes)

### 508-45A & 508-44



# CUTTING TOOLS

## CUTTING TOOLS ACCESSORIES

	506-49ASI	1025-49A	1025-50A	1026-49A	506P-56F	506P-56R	506P-56T	502-42	502-41	1026-50
<b>Saw blade 32T</b>	★	☆	☆							
<b>SI-4700B</b>	★	☆	☆							
<b>SI-4730</b>		★	☆		☆	☆	☆			
<b>SI-4710</b>	★	☆	☆		☆	☆	☆			
<b>SI-4710F</b>	★	☆	☆		★	★	★			
<b>SI-4740</b>				★	☆	☆	☆			★
<b>SI-4740F</b>				★	★	★	★			★
<b>SI-4600</b>								★	★	

## CUTTING TOOLS ACCESSORIES

	160-2	160-3	160-4	508-45A	508-45B	508-44	330-24	330-19	330-25	330-26
<b>Center Blade</b>										
<b>Right Blade</b>										
<b>Left Blade</b>										
<b>Cutting Wheel</b>				★	★	★				
<b>Cutting Blade</b>										
<b>Adjuster</b>										
<b>1/4" Collet</b>							★	☆	☆	☆
<b>6mm Collet</b>								★	☆	☆
<b>1/8" Collet</b>									☆	☆
<b>3mm Collet</b>										☆
<b>SI-4500</b>	★	★	★							
<b>SI-2018A</b>							★	☆	☆	☆
<b>SI-2018A-6</b>							☆	★	☆	☆
<b>SI-4300</b>				★	★	★				

★ : Standard ☆ : Option



SI-4600



SI-4500



SI-4160

# OTHERS

AIR HAMMER  
NEEDLE SCALERS  
HYDRO PUNCHER

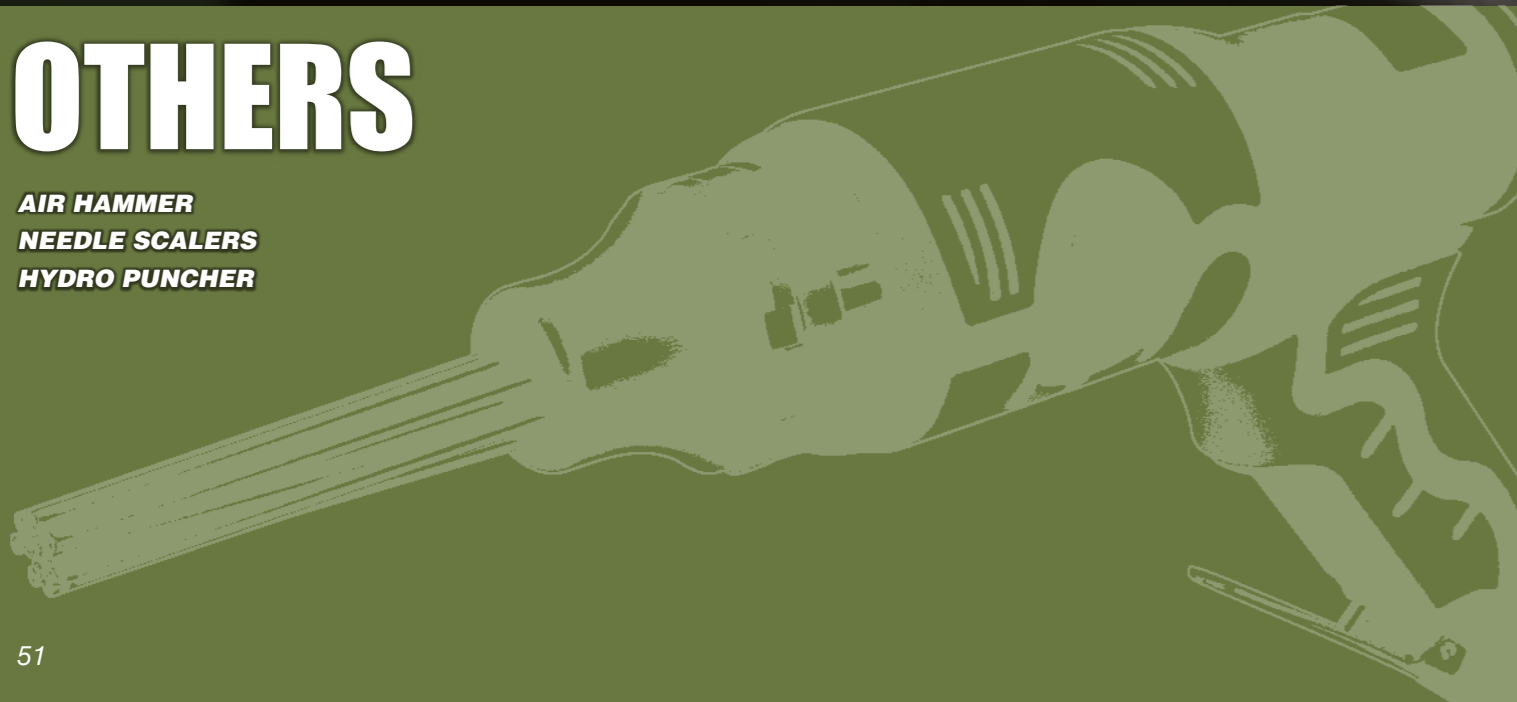

## OTHERS Air Hammer

### SI-4120A

Air Hammer

- Pistol grip air hammer for 10.2mm diameter chisels (.401" shank)
- Many kinds of the chisels are available as accessories
- High speed piston power of 2,600 times per min
- Powerful piston enable the tool to cope with many kinds of work

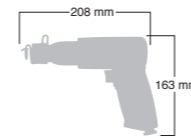

Shank Size in./.(mm)	.401/(10.2)
Stroke length mm	Max 10
Free Blow Speed s.p.m.	2,600
Weight kg/(lb)	1.60/(3.52)
Noise Level dBA/ (power)	104/(116)
Vibration m/s <sup>2</sup>	9.0
Max Air Consumption CFM/ (L/S)	18.0/(8.5)
Avg Air Consumption CFM/ (L/S)	3.0/(1.4)

### AIR HAMMER ACCESSORIES

#### Special Accessories .401 Shank CHISELS

All products are made in Japan.

No.801		TIE ROD TOOL	No.813		RIVET CUTTER
No.802		TAIL PIPE CUTTER	No.814		BLANK CHISEL
No.803		FORK 21/32" OPENING	No.815		SPOT WELD BREAKER
No.803J		FORK 15/16" OPENING	No.816		SHEET METAL B
No.804		BUSHING REMOVER	No.817		BUSHING DRIVER
No.805		SCRAPER	No.818		FLAT BEND
No.806		BUSHING SPLITTER	No.819		SHEET METAL PUNCH
No.807		SHEET METAL A	No.820		PANEL CLIPPER
No.808		MUFFER CUTTER	No.821		SMOOTHING HAMMER
No.809		DOUBLE EDGE PANEL CUTTER	No.822		STRAIGHT PUNCH
No.810		FLAT 7" LONG	No.823		PAINT SCRAPER
No.811		FLAT 9" LONG	No.824		SHOCK ABSORBER CHISEL
No.812		TAPER PUNCH	No.825		MOIL POINT

IMPACT WRENCHES  
DRIVERS  
RATCHET WRENCHES  
SANDERS  
PUSHERS  
GRINDERS  
DRILLS SPOTMILLS  
CUTTING TOOLS  
OTHERS  
INDUSTRIAL TOOLS  
SOUND & VIBRATION  
MAINTENANCE CHECK  
QUALITY

**SI-4160**

Needle Scaler

- Pistol type needle scaler is good for holding.
- Ergonomic design with rubber grip giving protects your hand from the cold.
- Excellent performance on uneven or rough surfaces.

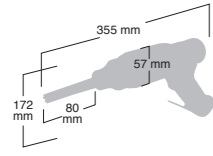

Attachment Included

φ3×180mm

820-11

OPTION

φ2×180mm

820-24

OPTION

φ2mm Needle Holder

820-23

Ergonomic Soft touch grip



Stroke length mm	Max 4.5
Free Blow Speed s.p.m.	3,300
Weight kg/ (lb)	2.19/(4.83)
Noise Level dBA/ (power)	95/(108)
Vibration m/s <sup>2</sup>	14.1
Max Air Consumption CFM/ (L/S)	8.4/(4.0)
Avg Air Consumption CFM/ (L/S)	1.4/(0.7)

**SI-4150EX**

Needle Scaler

- Straight grip needle scaler for removing rust or old paint. Excellent performance on uneven or rough surfaces.
- Ergonomic grip and composite body design.
- Simple mechanism for easy maintenance and needle replacement.

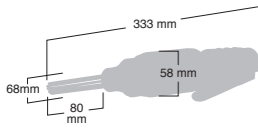

Attachment Included

φ3×180mm

820-11

OPTION

φ2×180mm

820-24

OPTION

φ2mm Needle Holder

820-23



Stroke length mm	Max 4.5
Free Blow Speed s.p.m.	3,500
Weight kg/ (lb)	2.06/(4.53)
Noise Level dBA/ (power)	97/(107)
Vibration m/s <sup>2</sup>	13.0
Max Air Consumption CFM/ (L/S)	7.8/(3.7)
Avg Air Consumption CFM/ (L/S)	1.3/(0.6)

**SI-4800**

Hydro Puncher

- Punching and flanging tool is useful for panel beating work.
- Best tool for welding work of car body.

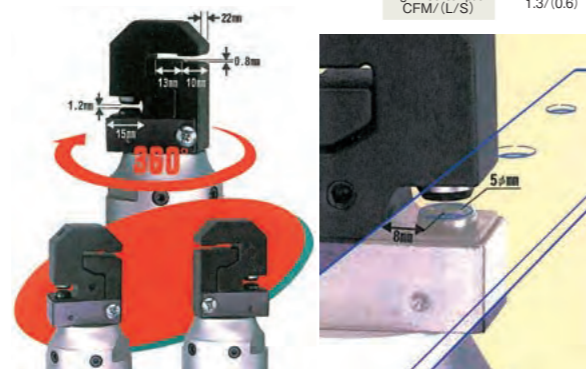
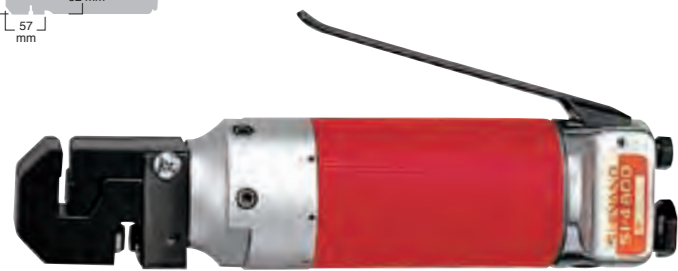
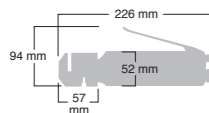

Punching cap	ø5 x 1.2mm
Cutting cap mm/ (in.)	1.2/(3/64)
Weight kg/ (lb)	1.01/(2.23)
Vibration m/s <sup>2</sup>	<2.5
Max Air Consumption CFM/ (L/S)	7.8/(3.7)
Avg Air Consumption CFM/ (L/S)	1.3/(0.6)



for Bridge industry

for Shipbuilding industry

for Building industry



**INDUSTRIAL AIR TOOLS**



for Airplane industry



for Welding industry



## DISC GRINDERS ANGLE GRINDERS.....P57~62

### AG2



SI-NO.	Switch type	Description	Spindle size	Disc size
AG2-U2P	Palm grip-safety lever(P)	2"Angle Disc Grinder	Φ9.53-1/4"-28UNF	50X4X9.53
AG2-U2R	Rotary twist switch(R)	2"Angle Disc Grinder	Φ9.53-1/4"-28UNF	50X4X9.53

### AG4



SI-NO.	Switch type	Description	Spindle size	Disc size
AG4-E2P	Palm grip-safety lever(P)	4"Angle Disc Grinder	Φ15.8-3/8-24UNF	100X6X15.8
AG4-A2P	Palm grip-safety lever(P)	4"Angle Disc Grinder	Φ15.8-M8-1.25	100X6X15.8
AG4-A2PJ	Palm grip-safety lever(P)	4"Angle Disc Grinder	Φ15-M8-1.25	100X6X15
AG4-E2R	Rotary twist switch(R)	4"Angle Disc Grinder	Φ15.8-3/8-24UNF	100X6X15.8
AG4-A2RJ	Rotary twist switch(R)	4"Angle Disc Grinder	Φ15-M8-1.25	100X6X15
AG4-A2R	Rotary twist switch(R)	4"Angle Disc Grinder	Φ15.8-M8-1.25	100X6X15.8
AG4-A2LJ	Long grip-safety lever(L)	4"Angle Disc Grinder	Φ15-M8-1.25	100X6X15
AG4-A2L	Long grip-safety lever(L)	4"Angle Disc Grinder	Φ15.8-M8-1.25	100X6X15.8
AG4-E2L	Long grip-safety lever(L)	4"Angle Disc Grinder	Φ15.8-3/8-24UNF	100X6X15.8

### AG5



SI-NO.	Switch type	Description	Spindle size	Disc size
AG5-E3P	Palm grip-safety lever(P)	5"Angle Disc Grinder	Φ22.2-M14-2	125X6/22.2
AG5-E4P	Palm grip-safety lever(P)	5"Angle Disc Grinder	Φ22.2-5/8-11UNC	125X6/22.2
AG5-A3P	Palm grip-safety lever(P)	5"Angle Disc Grinder	Φ22.2-M8-1.25	125X6/22.2
AG5-A3R	Rotary twist switch(R)	5"Angle Disc Grinder	Φ22.2-M8-1.25	125X6/22.2
AG5-E3L	Long grip-safety lever(L)	5"Angle Disc Grinder	Φ22.2-M14-2	125X6/22.2
AG5-E4L	Long grip-safety lever(L)	5"Angle Disc Grinder	Φ22.2-5/8-11UNC	125X6/22.2
AG5-A3L	Long grip-safety lever(L)	5"Angle Disc Grinder	Φ22.2-M8-1.25	125X6/22.2

### AG7



SI-NO.	Switch type	Description	Spindle size	Disc size
AG7-A4R	Rotary twist switch(R)	7"Angle Disc Grinder	Φ22.2-1/2-16UN	180X6X22.2
AG7-A4L	Long grip-safety lever(L)	7"Angle Disc Grinder	Φ22.2-1/2-16UN	180X6X22.2
AG7-E5L	Long grip-safety lever(L)	7"Angle Disc Grinder	Φ22.2-5/8-11UNC	180X6X22.2

## STRAIGHT GRINDERS.....P63

### SG3



SI-NO.	Switch type	Description	Spindle size	Disc size
SG3-2L	Safety lever(L)	2.5"Straight Disc Grinder	Φ9.53-W3/8-16	65 X 13 X 9.53
SG3-3L	Safety lever(L)	3"Straight Disc Grinder	Φ9.53-W3/8-16	75 X 13 X 9.53
SG3-2R	Rotary twist switch(R)	2.5"Straight Disc Grinder	Φ9.53-W3/8-16	65 X 13 X 9.53
SG3-3R	Rotary twist switch(R)	3"Straight Disc Grinder	Φ9.53-W3/8-16	75 X 13 X 9.53

## DIE GRINDERS

### COLLET TYPE.....P63

### AG2



SI-NO.	Switch type	Description	Spindle size	Collet size
AG2-C2P-6	Palm grip-safety lever(P)	Angle Die Grinder	W3/8-16	6mm
AG2-C2P-Q	Palm grip-safety lever(P)	Angle Die Grinder	W3/8-16	1/4"
AG2-C2R-6	Rotary twist switch(R)	Angle Die Grinder	W3/8-16	6mm
AG2-C2R-Q	Rotary twist switch(R)	Angle Die Grinder	W3/8-16	1/4"

### SG3



SI-NO.	Switch type	Description	Spindle size	Collet size
SG3-CL-6	Safety lever(L)	Straight Die Grinder	W3/8-24UNF	6mm
SG3-CL-Q	Safety lever(L)	Straight Die Grinder	W3/8-24UNF	1/4"
SG3-CR-6	Rotary twist switch(R)	Straight Die Grinder	W3/8-24UNF	6mm
SG3-CR-Q	Rotary twist switch(R)	Straight Die Grinder	W3/8-24UNF	1/4"

## DUAL ACTION SANDER.....P64



SI-NO.	Switch type	Description	Paper size
DS6-5L	Short lever	Dual Action Sander	125 φ mm

## DIE GRINDERS.....P65~66



### Angle Model

SI-NO.	Switch type	Description	Collet size
AG20E-6L-6	Safety lever(L)	Angle Die Grinder	6mm
AG20E-6L-Q	Safety lever(L)	Angle Die Grinder	1/4"
AG20E-6R-6	Rotary twist switch(R)	Angle Die Grinder	6mm
AG20E-6R-Q	Rotary twist switch(R)	Angle Die Grinder	1/4"



### Light Model

SI-NO.	Switch type	Description	Collet size
SG20E-6L-6	Safety lever(L)	Die Grinder	6mm
SG20E-6L-Q	Safety lever(L)	Die Grinder	1/4"
SG20E-6LL-6	Safety lever(L)	5"EXT Die Grinder	6mm
SG20E-6LL-Q	Safety lever(L)	5"EXT Die Grinder	1/4"
SG20E-6R-6	Rotary twist switch(R)	Die Grinder	6mm
SG20E-6R-Q	Rotary twist switch(R)	Die Grinder	1/4"
SG20E-6RL-6	Rotary twist switch(R)	5"EXT Die Grinder	6mm
SG20E-6RL-Q	Rotary twist switch(R)	5"EXT Die Grinder	1/4"



### Standard Model

SI-NO.	Switch type	Description	Collet size
SG40E-6L-6	Safety lever(L)	Die Grinder	6mm
SG40E-6L-Q	Safety lever(L)	Die Grinder	1/4"
SG40E-6LL-6	Safety lever(L)	5"EXT Die Grinder	6mm
SG40E-6LL-Q	Safety lever(L)	5"EXT Die Grinder	1/4"



### Power Model

SI-NO.	Switch type	Description	Collet size
SG60E-6L-6	Safety lever(L)	Die Grinder	6mm
SG60E-6L-Q	Safety lever(L)	Die Grinder	1/4"
SG60E-6LL-6	Safety lever(L)	5"EXT Die Grinder	6mm
SG60E-6LL-Q	Safety lever(L)	5"EXT Die Grinder	1/4"

## EDGE CUTTERS.....P67~68



### High Power Model

SI-NO.	Switch type	Description	Carbide tip type
4010	Rotary twist switch	Edge Cutter	R3 or C3
4010L	Safety lever(L)	Edge Cutter	R3 or C3



### Light Model

SI-NO.	Switch type	Description	Carbide tip type
4011	Rotary twist switch	Edge Cutter	R3 or C3
4011L	Safety lever(L)	Edge Cutter	R3 or C3

SHINANO INC.  
concepts for the  
Industrial range  
products are ;

- Productivity
- Accessibility
- Ergonomics
- Durability
- Safety

### Target market



Air craft

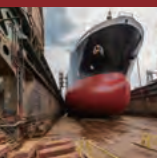

Shipyard



Bridge



Welding



construction

The Industrial range products  
have improved 150% on the  
accuracy compare with our  
automotive range products.

## Adjustable Silencer

The 4", 5" & 7" Industrial Angle Grinders feature front mounted 360 degree adjustable silencers. This enables directional control of exhaust air.

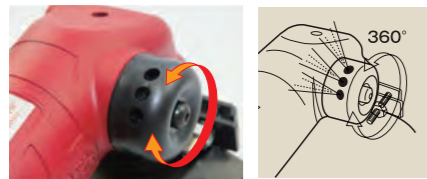

## Spindle Lock



The 2", 4", 5" & 7" Industrial Angle Grinders feature a Spindle lock button for quick and easy grinding disc replacement.

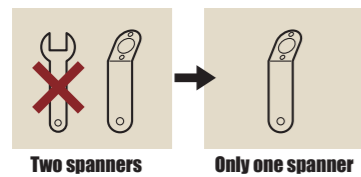

## High Precision Bearings & Gears

The Shinano Industrial range has been designed with new high tolerance bearings offering low noise and vibration levels and superior performance at high speeds. Precisely ground transmission gears are made from high grade nickel-chromium molybdenum steel with a specialised hardening process. These high quality specifications allow for a more compact design while maintaining heavy duty performance.



## Governed Motor

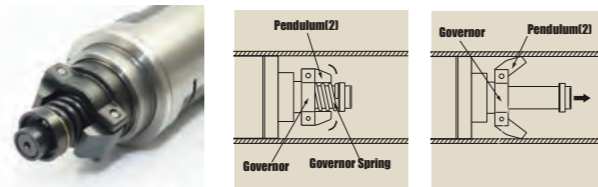

Speed governed motor delivers both higher torque levels and optimal disc RPM for optimum grinding performance.

## Switch Type



### Palm grip-safety lever(P)

The safety lever protects from inadvertent starting. When the lever is released, the lever will be locked automatically.

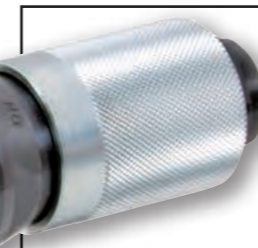

### Rotary twist switch(R)

Twist Switch is suitable for Continuous operation. No switch stress to operators.



### Long grip-safety lever(L)

The same safety lever system of palm grip. The distance between Wheel and handle is longer than Palm Grip type. It is more safety.

## Spindle Type

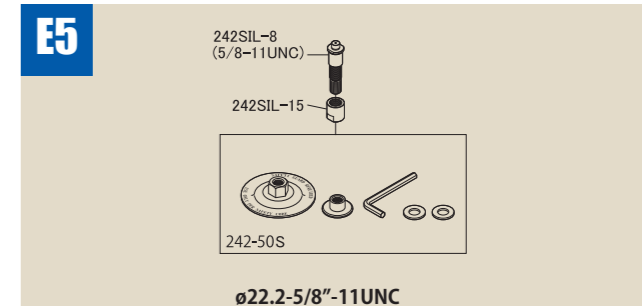
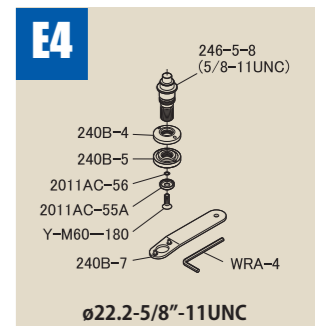
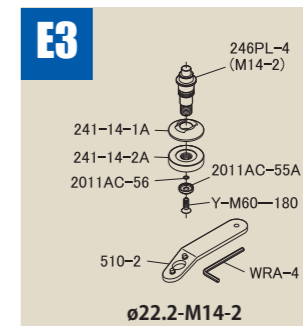
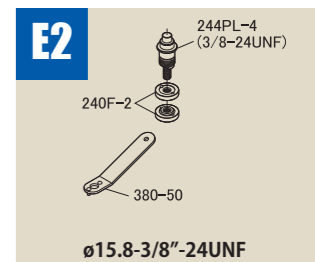
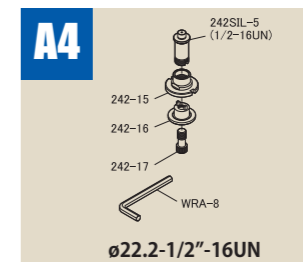
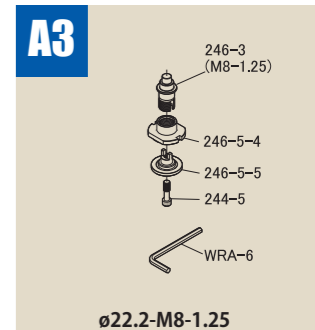
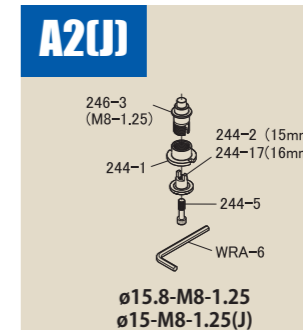
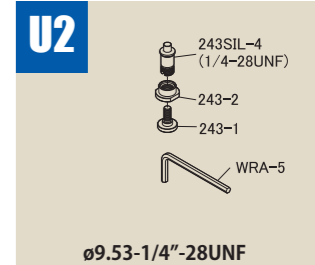
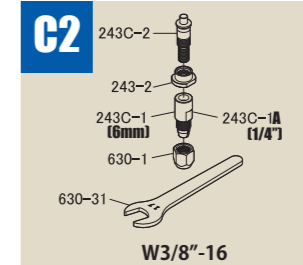

**Products No.**

**AG type**  
**S I - A G 4 - A 2 R**  
 J ø15mm (Diameter of disc hole)  
 R Rotary twist switch  
 P Palm grip-safety lever  
 L Long grip-safety lever  
**A 2 Spindle type**  
**2** Disc size : 2 inch. = 50mm  
**4** Disc size : 4 inch. = 100mm  
**5** Disc size : 5 inch. = 125mm  
**7** Disc size : 7 inch. = 180mm  
**G** Grinder  
**A** Angle

**SG type**  
**S I - S G 3 - C R**  
**S** Straight  
**G** Grinder  
**R** Rotary twist switch  
**L** Safety lever  
**C** Collet Die Grinder  
**2** Disc size : 2.5 inch. = 65mm  
**3** Disc size : 3 inch. = 75mm

## Low Profile Gearbox

Low Profile gearbox greatly increases the operators view of the work area.

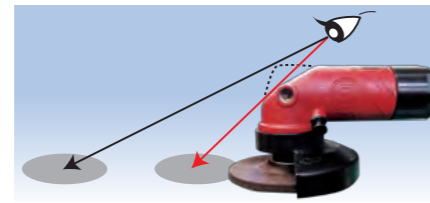

## SPINDLE TYPE & SIZE

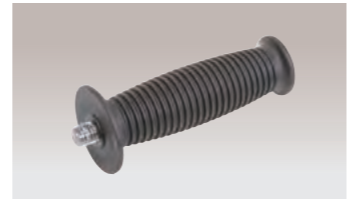
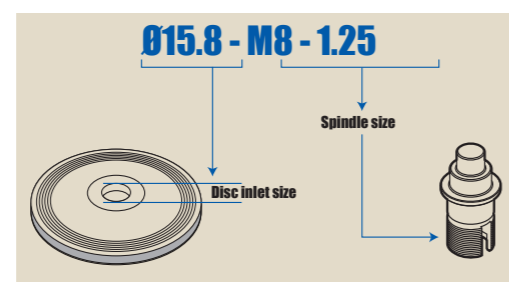

## Ergonomic Handle

It is good feeling for operating with soft grip.

## 2" (50mm) ANGLE DISC GRINDER

### SPINDLE TYPE

**U2** Ø 9.53 - 1/4" - 28UNF

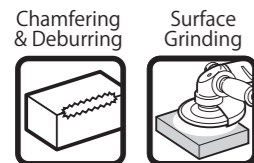

**SI-AG2-U2P**



Palm grip-safety lever

**SI-AG2-U2R**



Rotary twist switch

Option Attachment  
Parts No.243-30



Option Disc Pad  
Parts No.129-100

Option Attachment  
Parts No.243-W50  
2" Grinding Disc  
Disc Size : 50×4×9.53mm

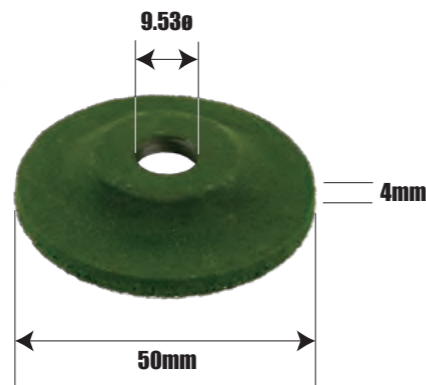

### Specifications

SI-No.	Free Speed (rpm)	Motor Watt (w)	Noise Level (db) Press/Power	Vibration(m/s <sup>2</sup> )		Air Consumption		Air Inlet Size (inch)	Length (mm)	Width (mm)	Height (mm)	Weight (g)
				a	K	CFM	L/Sec					
SI-AG2-U2P	15,000	240	84/95	7.97	1.28	18.4	8.7	1/4	170	68	65	630
SI-AG2-U2R	15,000	240	84/95	7.97	1.28	18.4	8.7	1/4	170	68	65	640

Noise levels according to ISO 15744:2008,ISO 11203:2009

## 4" (100mm) ANGLE DISC GRINDER

### SPINDLE TYPE

**A2** Ø 15.8 - M8 - 1.25

**E2** Ø 15.8 - 3/8" - 24UNF

**A2(U)** Ø 15 - M8 - 1.25

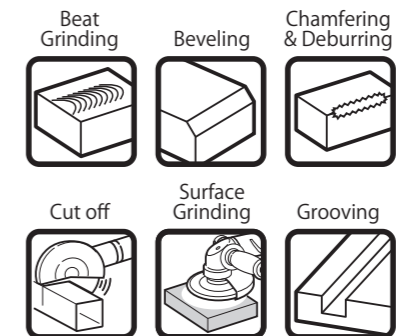

**SI-AG4-E2P**  
**SI-AG4-A2P**  
**SI-AG4-A2PJ**



Palm grip-safety lever

**SI-AG4-A2RJ**  
**SI-AG4-A2R**  
**SI-AG4-E2R**

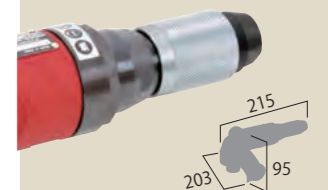

Rotary twist switch

**SI-AG4-A2LJ**  
**SI-AG4-A2L**  
**SI-AG4-E2L**



Long grip-safety lever



Standard Accessorie

Parts No.240-71E  
4" Grinding Disc

Disc Size : 100×6×15.8mm  
※This grinding disc is not attached to "J-type".

J-type : SI-AG4-A2PJ, SI-AG4-A2RJ, SI-AG4-A2LJ  
Disc Size : 100×6×15mm

### Specifications

SI-No.	Free Speed (rpm)	Motor Watt (w)	Noise Level (db) Press/Power	Vibration(m/s <sup>2</sup> )		Air Consumption		Air Inlet Size (inch)	Length (mm)	Width (mm)	Height (mm)	Weight (g)
				a	K	CFM	(L/sec)					
SI-AG4-E2P	13,500	600	84/95	5.54/13.9	1.8/4.51	20.6	9.7	1/4	214	203	95	1890
SI-AG4-A2P	13,500	600	84/95	5.54/13.9	1.8/4.51	20.6	9.7	1/4	214	203	95	1880
SI-AG4-A2PJ	13,500	600	84/95	5.54/13.9	1.8/4.51	20.6	9.7	1/4	214	203	95	1880
SI-AG4-A2RJ	13,500	600	84/95	5.54/13.9	1.8/4.51	21.3	10	3/8	215	203	95	1750
SI-AG4-A2R	13,500	600	84/95	5.54/13.9	1.8/4.51	21.3	10	3/8	215	203	95	1750
SI-AG4-E2R	13,500	600	84/95	5.54/13.9	1.8/4.51	21.3	10	3/8	215	203	95	1750
SI-AG4-A2LJ	13,500	600	84/95	5.54/13.9	1.8/4.51	19.1	9	3/8	276	203	95	1890
SI-AG4-A2L	13,500	600	84/95	5.54/13.9	1.8/4.51	19.1	9	3/8	276	203	95	1890
SI-AG4-E2L	13,500	600	84/95	5.54/13.9	1.8/4.51	19.1	9	3/8	276	203	95	1900

Noise levels according to ISO 15744:2008,ISO 11203:2009 Vibration level according to ISO 28927-1

## 5" (125mm) ANGLE DISC GRINDER



### SPINDLE TYPE

**A3** Ø 22.2 - M8 - 1.25

**E3** Ø 22.2 - M14 - 2

**E4** Ø 22.2 - 5/8" - 11UNC

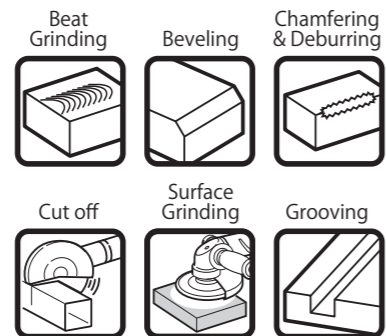

**SI-AG5-E3P**  
**SI-AG5-E4P**  
**SI-AG5-A3P**



**SI-AG5-A3R**

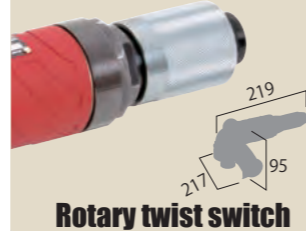

**SI-AG5-E3L**  
**SI-AG5-E4L**  
**SI-AG5-A3L**

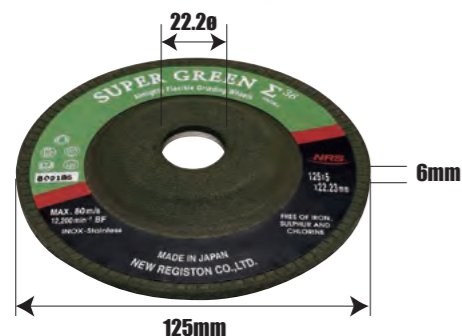

Standard Accessorie  
**Parts No.241-49E**  
**5" Grinding Disc**  
Disc Size : 125×6×22.2mm

### Specifications

SI-No.	Free Speed (rpm)	Motor Watt (w)	Noise Level (db) Press/Power	Vibration(m/s <sup>2</sup> )		Air Consumption		Air Inlet Size (inch)	Length (mm)	Width (mm)	Height (mm)	Weight (g)
				a Body/Grip	K Body/Grip	CFM	(L/sec)					
SI-AG5-E3P	12,000	800	85.5/96.5	7.56/18.9	2.49/6.22	25.5	12	1/4	223	217	95	2050
SI-AG5-E4P	12,000	800	85.5/96.5	7.56/18.9	2.49/6.22	25.5	12	1/4	223	217	95	2050
SI-AG5-A3P	12,000	800	85.5/96.5	7.56/18.9	2.49/6.22	25.5	12	1/4	223	217	95	2020
SI-AG5-A3R	12,000	800	85.5/96.5	7.56/18.9	2.49/6.22	30.1	14.2	3/8	219	217	95	2000
SI-AG5-E3L	12,000	800	85.5/96.5	7.56/18.9	2.49/6.22	31.2	14.7	3/8	285	217	95	2080
SI-AG5-E4L	12,000	800	85.5/96.5	7.56/18.9	2.49/6.22	31.2	14.7	3/8	285	217	95	2080
SI-AG5-A3L	12,000	800	85.5/96.5	7.56/18.9	2.49/6.22	31.2	14.7	3/8	285	217	95	2040

Noise levels according to ISO 15744:2008,ISO 11203:2009 Vibration level according to ISO 28927-1

## 7" (180mm) ANGLE DISC GRINDER



### SPINDLE TYPE

**A4** Ø 22.2 - 1/2" - 16UN

**E5** Ø 22.2 - 5/8" - 11UNC

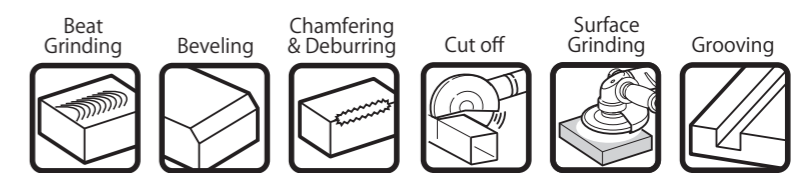

**SI-AG7-E5L**



**SI-AG7-A4R**

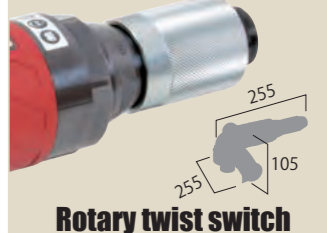

**SI-AG7-A4L**  
**SI-AG7-E5L**

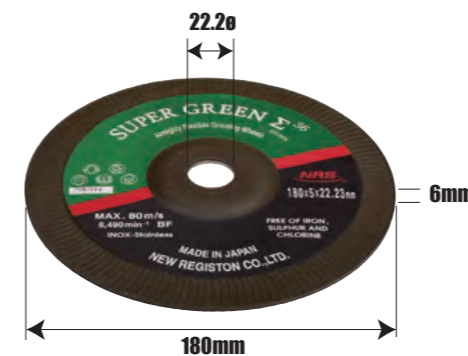

Standard Accessorie  
**Parts No.280-28E**  
**7" Grinding Disc**  
Disc Size : 180×6×22.2mm

### Specifications

SI-No.	Free Speed (rpm)	Motor Watt (w)	Noise Level (db) Press/Power	Vibration(m/s <sup>2</sup> )		Air Consumption		Air Inlet Size (inch)	Length (mm)	Width (mm)	Height (mm)	Weight (g)
				a Body/Grip	K Body/Grip	CFM	(L/sec)					
SI-AG7-A4R	7,600	1,000	84.5/95.5	4.32/6.65	1.39/2.14	19.5	9.2	3/8	255	255	105	2900
SI-AG7-A4L	7,600	1,000	84.5/95.5	4.32/6.65	1.39/2.14	18.1	8.5	3/8	312	255	105	2880
SI-AG7-E5L	7,600	1,000	84.5/95.5	4.32/6.65	1.39/2.14	18.1	8.5	3/8	312	260	135	3300

Noise levels according to ISO 15744:2008,ISO 11203:2009 Vibration level according to ISO 28927-1



## STRAIGHT & COLLET TYPE

### STRAIGHT TYPE DISC GRINDER

#### SPINDLE TYPE

Ø 9.53 - W3/8" - 16

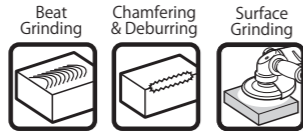

#### Option Accessorie

Parts No.630-W65

Disc Size :  
65 × 13 × 9.53mm  
(SI-SG3-2R & SI-SG3-2L)

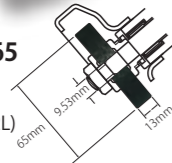

#### Option Accessorie

Parts No.630-W75

Disc Size :  
75 × 13 × 9.53mm  
(SI-SG3-3R & SI-SG3-3L)

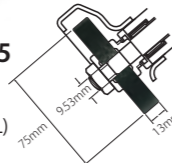

SI-SG3-2L



Palm grip-safety lever

SI-SG3-3L



Palm grip-safety lever

SI-SG3-2R

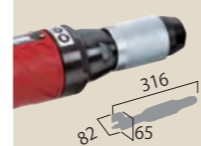

Rotary twist switch

SI-SG3-3R



Rotary twist switch

#### Specifications

SI-No.	Free Speed (rpm)	Motor Watt (w)	Noise Level (db) Press/Power	Vibration(m/s <sup>2</sup> )		Air Consumption		Air Inlet Size (inch)	Length (mm)	Width (mm)	Height (mm)	Weight (g)
				a	K	CFM	L/Sec					
SI-SG3-2L	14,600	520	83.5/94.5	2.86	0.78	14.2	6.7	1/4	316	82	95	1660
SI-SG3-3L	12,700	520	83.5/94.5	2.86	0.78	11.0	5.2	1/4	316	95	102	1685
SI-SG3-2R	14,600	520	83.5/94.5	2.86	0.78	16.0	7.5	3/8	316	82	65	1520
SI-SG3-3R	12,700	520	83.5/94.5	2.86	0.78	12.1	5.7	3/8	316	95	72	1545

Noise levels according to ISO 15744:2008,ISO 11203:2009 Vibration level according to ISO 28927-1

### COLLET TYPE DIE GRINDER

#### COLLET TYPE

Ø 6mm or 1/4"

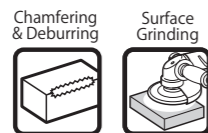

#### Option Attachment

Parts No.129-101(6mm)  
Parts No.129-102(1/4")



#### Option Disc Pad

Parts No.129-100



SI-AG2-C2P-6  
SI-AG2-C2P-Q



Palm grip-safety lever

SI-AG2-C2R-6  
SI-AG2-C2R-Q



Rotary twist switch

#### COLLET TYPE

Ø 6mm or 1/4"

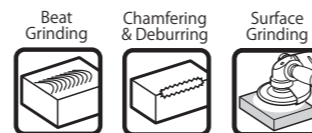

#### Slimline Shaft

The mid-mounted bearing assembly and extended drive shaft design allows access to confined areas where heavy duty cutting power is needed.



SI-SG3-CL-6  
SI-SG3-CL-Q



Palm grip-safety lever

SI-SG3-CR-6  
SI-SG3-CR-Q

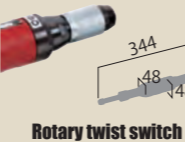

Rotary twist switch

#### Specifications

SI-No.	Free Speed (rpm)	Motor Watt (w)	Noise Level (db) Press/Power	Vibration(m/s <sup>2</sup> )		Air Consumption		Air Inlet Size (inch)	Length (mm)	Width (mm)	Height (mm)	Weight (g)
				a	K	CFM	L/Sec					
SI-AG2-C2P	15,000	240	84/95	7.97	1.28	18.4	8.7	1/4	170	56	90	640
SI-AG2-C2R	15,000	240	84/95	7.97	1.28	18.4	8.7	1/4	157	56	90	650
SI-SG3-CL	14,000	520	83.5/94.5	2.86	0.78	13.1	6.2	1/4	346	48	78	1530
SI-SG3-CR	14,000	520	83.5/94.5	2.86	0.78	13.5	6.3	3/8	344	48	48	1400

Noise levels according to ISO 15744:2008,ISO 11203:2009 Vibration level according to ISO 28927:12

## SI-DS6-5L

### PAD TYPE

5" Leather Pad or 5" Velcro Pad

#### Features

- Large size motor generate high abrasive power and high free speed 11,200 r.p.m.
- Reduced vibration thanks to wide random shaft.
- Ergonomic grip for easy operation.
- short throttle lever makes you feel that the tool is light weight.
- Safety cover mounted for safety use.



The short throttle lever

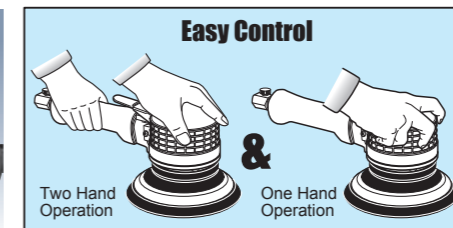

Easy Control

Two Hand Operation

One Hand Operation

The short throttle lever close to center of gravity. Also, easy for one-hand operation.



Wide random shaft reduce the yawing and vibration.



Wide random shaft

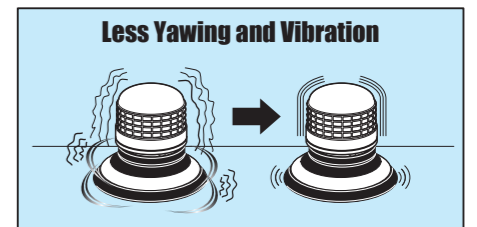

Less Yawing and Vibration

The steel balancer enhance the durability and stable balance.



Durability

Steel Balancer

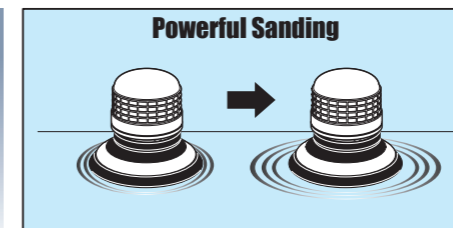

Powerful Sanding

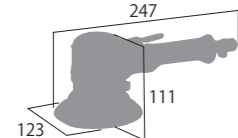

#### Specifications

SI-No.	Pad/Disc Size (mm/in)	Spindle Size	Orbit Dia (mm)	Free Speed (rpm)	Out Put Watt	Weight (kg)	Noise Level dBA/power	Vibration a/k m/s <sup>2</sup>	Air Consumption	
									CFM	L/sec
SI-DS6-5L	125(5")	5/16-24UNF	6	11,200	485	1.54	88.7/(99.7)	7.16/1.36	21.2	10.0

Noise levels according to ISO 15744:2008,ISO 11203:2009 Vibration level according to ISO 28927:12

## High Spec Collet

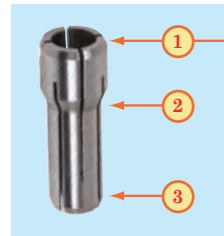

**High Spec Collet**  
Grips at 3 locations.

**Standard Collet**  
Grips at 1 location.

Conventional die grinder collets grip the burr in only one location leaving it susceptible to the effects of "Centre Runout" vibration. The High Spec Collet utilizes its entire length to grip the burr shank, aligning it with the centre of rotation. This reduces vibration which in turn improves control and comfort for the operator and extends the service life of the burr. This is particularly useful when using extended or oversize burrs.

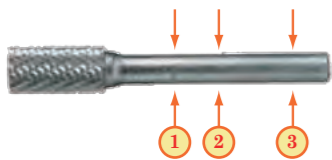

## Gears



**High Precision Bearings & Gears**  
The Shinano Industrial range has been designed with new high tolerance bearings offering low noise and vibration levels and superior performance at high speeds. Precisely ground transmission gears are made from high grade nickel-chromium molybdenum steel with a specialised hardening process. These high quality specifications allow for a more compact design while maintaining heavy duty performance.

## Safety Lever



The safety lever protects from inadvertent starting. When the lever is released, the lever will be locked automatically.

## Rotary Twist Switch(R)



Rotary Twist Switch is suitable for Continuous operation. No switch stress to operators.

## Silencer Hose

In addition to significantly reduced noise levels, the 50 cm silencer hose will also ensure that moisture and oil that may be present in exhaust air are directed away from the work area.

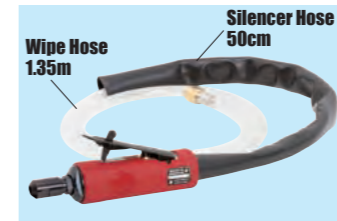

## SI-AG20E-6L-6 (6mm collet) SI-AG20E-6L-Q (1/4" collet)



Free Speed..... 20,000 rpm  
Motor watt..... 200 w  
Weight..... 570 g  
Vibration..... a=2.74 m/s<sup>2</sup>  
K=0.77 m/s<sup>2</sup>

Noise (Press)..... 75.5 db  
Noise (Power)..... 86.5 db  
Air Consumption..... 14.5 CFM  
Air Inlet Size..... 1/4"

## SI-AG20E-6R-6 (6mm collet) SI-AG20E-6R-Q (1/4" collet)



Free Speed..... 20,000 rpm  
Motor watt..... 160 w  
Weight..... 700 g  
Vibration..... a=2.74 m/s<sup>2</sup>  
K=0.77 m/s<sup>2</sup>

Noise (Press)..... 75.5 db  
Noise (Power)..... 86.5 db  
Air Consumption..... 11.1 CFM  
Air Inlet Size..... 1/4"

## SI-SG20E-6L-6 (6mm collet) SI-SG20E-6L-Q (1/4" collet)



Free Speed..... 28,000 rpm  
Motor watt..... 180 w  
Weight..... 380 g  
Vibration..... a=2.81 m/s<sup>2</sup>  
K=0.77 m/s<sup>2</sup>

Noise (Press)..... 75 db  
Noise (Power)..... 86 db  
Air Consumption..... 14.5 CFM  
Air Inlet Size..... 1/4"

## SI-SG20E-6R-6 (6mm collet) SI-SG20E-6R-Q (1/4" collet)



Free Speed..... 26,000 rpm  
Motor watt..... 150 w  
Weight..... 510 g  
Vibration..... a=2.81 m/s<sup>2</sup>  
K=0.77 m/s<sup>2</sup>

Noise (Press)..... 75 db  
Noise (Power)..... 86 db  
Air Consumption..... 10.6 CFM  
Air Inlet Size..... 1/4"

## SI-SG40E-6L-6 (6mm collet) SI-SG40E-6L-Q (1/4" collet)



Free Speed..... 25,000 rpm  
Motor watt..... 450 w  
Weight..... 650 g  
Vibration..... a=4.21 m/s<sup>2</sup>  
K=0.55 m/s<sup>2</sup>

Noise (Press)..... 73.5 db  
Noise (Power)..... 84.5 db  
Air Consumption..... 26.6 CFM  
Air Inlet Size..... 1/4"

## SI-SG60E-6L-6 (6mm collet) SI-SG60E-6L-Q (1/4" collet)



Free Speed..... 25,000 rpm  
Motor watt..... 650 w  
Weight..... 710 g  
Vibration..... a=3.93 m/s<sup>2</sup>  
K=0.88 m/s<sup>2</sup>

Noise (Press)..... 81.5 db  
Noise (Power)..... 92.5 db  
Air Consumption..... 29.4 CFM  
Air Inlet Size..... 1/4"

## Rubberised Extension Tube

All LL series extended die grinders feature a rubberized section of the extension tube which provides extra grip and protection against scuffing of the work piece.

## SI-SG20E-6RL-6 (6mm collet) SI-SG20E-6RL-Q (1/4" collet)



Free Speed..... 26,000 rpm  
Motor watt..... 150 w  
Weight..... 810 g  
Air Consumption..... 10.6 CFM  
Air Inlet Size..... 1/4"

(Body/Grip)  
Vibration..... a=2.01/3.2 m/s<sup>2</sup>  
K=0.69/0.81 m/s<sup>2</sup>  
Noise (Press)..... 77.5 db  
Noise (Power)..... 88.5 db

## SI-SG20E-6LL-6 (6mm collet) SI-SG20E-6LL-Q (1/4" collet)



Free Speed..... 28,000 rpm  
Motor watt..... 180 w  
Weight..... 680 g  
Air Consumption..... 14.5 CFM  
Air Inlet Size..... 1/4"

(Body/Grip)  
Vibration..... a=2.01/3.2 m/s<sup>2</sup>  
K=0.69/0.81 m/s<sup>2</sup>  
Noise (Press)..... 77.5 db  
Noise (Power)..... 88.5 db

## SI-SG40E-6LL-6 (6mm collet) SI-SG40E-6LL-Q (1/4" collet)



Free Speed..... 25,000 rpm  
Motor watt..... 450 w  
Weight..... 1,120 g  
Air Consumption..... 26.6 CFM  
Air Inlet Size..... 1/4"

(Body/Grip)  
Vibration..... a=2.66/3.44 m/s<sup>2</sup>  
K=0.76/0.83 m/s<sup>2</sup>  
Noise (Press)..... 83 db  
Noise (Power)..... 94 db

## SI-SG60E-6LL-6 (6mm collet) SI-SG60E-6LL-Q (1/4" collet)



Free Speed..... 25,000 rpm  
Motor watt..... 650 w  
Weight..... 1,190 g  
Air Consumption..... 29.4 CFM  
Air Inlet Size..... 1/4"

(Body/Grip)  
Vibration..... a=2.44/4.28 m/s<sup>2</sup>  
K=0.74/0.92 m/s<sup>2</sup>  
Noise (Press)..... 80.5 db  
Noise (Power)..... 91.5 db

## Market segments

### For Shipyards



### For Construction



### For Bridge



## IMO PSPC

The Shinano carbide tipped edge cutter is a superior edge finishing solution when compared to conventional edge grinding methods. It can quickly and easily machine consistent beveled or radiused edges that meet and exceed the IMO's PSPC regulations for surface preparation and is suitable for use on aluminium, structural grade steel and most types of stainless steel.

## Features

### Safety cutting method

The edge cutters are cutting the seat metal with hard tip. It is different method of working between the grinders, reduced sparking and rounded corners are safety since risk of injury.

### High quality welding seam

The high quality of the welding seam is a particular advantage. Only one step, that is no need for refreshing and no any working. With our edge cutters can produce clean, burr-free and oxide-free finished edges.

### Original Carbide Tip

The router head features three cutting tips for high stock removal. Each tip gives 8 cutting edges offering a long and economical service life.

### Superior Edge Finishing

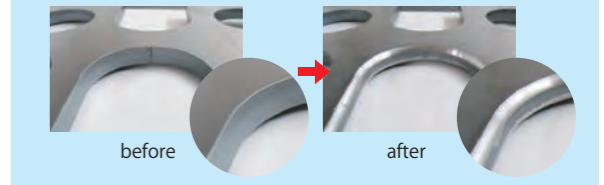

### Cutting range of Operation

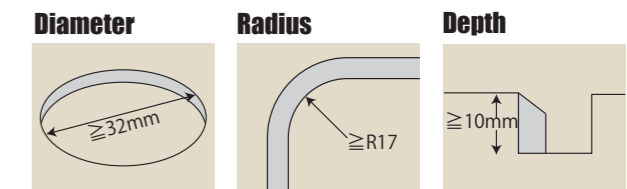

### Thickness

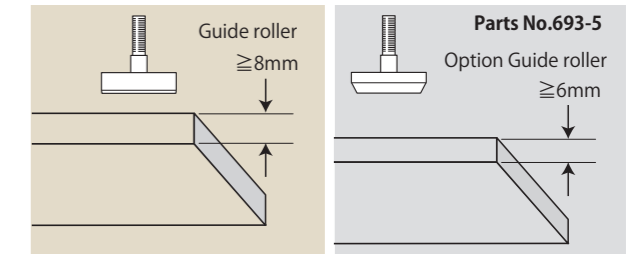

R3 Carbide Tip for rounding the edges  
Parts No.693-17GS

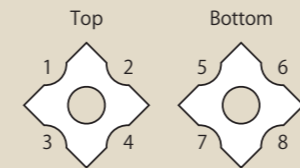

8 position(it can use 8 times)

C3 Carbide Tip for radiusing the edges  
Parts No.693-39GS

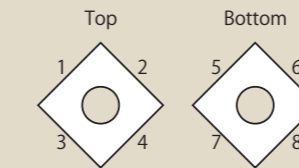

## SI-4010L

Free Speed..... 10,000 rpm  
Motor watt..... 900 w  
Weight..... 3,300 g  
Air Consumption.... 34.0 CFM  
16.00 L/sec  
Air Inlet Size..... 1/4"

## High Power Model



Standard Carbide tips  
Parts No.693-17GS



Optional Carbide tips  
Parts No.693-39GS



## SI-4010



Free Speed..... 10,000 rpm  
Motor watt..... 900 w  
Weight..... 3,360 g  
Air Consumption.... 34.0 CFM  
16.00 L/sec  
Air Inlet Size..... 1/4"

## SI-4011L

Free Speed..... 10,000 rpm  
Motor watt..... 600 w  
Weight..... 2,200 g  
Air Consumption.... 29.1 CFM  
13.67 L/sec  
Air Inlet Size..... 1/4"

## Light Model



Standard Carbide tips  
Parts No.693-17GS



Optional Carbide tips  
Parts No.693-39GS

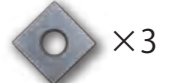

## SI-4011



Free Speed..... 10,000 rpm  
Motor watt..... 600 w  
Weight..... 2,280 g  
Air Consumption.... 29.1 CFM  
13.67 L/sec  
Air Inlet Size..... 1/4"



# SHINANO AIR TOOL ACCESSORIES

## ▶ IMPACT WRENCHES

<b>103-1</b> Muffler  IMPACT WRENCHES	<b>215RA-13</b> Muffler Filter inside  (Quieter than 911P-25) IMPACT WRENCHES	<b>911P-25</b> Muffler  IMPACT WRENCHES	<b>458-58</b> Housing Cover  IMPACT WRENCHES	<b>736-8</b> Muffler Retainer  IMPACT WRENCHES
<b>736DH-10</b> Retainer  IMPACT WRENCHES	<b>911A-15</b> Muffler Retainer  IMPACT WRENCHES	<b>911P-11</b> Retainer  IMPACT WRENCHES	<b>737-26</b> Housing Cover  IMPACT WRENCHES	<b>913-21</b> Housing Cover  IMPACT WRENCHES
<b>967-23</b> Housing Cover  IMPACT WRENCHES				

## ▶ DRIVERS

<b>181-45</b> Regulator  DRIVERS	<b>181-51</b> +Bit  DRIVERS	<b>181-51A</b> +Bit  DRIVERS	<b>458-58</b> Housing Cover  DRIVERS
---	--------------------------------------	---------------------------------------	---

## ▶ SANDERS

<b>10mm Sanding Belt</b> #40/#60/#80/#100/#120  509-45Z/40 10mm Sanding belt #40 509-45Z/60 10mm Sanding belt #60 509-45Z/80 10mm Sanding belt #80 509-45Z/100 10mm Sanding belt #100 509-45Z/120 10mm Sanding belt #120 BELT SANDERS	<b>20mm Sanding Belt</b> #40/#60/#80/#100/#120  507-58Z/40 20mm Sanding belt #40 507-58Z/60 20mm Sanding belt #60 507-58Z/80 20mm Sanding belt #80 507-58Z/100 20mm Sanding belt #100 507-58Z/120 20mm Sanding belt #120 BELT SANDERS	<b>30mm Sanding Belt</b> #40/#60/#80/#100/#120  505-56Z/40 30mm Sanding belt #40 505-56Z/60 30mm Sanding belt #60 505-56Z/80 30mm Sanding belt #80 505-56Z/100 30mm Sanding belt #100 505-56Z/120 30mm Sanding belt #120 BELT SANDERS	<b>10mm Felt Belt</b> #60/#150/#320  509-130 10mm Felt belt #60 509-131 10mm Felt belt #150 509-132 10mm Felt belt #320 BELT SANDERS	<b>13mm Sanding Belt</b> #60  509LK-106 13mm Sanding belt #60 BELT SANDERS
<b>181-45</b> Regulator  BELT SANDERS	<b>1026-51AS</b> Swivel Regulator Male 1/4" Female 1/4"  BELT SANDERS	<b>PE-125H</b> 5" Leather Pad 5/16-24UNF  SANDERS	<b>ME-125H</b> 5" Velcro Pad 5/16-24UNF  SANDERS	<b>PE-125HD</b> 5" Leather Pad with 6holes 5/16-24UNF  SANDERS

## ▶ SANDERS

<b>ME-125HD</b> 5" Velcro Pad with 6holes 5/16-24UNF  SANDERS	<b>P-125H</b> 5" Leather Pad 5/16-24UNF  SANDERS	<b>M-125H</b> 5" Velcro Pad 5/16-24UNF  SANDERS	<b>P-150H</b> 6" Leather Pad 5/16-24UNF  SANDERS	<b>M-150H</b> 6" Velcro Pad 5/16-24UNF  SANDERS
<b>P-150HD 6</b> 6" Leather Pad with 6holes 5/16-24UNF  SANDERS	<b>M-150HD 6</b> 6" Velcro Pad with 6holes 5/16-24UNF  SANDERS	<b>P-150HD 9</b> 6" Leather Pad with 9holes 5/16-24UNF  SANDERS	<b>M-150HD 9</b> 6" Velcro Pad with 9holes 5/16-24UNF  SANDERS	<b>M-150HD 3-9</b> 6" Velcro Pad with 9holes 5/16-24UNF  SANDERS
<b>P-150HD 3-9</b> 6" Leather Pad with 9holes 5/16-24UNF  SANDERS	<b>M-150HDMH</b> 6" Velcro Pad with Mult holes 5/16-24UNF  SANDERS	<b>1041CV-5</b> 6" Velcro Pad Face cover  SANDERS	<b>NP-150-120</b> 6" Net Paper#120  SANDERS	<b>NP-150-240</b> 6" Net Paper#240  SANDERS
<b>486-3</b> 6" Leather Pad 5/16-24UNF  SANDERS	<b>1140-14M</b> 5" Velcro Pad  SANDERS	<b>1140-59M</b> 6" Velcro Pad  SANDERS	<b>P-3003</b> Leather Pad incl. Plate(490-58B)No hole  SANDERS	<b>M-3003</b> Velcro Pad incl. Plate(490-58B)No hole  SANDERS
<b>P-3007</b> Leather Pad incl. Plate(477-44)  SANDERS	<b>M-3007</b> Velcro Pad incl. Plate(477-44)  SANDERS	<b>P-3013D</b> Leather Pad incl. Plate(490-58B)with hole  SANDERS	<b>M-3013D</b> Velcro Pad incl. Plate(490-58B)with hole  SANDERS	<b>475-22</b> Leather Pad  SANDERS
<b>477A-5EL</b> Leather Pad incl 100x180  SANDERS	<b>477A-5EM</b> Velcro Pad incl 100x180  SANDERS	<b>1040-54</b> ø19mm Dust Hose  SANDERS	<b>570-42A</b> ø25mm Dust Hose  SANDERS	<b>485-42</b> Dust Pack  SANDERS

# SHINANO AIR TOOL ACCESSORIES



## SANDERS

<b>136-45</b> 5" Back Disc  SANDERS	<b>820-52</b> 7" Back Disc  SANDERS	<b>170C-27</b> 3" DiscPad  SANDERS	<b>170C-30</b> 4" DiscPad  SANDERS	<b>129-100</b> 2" Disc Pad  SANDERS
<b>118-3</b> Triangle Sanding Pad  SANDERS	<b>240-50</b> Side Handle  SANDERS	<b>1110A-80E</b> ø80mm Velcro Pad(M14 P-2)  SANDERS	<b>M-75H</b> 3" Velcro Pad 5/16-24UNF  SANDERS	<b>M-75HD</b> 3" Velcro Pad with 3holes 5/16-24UNF  SANDERS
<b>MESP-65</b> ø65mm Sanding Disc  SANDERS	<b>262-21MS</b> ø50mm Velcro Pad M6  SANDERS	<b>114DA-12</b> ø75mm Velcro Pad M6  SANDERS	<b>SHP-50M-80</b> ø30mm Sanding Paper  SANDERS	<b>M-20x60/B</b> ø60mm Sponge Buff  SANDERS
<b>M-60</b> ø60mm Wool Buff  SANDERS	<b>119-101</b> ø80mm Sponge Buff  SANDERS	<b>119-102</b> ø80mm Wool Buff  SANDERS	<b>115MB-6S</b> ø30mm SoftPad  SANDERS	<b>115MB-6H</b> ø30mm HardPad  SANDERS
<b>TZ-3000</b> ø30mm Sanding Paper # 3000  SANDERS				

## POLISHERS

<b>M-150H</b> 6" Velcro Pad 5/16-24UNF  POLISHERS	<b>114DA-12</b> ø3" Velcro Pad Thread 6mm  POLISHERS	<b>400E-102</b> Sponge Buff  POLISHERS	<b>M-150</b> Wool Buff  POLISHERS	<b>M-75H</b> 3" Velcro Pad 5/16-24UNF  POLISHERS
--	--	--	--	--

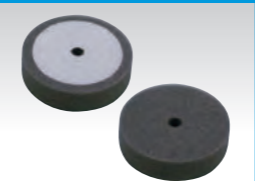
## POLISHERS

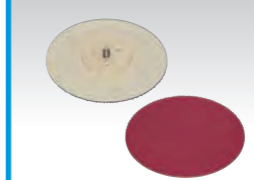
<b>119-101</b> ø80mm Sponge Buff  POLISHERS	<b>119-102</b> ø80mm Wool Buff  POLISHERS	<b>NVP75-120</b> ø75mm Sanding Paper #120  POLISHERS	<b>1145-101</b> ø165mm Wool Buff  POLISHERS	<b>1145-102</b> ø165mm Sponge Buff  POLISHERS
<b>1145-5</b> ø138mm Velcro Pad  POLISHERS	<b>820-52</b> 7" BackDisc  POLISHERS	<b>PW-3100</b> 6" Velcro Pad 5/16-24UNF  POLISHERS		

## GRINDERS

<b>330-24</b> 1/4" Collet  GRINDERS	<b>330-19</b> 6mm Collet  GRINDERS	<b>330-25</b> 1/8" Collet  GRINDERS	<b>330-26</b> 3mm Collet  GRINDERS	<b>175-29</b> 3" Cut Disc  GRINDERS
<b>240-6</b> 4" Disc 15mm Hole  GRINDERS	<b>240-71</b> 4" Disc 16mm Hole  GRINDERS	<b>240C-1</b> Disc Nut for 16mm Hole  GRINDERS	<b>380-44</b> Disc Nut for 15mm Hole  GRINDERS	<b>241-49E</b> 5" Disc  GRINDERS
<b>280-28</b> 7" Disc  GRINDERS	<b>340-57</b> 30mm Grindstone  GRINDERS	<b>340-2A</b> 3mm Collet  GRINDERS	<b>340-2B</b> 1/8" Collet  GRINDERS	<b>340-55</b> ø5mm Grindstone(3mm)  GRINDERS
<b>340-55A</b> ø5mm Grindstone(1/8")  GRINDERS				

# SHINANO AIR TOOL ACCESSORIES









## ▶ DRILLS / SPOT MILLS

<b>KD-004</b> 3/8" Drill Chuck  Chuck / Handle DRILLS / SPOT MILLS	<b>LX10</b> 3/8" Keyless Chuck(Yukiwa)  DRILLS / SPOT MILLS	<b>LM13W</b> 1/2" Keyless Chuck(Yukiwa)  DRILLS / SPOT MILLS	<b>KD-003A</b> 1/2" Drill Chuck  Chuck / Handle DRILLS / SPOT MILLS	<b>KD-002</b> 3/8" Drill Chuck  Chuck / Handle DRILLS / SPOT MILLS
<b>KK</b> Chuck Handle for KD-004, & KD-003A  DRILLS / SPOT MILLS	<b>KG1</b> Chuck Handle for KD-002  DRILLS / SPOT MILLS	<b>100</b> Collet Driver  DRILLS / SPOT MILLS	<b>210-5-1A</b> Dead handle set  DRILLS / SPOT MILLS	<b>271-17</b> ø8mm milling Cutter  DRILLS / SPOT MILLS











## ▶ CUTTING TOOLS

<b>506-49ASI</b> Saw blade 32T  CUTTING TOOLS	<b>1025-49A</b> Saw blade 32T  CUTTING TOOLS	<b>1025-50A</b> Saw blade 24T  CUTTING TOOLS	<b>1026-49A</b> Saw blade 32T  CUTTING TOOLS	<b>506P-56F</b> Flat File  CUTTING TOOLS
<b>506P-56R</b> Round File  CUTTING TOOLS	<b>506P-56T</b> Triangle File  CUTTING TOOLS	<b>1026-50</b> Swivel Regulator Male 1/8" Female 1/4"  CUTTING TOOLS	<b>508-45A</b> Cutting Wheel  CUTTING TOOLS	<b>508-45B</b> Cutting Blade  CUTTING TOOLS
<b>508-44</b> Adjuster  CUTTING TOOLS	<b>502-42</b> Punch  CUTTING TOOLS	<b>502-41</b> Die  CUTTING TOOLS	<b>160-2</b> Center Blade  CUTTING TOOLS	<b>160-3</b> Right Blade  CUTTING TOOLS
<b>160-4</b> Left Blade  CUTTING TOOLS	<b>330-24</b> 1/4" Collet  CUTTING TOOLS	<b>330-19</b> 6mm Collet  CUTTING TOOLS	<b>330-25</b> 1/8" Collet  CUTTING TOOLS	<b>330-26</b> 3mm Collet  CUTTING TOOLS

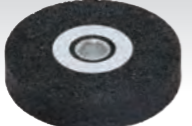
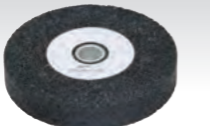
## ▶ OTHERS

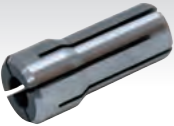
<b>801</b> TIE ROD TOOL .401" Shank CHISELS  Air Hammer	<b>802</b> TAIL PIPE CUTTER .401" Shank CHISELS  Air Hammer	<b>803</b> FORK 21/32" OPENING .401" Shank CHISELS  Air Hammer	<b>803J</b> FORK 15/16" OPENING .401" Shank CHISELS  Air Hammer	<b>804</b> BUSHING REMOVER .401" Shank CHISELS  Air Hammer
<b>805</b> SCRAPER .401" Shank CHISELS  Air Hammer	<b>806</b> BUSHING SPLITTER .401" Shank CHISELS  Air Hammer	<b>807</b> SHEET METAL A .401" Shank CHISELS  Air Hammer	<b>808</b> MUFFER CUTTER .401" Shank CHISELS  Air Hammer	<b>809</b> DOUBLE EDGE PANEL CUTTER .401" Shank CHISELS  Air Hammer
<b>810</b> FLAT 7" LONG .401" Shank CHISELS  Air Hammer	<b>811</b> FLAT 9" LONG .401" Shank CHISELS  Air Hammer	<b>812</b> TAPER PUNCH .401" Shank CHISELS  Air Hammer	<b>813</b> RIVET CUTTER .401" Shank CHISELS  Air Hammer	<b>814</b> BLANK CHISEL .401" Shank CHISELS  Air Hammer
<b>815</b> SPOT WELD BREAKER .401" Shank CHISELS  Air Hammer	<b>816</b> SHEET METAL B .401" Shank CHISELS  Air Hammer	<b>817</b> BUSHING DRIVER .401" Shank CHISELS  Air Hammer	<b>818</b> FLAT BEND .401" Shank CHISELS  Air Hammer	<b>819</b> SHEET METAL PUNCH .401" Shank CHISELS  Air Hammer
<b>820</b> PANEL CLIPPER .401" Shank CHISELS  Air Hammer	<b>821</b> SMOOTHING HAMMER .401" Shank CHISELS  Air Hammer	<b>822</b> STRAIGHT PUNCH .401" Shank CHISELS  Air Hammer	<b>823</b> PAINT SCRAPER .401" Shank CHISELS  Air Hammer	<b>824</b> SHOCK ABSORBER CHISEL .401" Shank CHISELS  Air Hammer
<b>825</b> MOIL POINT .401" Shank CHISELS  Air Hammer	<b>820-11</b> Needles Needle ø3 x 180mm 12Needles / Products  Needle Scaler	<b>820-24</b> Needles Needle ø2 x 180mm 12Needles / Products  Needle Scaler	<b>820-23</b> Needle Holder ø2mm Needle Holder  Needle Scaler	

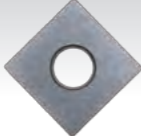
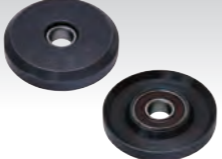
## INDUSTRIAL TOOLS

<b>243-30</b> Disc Pad Attachment  Disc Grinder	<b>129-100</b> 2" Disc Pad  Disc Grinder	<b>243-W50</b> 2" Grinding Disc  Disc Grinder	<b>240-71E</b> 4" Grinding Disc  Disc Grinder	<b>241-49E</b> 5" Grinding Disc  Disc Grinder
<b>280-28E</b> 7" Grinding Disc  Disc Grinder	<b>630-W65</b> 2.5" Grinding Disc  Straight Disc Grinder	<b>630-W75</b> 3" Grinding Disc  Straight Disc Grinder	<b>129-101/129-102</b> 6mm Disc Pad Attachment / 1/4" Disc Pad Attachment  Disc & Die Grinder	<b>114SE-3/114SE-3A</b> 6mm Collet / 1/4" Collet  Die Grinder
<b>892SE-2 / 892SE-2A</b> 6mm Collet / 1/4" Collet  Die Grinder	<b>693-17GS</b> R3 Carbide Tip  Edge Cutter	<b>693-39GS</b> C3 Carbide Tip  Edge Cutter	<b>693-5</b> Guide Roller ≥ 6mm  Edge Cutter	<b>693-5E</b> Guide Roller ≥ 8mm  Edge Cutter

## Exhaust Hose

**TYPE-A**

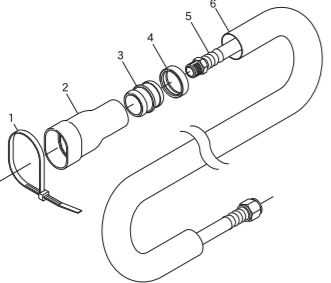

Ref. No.	Parts No.	Description	Q'ty
1	106-10	Harness Band	1
2	106-5	Exhaust Cover A	1
3	106-6	Connector	1
4	106-1	Urethane Band	1
5	106-3	Wipe Hose	1
6	106-2	Exhaust Hose	1
NO.1~6	106-A	Wipe Hose A Assy	1

**TYPE-B**

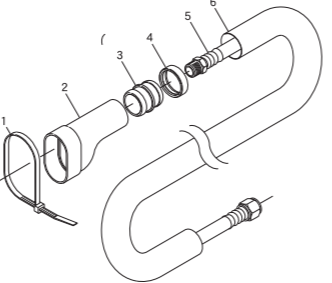

Ref. No.	Parts No.	Description	Q'ty
1	106-10	Harness Band	1
2	106-7	Exhaust Cover B	1
3	106-6	Connector	1
4	106-1	Urethane Band	1
5	106-3	Wipe Hose	1
6	106-2	Exhaust Hose	1
NO.1~6	106-B	Wipe Hose B Assy	1

**TYPE-D**

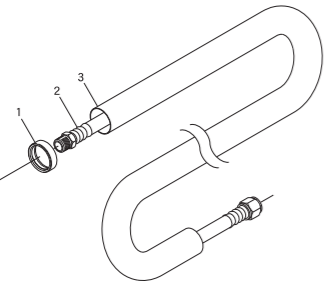

Ref. No.	Parts No.	Description	Q'ty
1	106-1	Urethane Band	1
2	106-3	Wipe Hose	1
3	106-2	Exhaust Hose	1
NO.1~3	106-D	Wipe Hose D Assy	1

**TYPE-S**

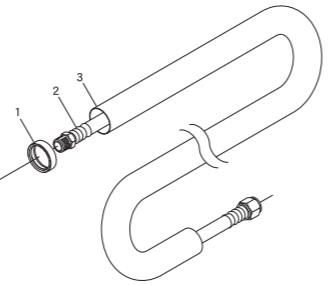

Ref. No.	Parts No.	Description	Q'ty
1	106-8	Urethane Band S	1
2	106-3	Wipe Hose	1
3	106-9	Exhaust Hose S	1
NO.1~3	106-S	Wipe Hose S Assy	1

## ANGLE DISC GRINDERS

SI-No.	Noise Level (dBA)		Vibration Level (m/s <sup>2</sup> )	
	ISO15744		Body/Grip	
	Pressure	Power	a	K
SI-AG2-U2P	84	95	7.97	1.28
SI-AG2-U2R	84	95	7.97	1.28
SI-AG4-E2P	84	95	5.54/13.9	1.8/4.51
SI-AG4-A2P	84	95	5.54/13.9	1.8/4.51
SI-AG4-A2PJ	84	95	5.54/13.9	1.8/4.51
SI-AG4-A2RJ	84	95	5.54/13.9	1.8/4.51
SI-AG4-A2R	84	95	5.54/13.9	1.8/4.51
SI-AG4-A2LJ	84	95	5.54/13.9	1.8/4.51
SI-AG4-A2L	84	95	5.54/13.9	1.8/4.51
SI-AG4-E2L	84	95	5.54/13.9	1.8/4.51
SI-AG5-E3P	85.5	96.5	7.56/18.9	2.49/6.22
SI-AG5-E4P	85.5	96.5	7.56/18.9	2.49/6.22
SI-AG5-A3P	85.5	96.5	7.56/18.9	2.49/6.22
SI-AG5-A3R	85.5	96.5	7.56/18.9	2.49/6.22
SI-AG5-E3L	85.5	96.5	7.56/18.9	2.49/6.22
SI-AG5-E4L	85.5	96.5	7.56/18.9	2.49/6.22
SI-AG5-A3L	85.5	96.5	7.56/18.9	2.49/6.22
SI-AG7-A4R	84.5	95.5	4.32/6.65	1.39/2.14
SI-AG7-A4L	84.5	95.5	4.32/6.65	1.39/2.14
SI-AG7-E5L	84.5	95.5	4.32/6.65	1.39/2.14

## STRAIGHT DISC GRINDERS

SI-No.	Noise Level (dBA)		Vibration Level (m/s <sup>2</sup> )	
	ISO15744		Body/Grip	
	Pressure	Power	a	K
SI-SG3-2L	83.5	94.5	2.86	0.78
SI-SG3-3L	83.5	94.5	2.86	0.78
SI-SG3-2R	83.5	94.5	2.86	0.78
SI-SG3-3R	83.5	94.5	2.86	0.78
SI-SG3-CL	83.5	94.5	2.86	0.78
SI-SG3-CR	83.5	94.5	2.86	0.78

## DIE GRINDERS

SI-No.	Noise Level (dBA)		Vibration Level (m/s <sup>2</sup> )	
	ISO15744		Body/Grip	
	Pressure	Power	a	K
SI-AG2-C2P	84	95	7.97	1.28
SI-AG2-C2R	84	95	7.97	1.28
SI-AG20E-6L	75.5	86.5	2.74	0.77
SI-AG20E-6R	75.5	86.5	2.74	0.77
SI-SG20E-6L	75.5	86	2.81	0.77
SI-SG20E-6LL	77.5	88.5	2.01/3.2	0.77
SI-SG20E-6R	75	86	2.81	0.77
SI-SG20E-6RL	77.5	88.5	2.01/3.2	0.69/0.81
SI-SG40E-6L	73.5	84.5	4.21	0.55
SI-SG40E-6LL	83	94	2.01/3.2	0.69/0.81
SI-SG60E-6L	81.5	92.5	3.93	0.88
SI-SG60E-6LL	80.5	91.5	2.01/3.2	0.69/0.81

## SANDER

SI-No.	Noise Level (dBA)		Vibration Level (m/s <sup>2</sup> )	
	ISO15744		Body/Grip	
	Pressure	Power	a	K
SI-DS6-5L	88.7	99.7	7.16	1.36





## IMPACT WRENCHES

No.	VIBRATION LEVEL			Sound pressure	Sound power	
	ISO 8662	ISO 28927				ISO 15744
		a	K			
SI-1310S	<2.5	4.8	0.9	86	97	
SI-1315S	<2.5	4.9	1.0	86	97	
SI-1355	3.1	3.3	0.8	80	91	
SI-1365	3.3	8.3	1.3	91	102	
SI-1305	7.4	3.8	0.8	91	102	
SI-1650AH	9.4	18.1	2.2	91	102	
SI-1420T	3.2	7.3	1.2	91	102	
SI-1422T	3.8	8.2	1.3	92	103	
SI-1610	4.0	8.6	1.3	94	105	
SI-1610SR	4.0	8.6	1.3	94	105	
SI-1460	-	9.5	1.4	88	99	
SI-1460SR	-	9.5	1.4	88	99	
SI-1490B	4.8	8.6	1.3	94	105	
SI-1490BSR	4.8	8.6	1.3	94	105	
SI-1357	11.3	7.6	1.2	92	103	
SI-1457	11.3	9.1	1.4	92	103	
SI-1605	4.0	8.6	1.3	94	105	
SI-1605SR	4.0	8.6	1.3	94	105	
SI-1492B	5.8	8.6	1.3	94	105	
SI-1492BSR	5.8	8.6	1.3	94	105	
SI-1550	9.1	11.2	1.6	92	103	
SI-1550SR	9.1	11.2	1.6	92	103	
SI-1556	9.1	11.1	1.5	93	104	
SI-1556SR	9.1	11.1	1.5	93	104	
SI-1555SR	9.1	11.2	1.6	92	103	
SI-1860	8.9	8.8	1.3	94	105	
SI-1866	8.9	8.3	1.3	95	106	
SI-1870	9.1	9.3	1.4	94	105	
SI-1876	9.1	12.1	1.7	94	105	
SI-1878	9.1	11.1	1.5	94	105	
SI-1880	8.7	8.3	1.3	92	103	
SI-1888	8.7	9.8	1.4	92	103	
SI-1900	9.3	-	-	107	116	

## DRIVERS

No.	VIBRATION LEVEL			Sound pressure	Sound power	
	ISO 8662	ISO 28927				ISO 15744
		a	K			
SI-1052	4.1	9.3	1.4	90	101	
SI-1062	4.0	9.8	1.4	87	98	
SI-1060	4.0	10.8	2.8	89	100	
SI-1065	5.0	6.9	2.0	88	99	
SI-1356D	3.3	6.6	1.1	87	98	
SI-1365D	3.3	7.6	2.6	84	95	
SI-1070	<2.5	6.4	2.1	83	94	
SI-1170	4.0	0.8	0.5	85	96	
SI-1140	4.5	0.2	0.5	80	91	
SI-1161	<2.5	0.3	0.5	85	96	
SI-1166A	<2.5	0.4	0.5	88	99	
SI-1166-8A	<2.5	1.0	0.6	91	102	

## RATCHET WRENCHES

No.	VIBRATION LEVEL			Sound pressure	Sound power	
	ISO 8662	ISO 28927				ISO 15744
		a	K			
SI-1107B	<2.5	6.1	1.1	77	88	
SI-1108B	<2.5	6.4	1.1	77	88	
SI-1217EX	3.5	4.0	0.9	84	95	
SI-1218EX	3.5	4.5	0.9	88	99	
SI-1200B	3.5	3.6	0.8	82	93	
SI-1205B	3.5	5.7	1.0	82	93	
SI-1251	3.5	4.0	0.8	75	86	
SI-1252	3.5	3.9	0.8	75	86	
SI-1261	7.0	5.1	1.0	84	95	
SI-1262	7.0	5.0	1.0	84	95	
SI-1320A	7.6	6.3	1.1	89	100	
SI-1325A	8.6	6.3	1.1	89	100	
SI-1241A	7.6	11.3	1.6	83	94	
SI-1340EX	7.6	4.2	0.9	82	93	
SI-1345EX	7.6	4.1	0.9	82	93	
SI-1435	9.7	5.4	1.0	93	104	
SI-1288	6.3	6.8	1.1	84	95	

## SANDERS

No.	VIBRATION LEVEL			Sound pressure	Sound power	
	ISO 8662	ISO 28927				ISO 15744
		a	K			
SI-2740	<2.5	1.0	0.6	85	96	
SI-2700	<2.5	2.2	0.7	86	99	
SI-2700L	<2.5	2.5	0.7	83	94	
SI-2700LS	<2.5	1.6	0.6	84	95	
SI-2800	<2.5	3.0	0.8	84	95	
SI-2830	<2.5	1.6	0.6	86	97	
SI-3121-6	-	13.4	1.8	81	92	
SI-3121	-	12.8	1.7	81	92	
SI-3101LG	-	13.7	1.8	88	99	
SI-3111LG	-	13.7	1.8	88	99	
SI-3103A	<2.5	10.6	1.5	80	91	
SI-3103-6A	<2.5	11.5	1.6	80	91	
SI-3113A	<2.5	13.6	1.8	83	94	
SI-3113-6A	<2.5	13.2	2.9	83	94	
SI-3101	<2.5	14.4	1.9	84	95	
SI-3101-6	<2.5	10.4	2.3	84	95	
SI-3111	<2.5	10.2	1.5	88	99	
SI-3111-6	<2.5	11.7	1.6	88	99	
SI-3118A	<2.5	9.0	1.4	81	92	
SI-3118-6A	<2.5	10.1	1.5	81	92	
SI-3115R	<2.5	11.2	1.6	86	97	
SI-3115R-6	<2.5	9.7	2.9	86	97	
SI-3103B	5.5	15.6	2.0	87	98	
SI-3100	4.2	10.2	1.5	75	86	
SI-3102M	<2.5	7.4	1.2	85	96	
SI-3112M	<2.5	6.6	1.1	92	103	
SI-3001A	<2.5	6.2	1.1	82	93	
SI-3011A	<2.5	7.4	1.5	83	94	
SI-3003A	<2.5	6.9	1.1	75	86	
SI-3013	<2.5	4.6	0.9	88	99	
SI-3005	<2.5	21.1	2.8	88	99	
SI-3007	<2.5	27.5	3.2	86	97	
SI-3018A	<2.5	10.2	1.5	83	94	
SI-3003B	<2.5	4.6	0.9	88	99	
SI-2026	<2.5	3.4	0.8	88	99	
SI-2351	<2.5	4.9	0.9	80	91	
SI-2008EX	<2.5	4.0	0.9	83	94	
SI-2107A	<2.5	3.8	0.9	85	96	
SI-2108EX	<2.5	18.5	2.3	85	96	
SI-2108EX-2	<2.5	18.5	2.3	85	96	
SI-2210	<2.5	3.8	1.0	91	102	
SI-2201	<2.5	2.2	0.7	82	93	
SI-2201-2	<2.5	2.2	0.7	82	93	
SI-2202-2	<2.5	2.3	0.7	82	93	
SI-2202	<2.5	2.3	0.7	82	93	
SI-2110S	<2.5	9.5	2.1	82	93	
SI-2300	<2.5	1.4	0.6	82	93	
SI-3200A	<2.5	9.6	2.2	83	94	
SI-2322WR-LE	<2.5	1.7	0.6	88	99	
SI-3310	<2.5	10.2	2.1	83	94	



## POLISHERS

No.	VIBRATION LEVEL			Sound pressure	Sound power	
	ISO 8662	ISO 28927				ISO 15744
		a	K			
SI-2415	<2.5	13.1	5.6	86	97	
SI-3100P	5.3	6.7	3.1	75	86	
SI-2221	<2.5	1.4	0.6	83	94	
SI-2224S	<2.5	1.6	0.6	83	94	
SI-2009EX	<2.5	1.1	0.6	77	88	
SI-2009H	<2.5	2.3	0.7	77	88	
SI-2400	<2.5	1.8	0.6	83	94	
SI-2405	<2.5	1.8	1.0	84	95	
SI-2451	<2.5	2.2	0.7	83	94	

## GRINDERS

No.	VIBRATION LEVEL			Sound pressure	Sound power	
	ISO 8662	ISO 28927				ISO 15744
		a	K			
SI-2001S	<2.5	3.4	0.8	84	95	
SI-2001S-6	<2.5	3.4	0.8	84	95	
SI-2002EX	<2.5	2.3	0.7	84	95	
SI-2002EX-6	<2.5	2.3	0.7	84	95	
SI-2011S	<2.5	6.5	1.1	87	98	
SI-2011S-6	<2.5	6.5	1.1	87	98	
SI-2012EX	<2.5	3.9	1.3	87	98	
SI-2012EX-6	<2.5	3.9	1.3	87	98	
SI-2015A	<2.5	4.9	0.9	88	99	
SI-2015A-6	<2.5	4.9	0.9	88	99	
SI-2010	<2.5	5.9	1.0	83	94	
SI-2010-6	<2.5	5.9	1.0	83	94	
SI-2005HD	-	7.3	1.2	81	92	
SI-2005HD-6	-	7.3	1.2	81	92	
SI-2006S	3.9	7.4	1.6	83	94	
SI-2006S-6	3.9	7.4	1.6	83	94	
SI-2033	<2.5	7.5	2.4	89	100	
SI-2022S	<2.5	4.1	0.9	89	100	
SI-2022S-6	<2.5	4.1	0.9	89	100	
SI-2023	<2.5	4.0	0.9	90	101	
SI-2023-6	<2.5	4.0	0.9	90	101	
SI-2501L	5.7	9.6	3.1	81	92	
SI-2501	5.7	8.4	2.8	82	93	
SI-2500L	2.9	9.9	3.2	80	91	
SI-2500	2.9	7.6	2.5	84	95	
SI-2515LA	2.9	11.0	3.6	85	96	
SI-2505L	2.8	5.8	1.9	82	93	
SI-2515WE	-	11.0	3.6	85	96	
SI-2600L	<2.5	4.0	1.3	97	108	
SI-2050AG	<2.5	0.9	0.3	71	82	
SI-2051SG	<2.5	1.2	0.6	71	82	



## DRILLS

No.	VIBRATION LEVEL			Sound pressure	Sound power	
	ISO 8662	ISO 28927				ISO 15744
		a	K			
SI-2015AD	<2.5	2.6	0.7	86	97	
SI-5100A	<2.5	3.4	0.8	84	95	
SI-5200A	<2.5	3.0	1.0	82	93	
SI-5300A	<2.5	2.0	0.7	84	95	
SI-5305A	<2.5	4.7	0.9	90	101	
SI-5305-8A	<2.5	6.0	1.6	91	102	
SI-5501	<2.5	2.6	0.7	80	91	
SI-5506	<2.5	1.9	0.6	80	91	
SI-5405	<2.5	2.9	0.9	80	91	
SI-5405-6	<4.0	3.4	0.8	82	93	
SI-5500	<2.5	2.8	0.7	85	96	
SI-5505	<2.5	2.5	0.7	80	91	
SI-5355	<2.5	3.2	0.8	84	95	
SI-5360	-	2.2	0.8	81	92	
SI-5365	-	1.7	0.7	82	94	
SI-5800	<2.5	-	-	82	93	
SI-5850	<2.5	-	-	83	94	

## CUTTING TOOLS

No.	VIBRATION LEVEL			Sound pressure	Sound power	
	ISO 8662	ISO 28927				ISO 15744
		a	K			
SI-4700B	8.0	22.6	2.7	82	93	
SI-4730	8.0	15.1	1.9	86	97	
SI-4710	7.9	21.0	1.5	85	97	
SI-4710F	7.9	21.0	1.5	85	97	
SI-4740	8.4	14.5	1.9	83	94	
SI-4740F	8.4	14.5	1.9	83	94	
SI-4600	<2.5	8.6	1.3	88	99	
SI-4500	4.0	4.9	0.9	83	94	
SI-2018A	<2.5	-	-	87	98	
SI-2018A-6	<2.5	-	-	87	98	
SI-4300	4.0	4.8	0.9	88	99	

## OTHERS

No.	VIBRATION LEVEL			Sound pressure	Sound power	
	ISO 8662	ISO 28927				ISO 15744



## OPERATING ENVIRONMENT

In order to have a tool operate safely and with satisfactory performance, please read the following information thoroughly before considering which SI tool is right for your application.

## WORK STATIONS

The tools in this catalogue are intended to be used as a hand-held tool only. It is always recommended that the operator uses the tool in a standing position on a solid floor. These tools can be used in other positions, but before any such use, the operator must ensure they are in a secure position holding the tool firmly and following extra safety precautions that may be required by your workplace.

## AIR SUPPLY SYSTEM

To ensure that SI pneumatic tools perform as expected it is necessary to ensure the air supply to the tool is setup correctly. Compressed air must be supplied to the tool at a pressure of 90 PSI (0.63 mpa) when the tool is running with the trigger fully depressed.

Shinano Inc. recommends air regulators, filters, lubricator and water traps be installed in the air supply system. Hose diameter and length can effect the performance of some high capacity pneumatic tools. It is important that the correct hoses and fittings be used. Details of such equipment can be obtained from your pneumatic tool supplier.

It is recommended that the pneumatic tools are connected to an air supply system with a configuration as shown in the diagram below. DO NOT connect a pneumatic tool to the airline system without incorporating an easy to reach and operate air shut off valve. Ensure the air supply system can support the tool(s) that will be connected to it. An air filter, regulator and lubricator units should be installed to the air supply system that powers your pneumatic tools.

DESCRIPTION	
Pressure at the working	0.63MPa (90PSI 6.3bar)
Max Hose Length	10m (30ft)
Lubrication	Daily Lubricating oil

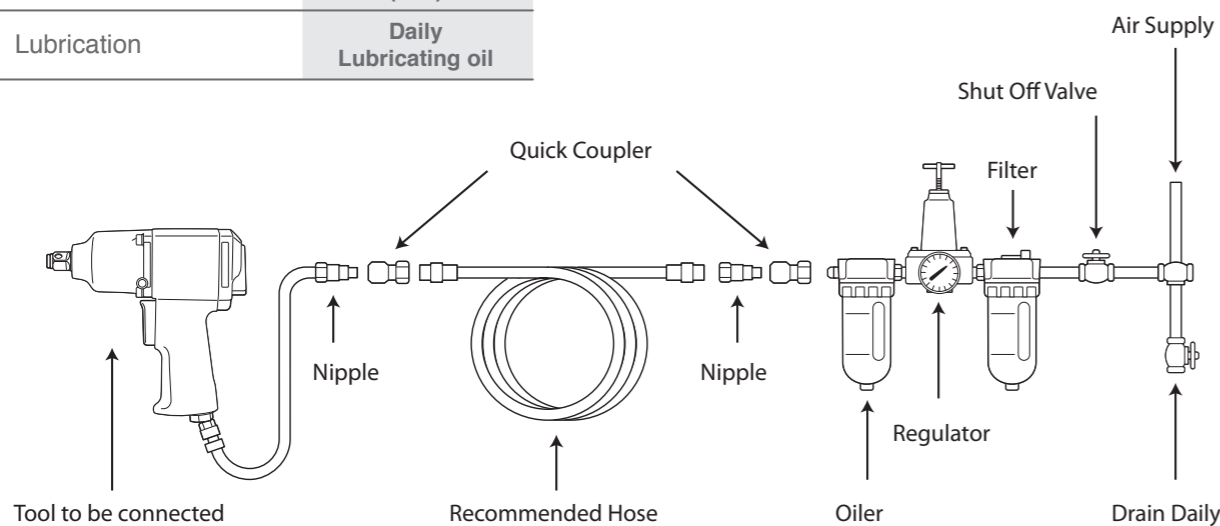

## PLANNING AND DEVELOPMENT

Our product development team analyse industry data for the planning of new tools.



## DESIGN

Our designs are drawn from over 45 years experience in pneumatic tool design and production, extensive industry research, sound engineering & ergonomic principles and employing modern production techniques.

In our design process, we carefully study the properties and function of each part. We examine the manufacturing parameters of an assembled component, then test for strength and performance.

Shinano Inc. collects data by conducting test experiments in the fields of operator safety, health and workplace productivity. Our designers always aim for perfection in their designs which will in-turn build on the strengths of the SI product range.



## PRODUCTION

We believe that precision robotics, combined with the management systems of the human mind produce high quality products at a reasonable price. Our production lines incorporate fully automatic robotics, to accurately, rapidly and efficiently manufacture our products.



## CERTIFYING OUR STANDARDS OF QUALITY

Component inspection is carefully carried out at a number of production stages. Inspectors ensure that the production meets the required quality and durability standards. Constant vigilance and daily production inspections ensure the high quality of Shinano Inc. air tools.

